



CATALOGO GENERALE
MASTER CATALOGUE

TUBI SETTORE OLEODINAMICO

Cap. 1: Tubi Gomma Alta Pressione.....	7
Cap. 2: Tubi Gomma "SUPER POWER".....	19
Cap. 3: Tubi Gomma Alta Temperatura.....	35
Cap. 4: Tubi Termoplastici	41
Cap. 5: Tubi Altissima Pressione.....	55
Cap. 6: Tubi Gomma Bassa/Media Press.....	61

TUBI SETTORE INDUSTRIALE

Cap. 7: Tubi Olii & Carburanti	71
Cap. 8: Tubi Acqua & Fluidi non Corrosivi.....	87
Cap. 9: Tubi Aria	97
Cap. 10: Tubi per Acqua Calda & Vapore	107
Cap. 11: Tubi Atossici Alimentari.....	117
Cap. 12: Tubi Prodotti Chimici.....	131
Cap. 13: Tubi per Materiali Abrasivi.....	137
Cap. 14: Tubi Applicazioni Varie	147

TUBI SETTORE NAUTICO

Cap. 15: Tubi Omologati per Nautica.....	153
--	-----

TUBI TRECCIATI

Cap. 16: Tubi Trecciati Esternamente	165
--	-----

ACCESSORI PER TUBI

Cap. 17: Protezioni & Accessori per Tubi	177
--	-----

RACCORDI PER TUBO FLESSIBILE

Cap. 18: Boccole & Raccordi Standard	201
Cap. 19: Sistema WEO	225
Cap. 20: Boccole & Raccordi Interlock.....	231
Cap. 21: Programma Alta Press. 700 bar	243
Cap. 22: Boccole & Raccordi Recuperabili	249
Cap. 23: Boccole & Raccordi Bassa Pressione.....	259

ADATTATORI DI COLLEGAMENTO

Cap.24: Adattatori BSP/BSPT/NPT	265
Cap.25: Adattatori JIC 37°	291
Cap.26: Adattatori ORFS	311
Cap.27: Adattatori JIS 60°	321
Cap.28: Adattatori Idropulitrice.....	325
Cap.29: Adattatori Serie "ASA"	329
Cap.30: Adattatori "Flange SAE"	333

ACCESSORI PER IL FISSAGGIO

Cap. 31: Rondelle & O-Rings.....	341
Cap. 32: Fascette Stringitubo	355

TUBI RIGIDI & RACCORDI DIN

Cap. 33: Tubi Rigidi per circuiti oleodinamici	365
Cap. 34: Raccordi ad Anello DIN 2353.....	369
Cap. 35: Collari Fermatubo	411

COMPONENTI OLEODINAMICI

Cap. 36: Innesti Rapidi	415
Cap. 37: Valvole/Giunti Girevoli/Distribut.....	435
Cap. 38: Manometri & Accessori.....	447

FRENI & ARIA CONDIZIONATA

Cap. 39: Tubo & Raccordi per Freni	461
Cap. 40: Tubo Rame & Accessori.....	483
Cap. 41: Tubi & Raccordi per Aria Condizionata	487

PNEUMATICA

Cap. 42: Tubi Rilsan	493
Cap. 43: Accessori per Pneumatica	503

LUBRIFICAZIONE

Cap. 44: Ingrassaggio.....	521
Cap. 45: Olio	529

FOCUS SETTORIALI

Cap. 46: Aria Compressa Cantieri	535
Cap. 47: Spurgo.....	543
Cap. 48: Carrelli Elevatori.....	561
Cap. 49: Officine Trucks	565
Cap. 50: Focus Cisterne Carburante	569
Cap. 51: Guarnizioni per Oleodinamica & Pneumatica.....	575
Cap. 52: Macchinari & Attrezzatura	581

APPENDICE TECNICA:

Cap. 53: Appendice Tecnica	588
----------------------------------	-----

HYDRAULIC SECTION HOSES

Chap. 1: High Pressure Hydraulic Hoses 7
 Chap. 2: "SUPER POWER" Hydraulic Hoses 19
 Chap. 3: High Temperature H.P. Hydraulic Hoses 35
 Chap. 4: Thermoplastic Hoses 41
 Chap. 5: Ultra-High Pressure Hoses 55
 Chap. 6: Low/Medium Pressure Hoses 61

INDUSTRIAL SECTION HOSES

Chap. 7: Oils & Fuels Hoses 71
 Chap. 8: Water & noncorr. Fluids Hoses 87
 Chap. 9: Air Hoses 97
 Chap. 10: Hot Water & Steam Hoses 107
 Chap. 11: Nontoxic & Alimentary Hoses 117
 Chap. 12: Chemicals Products Hoses 131
 Chap. 13: Abrasives Materials Hoses 137
 Chap. 14: Various Applications Hoses 147

NAUTICAL SECTION HOSES

Chap. 15: Nautical Approved Hoses 153

BRAIDS HOSES

Chap. 16: External Braids Hoses 165

HOSES ACCESSORIES

Chap. 17: Hoses Protections & Accessories 177

FLEXIBLE HOSE FITTINGS

Chap. 18: Standard Ferrules & Fittings 201
 Chap. 19: WEO System 225
 Chap. 20: Interlock Ferrules & Fittings 231
 Chap. 21: 700 bar High Pressure Program 243
 Chap. 22: Reusable Ferrules & Fittings 249
 Chap. 23: Low Pressure Ferrules & Fittings 259

CONNECTING ADAPTORS

Chap.24: BSP/BSPT/NPT Adaptors 265
 Chap.25: JIC 37° Adaptors 291
 Chap.26: ORFS Adaptors 311
 Chap.27: JIS 60° Adaptors 321
 Chap.28: Cleaners Adaptors 325
 Chap.29: "ASA" Series Adaptors 329
 Chap.30: "SAE Flanges" Adaptors 333

FIXING ACCESSORIES

Chap. 31: Gaskets & O-Rings 341
 Chap. 32: Pipe / Cable Clamps 355

STEEL TUBES & DIN FITTINGS

Chap. 33: Oleodynamic Plants Tubes 365
 Chap. 34: Fittings with ring DIN 2353 369
 Chap. 35: Clamps 411

HYDRAULICS COMPONENTS

Chap. 36: Quick Release Coupligs 415
 Chap. 37: Valves/Swivel Joints/Distribut 435
 Chap. 38: Pressure Gauges & Accessories 447

BRAKE & CONDITIONING AIR

Chap. 39: Brake Hose & Fittings 461
 Chap. 40: Copper Tube & Accessories 483
 Chap. 41: Air Conditioning Hoses & Fittings 487

PNEUMATIC

Chap. 42: Rilsan Tubes 493
 Chap. 43: Pneumatic Accessories 503

LUBRIFICATION

Chap. 44: Greasing 521
 Chap. 45: Oil 529

SECTORIAL FOCUS

Chap. 46: Compres. Air Construction Sites 535
 Chap. 47: Sewer Jetting 543
 Chap. 48: Forklifts 561
 Chap. 49: Trucks Workshops 566
 Chap. 50: Fuel Tank Trucks Focus 566
 Chap. 51: Hydraulic & Pneumatic Seals 574
 Chap. 52: Machinery & Equipments 580

TECHNICAL APPENDIX

Cap. 53: Technical Appendix 585



TUBI GOMMA ALTA PRESSIONE
HIGH PRESSURE RUBBER HOSES

TUBI IDRAULICI
HYDRAULIC HOSES



IMPIEGO

TUBO ALTA PRESSIONE 1SN per olii idraulici, minerali e „biologici”, olii a base poliglicole, acqua, emulsioni olio/acqua.

- Temperatura: -40°C +100°C con punte di 120°C

STRUTTURA

- Sottostrato: liscio in gomma nera sintetica oleoresistente.
- Rinforzi: **1 treccia acciaio alta resistenza.**
- Copertura: gomma sintetica con ottima resistenza all'abrasione, ozono, olio ed all'invecchiamento.
- Normative: ISO 1436 / DIN EN 853 – 1SN / SAE J517 - SAE 100 R1AT
- Marcatura: **Valcon® Quality Hydraulics**

Fornibile a richiesta con rivestimenti in acciaio zincato o acciaio inox.

APPLICATION

HIGH PRESSURE 1SN HOSE for hydraulic mineral and „biological” oils, polyglycol base oil, water, oil/water emulsions.

- Temperature range: -40°C +100°C peak of +120°C

CONSTRUCTION

- Tube: black, smooth, resistant synthetic rubber.
- Reinforcement: **1 high tensile steel wire braid.**
- Cover: abrasion, weather, ozone and oil resistant synthetic black rubber.
- According to: ISO 1436 / DIN EN 853 – 1 SN / SAE J517 - SAE 100 R1AT
- Branding: **Valcon® Quality Hydraulics**

Available on request with coverings: galvanized and stainless steel braids.



Codice Part Number	Diametro Interno Inside Diameter			Ø Esterno O.D.	Pr. Esercizio Max WP	Pr. Scoppio Burst Pr.	Raggio Curv. Bend Radius	Peso Weight	Boccola Ferrule	Lunghezza Lenght
	DN	Inch	mm							
100 051 316	5	3/16"	4,8	11,8	250	1000	89	0,230	014 120 316	25-50-100
100 051 140	6	1/4"	6,3	13,4	225	900	100	0,260	014 120 140	25-50-100
100 051 516	8	5/16"	8	15	215	850	114	0,300	014 120 516	25-50-100
100 051 380	10	3/8"	9,5	17,4	180	720	127	0,360	014 120 380	25-50-100
100 051 120	12	1/2"	12,7	20,7	160	640	178	0,460	014 120 120	25-50-100
100 051 580	16	5/8"	16	23,8	130	520	200	0,560	014 120 580	10-25-50
100 051 340	19	3/4"	19	27,8	105	420	240	0,740	014 120 340	10-25-50
100 051 100	25	1"	25,4	35,9	88	350	300	1,060	014 120 100	10-20-40
100 051 114	31	1.1/4"	32	43,8	63	250	419	1,360	014 120 114	10-20-40
100 051 112	38	1.1/2"	38	51,1	50	200	500	1,650	014 120 112	10-20-40
100 051 200	50	2"	50,8	64,5	40	160	630	2,050	014 120 200	10-20-40
100 051 212	60	2.1/2"	63,5	79	30	120	760	2,890	014 120 212	a richiesta
100 051 300	76	3"	76,2	92	20	80	900	3,430	014 120 300	a richiesta



IMPIEGO

TUBO ALTA PRESSIONE 2SN per olii idraulici, minerali e „biologici”, olii a base poliglicole, acqua, emulsioni olio/acqua.

- Temperatura: -40°C +100°C con punte di 120°C

STRUTTURA

- Sottostrato: liscio in gomma nera sintetica oleoresistente.
- Rinforzi: **2 treccie acciaio alta resistenza.**
- Copertura: gomma sintetica con ottima resistenza all'abrasione, ozono, olio ed all'invecchiamento.
- Normative: ISO 1436 / DIN EN 853 – 2SN / SAE J517- SAE 100 R2AT
- Marcatura: **Valcon® Quality Hydraulics**

Fornibile a richiesta con rivestimenti in acciaio zincato o acciaio inox.

APPLICATION

HIGH PRESSURE 2SN HOSE for hydraulic mineral and „biological” oils, polyglycol base oil, water, oil/water emulsions.

- Temperature range: -40°C +100°C peak of +120°C

CONSTRUCTION

- Tube: black, smooth, resistant synthetic rubber.
- Reinforcement: **2 high tensile steel wire braids.**
- Cover: abrasion, weather, ozone and oil resistant synthetic black rubber.
- According to: ISO 1436 / DIN EN 853 – 2SN / SAE J517 - SAE 100 R2AT
- Branding: **Valcon® Quality Hydraulics**

Available on request with coverings: galvanized and stainless steel braids.



Codice Part Number	Diametro Interno Inside Diameter			Ø Esterno O.D.	Pr. Esercizio Max WP	Pr. Scoppio Burst Pr.	Raggio Curv. Bend Radius	Peso Weight	Boccola Ferrule	Lunghezza Lenght
	DN	Inch	mm							
100 052 316	5	3/16"	4,8	13,4	415	1650	89	0,320	014 120 316	25-50-100
100 052 140	6	1/4"	6,3	15	400	1600	100	0,380	014 120 140	25-50-100
100 052 516	8	5/16"	8	16,6	350	1400	114	0,450	014 120 516	25-50-100
100 052 380	10	3/8"	9,5	19	330	1320	127	0,530	014 120 380	25-50-100
100 052 120	12	1/2"	12,7	22,2	275	1100	178	0,650	014 120 120	25-50-100
100 052 580	16	5/8"	16	25,5	250	1000	200	0,760	014 120 580	10-25-50
100 052 340	19	3/4"	19	29,4	215	860	240	1,000	014 120 340	10-25-50
100 052 100	25	1"	25,4	37,9	165	650	300	1,480	014 120 100	10-25-50
100 052 114	31	1.1/4"	32	48,5	125	500	419	2,140	014 120 114	10-20-40
100 052 112	38	1.1/2"	38	54,7	90	360	500	2,550	014 120 112	10-20-40
100 052 200	50	2"	50,8	67,4	80	320	630	3,300	014 120 200	10-20-40
100 052 212	60	2.1/2"	63,5	83	70	280	760	3,960	014 120 212	a richiesta
100 052 300	76	3"	76,2	96	55	220	900	4,960	014 120 300	a richiesta



IMPIEGO

TUBO ALTA PRESSIONE 1SC per olii idraulici, minerali e "biologici", olii a base poliglicole, acqua, emulsioni olio/acqua.

- Temperatura: -40°C +100°C con punte di 120°C

STRUTTURA

- Sottostrato: gomma nera sintetica oleoresistente.
- Rinforzi: **1 treccia acciaio alta resistenza.**
- Copertura: gomma sintetica nera con ottima resistenza agli oli ed alle condizioni ambientali.
- Normative: ISO 11237-1 / DIN EN 857 – 1SC
- Marcatura: **Valcon® Quality Hydraulics**

Fornibile a richiesta con rivestimenti in acciaio zincato o acciaio inox.

APPLICATION

HIGH PRESSURE 1SC HOSE for mineral oils, vegetable and rapeseed oils, glycol and polyglycol based oils, synthetic ester based oils, oils in aqueous emulsion, water.

- Temperature range: -40°C +100°C peak of +120°C

CONSTRUCTION

- Tube: oil resistant synthetic rubber.
- Reinforcement: **1 high tensile steel wire braid.**
- Cover: black, oil and environment resistant synthetic rubber.
- According to: ISO 11237-1 / DIN EN 857 – 1SC
- Branding: **Valcon® Quality Hydraulics**

Available on request with coverings: galvanized and stainless steel braids.



Codice Part Number	Diametro Interno Inside Diameter			Ø Esterno O.D.	Pr. Esercizio Max WP	Pr. Scoppio Burst Pr.	Raggio Curv. Bend Radius	Peso Weight	Boccola Ferrule	Lunghezza Lenght
	DN	Inch	mm							
100 101 140	6	1/4"	6,4	12,2	225	900	50	0,175	014 100 140	25-50-100
100 101 516	8	5/16"	7,9	13,5	215	860	55	0,220	014 100 516	25-50-100
100 101 380	10	3/8"	9,5	13,6	180	720	60	0,280	014 100 380	25-50-100
100 101 120	12	1/2"	12,8	19,1	160	640	70	0,345	014 101 120	25-50-100
100 101 580	16	5/8"	15,9	22,4	130	520	90	0,430	014 100 580	10-25-50
100 101 340	19	3/4"	19	26	105	420	100	0,520	014 100 340	10-25-50
100 101 100	25	1"	25,4	31,4	88	352	160	0,850	014 100 100	10-25-50

⚠ Taglio a misura applicato sovrapprezzo di 15,00 euro / Cut to size applied supplement of 15,00 euro



IMPIEGO

TUBO ALTA PRESSIONE 1SC per olii idraulici, minerali e "biologici", olii a base poliglicole, acqua, emulsioni olio/acqua.

- Temperatura: -40°C +100°C con punte di 120°C

STRUTTURA

- Sottostrato: gomma nera sintetica oleoresistente.
- Rinforzi: **1 treccia acciaio alta resistenza.**
- Copertura: gomma sintetica nera con ottima resistenza agli oli ed alle condizioni ambientali.
- Normative: ISO 11237-1 / DIN EN 857 – 1SC
- Marcatura: **Gates® PROIT**

Fornibile a richiesta con rivestimenti in acciaio zincato o acciaio inox.

APPLICATION

HIGH PRESSURE 1SC HOSE for mineral oils, vegetable and rapeseed oils, glycol and polyglycol based oils, synthetic ester based oils, oils in aqueous emulsion, water.

- Temperature range: -40°C +100°C peak of +120°C

CONSTRUCTION

- Tube: oil resistant synthetic rubber.
- Reinforcement: **1 high tensile steel wire braid.**
- Cover: black, oil and environment resistant synthetic rubber.
- According to: ISO 11237-1 / DIN EN 857 – 1SC
- Branding: **Gates® PROIT**

Available on request with coverings: galvanized and stainless steel braids.



Codice Part Number	Diametro Interno Inside Diameter			Ø Esterno O.D.	Pr. Esercizio Max WP	Pr. Scoppio Burst Pr.	Raggio Curv. Bend Radius	Peso Weight	Boccola Ferrule	Lunghezza Lenght
	DN	Inch	mm							
100 551 140	6	1/4"	6,4	12,5	225	900	75	0,190	014 100 140	varie - 50
100 551 516	8	5/16"	7,9	13,6	215	860	85	0,210	014 100 516	varie - 50
100 551 380	10	3/8"	9,5	15,8	180	720	90	0,280	014 100 380	varie - 50
100 551 120	12	1/2"	12,8	19,0	160	640	130	0,340	014 101 120	varie - 50
100 551 580	16	5/8"	15,9	22,5	130	520	150	0,430	014 100 580	varie - 50
100 551 340	19	3/4"	19	25,9	105	420	180	0,500	014 100 340	varie - 50
100 551 100	25	1"	25,4	33,4	88	352	230	0,820	014 100 100	varie - 50

● Fornibile in 7 gg lavorativi / Available in 7 working days ⚠ Taglio a misura applicato sovrapprezzo di 15,00 euro / Cut to size applied supplement of 15,00 euro



IMPIEGO

TUBO ALTA PRESSIONE 2SC per olii idraulici, minerali e "biologici", olii a base poliglicole, acqua, emulsioni olio/acqua.

- Temperatura: -40°C +100°C con punte di 120°C

STRUTTURA

- Sottostrato: liscio in gomma nera sintetica oleoresistente.
- Rinforzi: **2 trecce acciaio alta resistenza.**
- Copertura: gomma sintetica con ottima resistenza all'abrasione, ozono, olio ed all'invecchiamento.
- Normative: ISO 11237-1 / DIN EN 857 – 2SC
- Marcatura: **Valcon® Quality Hydraulics**

Fornibile a richiesta con rivestimenti in acciaio zincato o acciaio inox.

APPLICATION

HIGH PRESSURE 2SC HOSE for hydraulic mineral and "biological" oils, polyglycol base oil, water, oil/water emulsions.

- Temperature range: -40°C +100°C peak of +120°C

CONSTRUCTION

- Tube: black, smooth, resistant synthetic rubber.
- Reinforcement: **2 high tensile steel wire braids.**
- Cover: abrasion, weather, ozone and oil resistant synthetic black rubber.
- According to: ISO 11237-1 / DIN EN 857 – 2SC
- Branding: **Valcon® Quality Hydraulics**

Available on request with coverings: galvanized and stainless steel braids.



Codice Part Number	Diametro Interno Inside Diameter			Ø Esterno O.D.	Pr. Esercizio Max WP	Pr. Scoppio Burst Pr.	Raggio Curv. Bend Radius	Peso Weight	Boccola Ferrule	Lunghezza Lenght
	DN	Inch	mm							
100 452 140	6	1/4"	6,4	13,5	400	1600	75	0,287	014 120 140	25-50-100
100 452 516	8	5/16"	7,9	15,4	350	1400	85	0,346	014 120 516	25-50-100
100 452 380	10	3/8"	9,6	17	330	1320	90	0,417	014 120 380	25-50-100
100 452 120	12	1/2"	12,7	21	275	1100	130	0,557	014 120 120	25-50-100
100 452 580	16	5/8"	15,9	23,6	250	1000	170	0,656	014 120 580	25-50
100 452 340	19	3/4"	19	28,0	215	860	200	0,828	014 120 340	25-50
100 452 100	25	1"	25,4	35,9	165	660	250	1,250	014 120 100	25-50



IMPIEGO

TUBO ALTA PRESSIONE 2SC per olii idraulici, minerali e "biologici", olii a base poliglicole, acqua, emulsioni olio/acqua.

- Temperatura: -40°C +100°C con punte di 120°C

STRUTTURA

- Sottostrato: liscio in gomma nera sintetica oleoresistente.
- Rinforzi: **2 trecce acciaio alta resistenza.**
- Copertura: **LISCIA** in gomma sintetica con ottima resistenza all'abrasione, olio ed all'invecchiamento.
- Normative: ISO 11237-1 / DIN EN 857 – 2SC
- Marcatura: **Gates® PROV**

Fornibile a richiesta con rivestimenti in acciaio zincato o acciaio inox.

APPLICATION

HIGH PRESSURE 2SC HOSE for hydraulic mineral and „biological“ oils, polyglycol base oil, water, oil/water emulsions.

- Temperature range: -40°C +100°C peak of +120°C

CONSTRUCTION

- Tube: seamless oil resistant synthetic rubber.
- Reinforcement: **2 high tensile steel wire braids.**
- Cover: oil, weather and abrasion **SMOOTH** resistant synthetic black rubber.
- According to: ISO 11237-1 / DIN EN 857 – 2SC
- Branding: **Gates® PROV**

Available on request with coverings: galvanized and stainless steel braids.



Codice Part Number	Diametro Interno Inside Diameter			Ø Esterno O.D.	Pr. Esercizio Max WP	Pr. Scoppio Burst Pr.	Raggio Curv. Bend Radius	Peso Weight	Boccola Ferrule	Lunghezza Lenght
	DN	Inch	mm							
100 552 140	6	1/4"	6,3	12,8	400	1600	50	0,270	014 120 140	varie - 50
100 552 516	8	5/16"	8	14,7	350	1400	55	0,300	014 120 516	varie - 50
100 552 380	10	3/8"	9,5	16,6	330	1320	65	0,330	014 120 380	varie - 50
100 552 120	12	1/2"	12,7	20,3	276	1104	90	0,460	014 120 120	varie - 50
100 552 580	16	5/8"	15,9	23,6	250	1000	100	0,540	014 120 580	varie - 50
100 552 340	19	3/4"	19	27,4	215	860	120	0,670	014 120 340	varie - 50
100 552 100	25	1"	25,4	35,4	165	660	150	1,020	014 120 100	varie - 50



IMPIEGO

TUBO ALTA PRESSIONE 2SC per olii idraulici, minerali e „biologici“, olii a base poliglicole, acqua, emulsioni olio/acqua.
• Temperatura: -40°C +100°C con punte di 120°C

STRUTTURA

- Sottostrato: liscio in gomma nera sintetica oleoresistente.
- Rinforzi: **2 trecce acciaio alta resistenza.**
- Copertura: **LISCIA** in gomma sintetica con ottima resistenza all'abrasione, olio ed all'invecchiamento.
- Normative: ISO 11237-1 / DIN EN 857 – 2SC

Fornibile a richiesta con rivestimenti in acciaio zincato o acciaio inox.

LUNGHEZZE FISSE

APPLICATION

HIGH PRESSURE 2SC HOSE for hydraulic mineral and „biological“ oils, polyglycol base oil, water, oil/water emulsions.
• Temperature range: -40°C +100°C peak of +120°C

CONSTRUCTION

- Tube: seamless oil resistant synthetic rubber.
- Reinforcement: **2 high tensile steel wire braids.**
- Cover: oil, weather and abrasion **SMOOTH** resistant synthetic black rubber.
- According to: ISO 11237-1 / DIN EN 857 – 2SC

Available on request with coverings: galvanized and stainless steel braids.

FIXED LENGTHS



Codice Part Number	Diametro Interno Inside Diameter			Ø Esterno O.D.	Pr. Esercizio Max WP	Pr. Scoppio Burst Pr.	Raggio Curv. Bend Radius	Peso Weight	Boccola Ferrule	Lunghezza Length
	DN	Inch	mm							
100 080 120	12	1/2"	12,7	20,5	276	1104	90	0,520	014 120 120	80
100 100 120	12	1/2"	12,7	20,5	276	1104	90	0,520	014 120 120	100
100 120 120	12	1/2"	12,7	20,5	276	1104	90	0,520	014 120 120	120
100 080 340	19	3/4"	19	27,9	215	860	120	0,800	014 120 340	80
100 100 340	19	3/4"	19	27,9	215	860	120	0,800	014 120 340	100
100 120 340	19	3/4"	19	27,9	215	860	120	0,800	014 120 340	120
100 080 100	25	1"	25,4	36	165	660	150	1,220	014 120 100	80
100 100 100	25	1"	25,4	36	165	660	150	1,220	014 120 100	100
100 120 100	25	1"	25,4	36	165	660	150	1,220	014 120 100	120



IMPIEGO

TUBO ALTA PRESSIONE 4SP per Olii idraulici, minerali e „biologici“, olii a base poliglicole, acqua, emulsioni olio/acqua.
• Temperatura: -40°C +100°C con punte di 120°C

STRUTTURA

- Sottostrato: liscio in gomma nera sintetica oleoresistente.
- Rinforzi: **4 spirali acciaio alta resistenza.**
- Copertura: gomma sintetica con ottima resistenza all'abrasione, ozono, olio ed all'invecchiamento.
- Normative: ISO 3862 / EN 856 - 4SP
- Marcatura: **Valcon® Quality Hydraulics**

Fornibile a richiesta con rivestimenti in acciaio zincato o acciaio inox.

APPLICATION

HIGH PRESSURE 4SP HOSE for hydraulic mineral and „biological“ oils, polyglycol base oil, water, oil/water emulsions.
• Temperature range: -40°C +100°C peak of +120°C

CONSTRUCTION

- Tube: black, smooth, resistant synthetic rubber.
- Reinforcement: **4 high tensile steel spirals.**
- Cover: abrasion, weather, ozone and oil resistant synthetic black rubber.
- According to: ISO 3862 / EN 856 - 4SP
- Branding: **Valcon® Quality Hydraulics**

Available on request with coverings: galvanized and stainless steel braids.



Codice Part Number	Diametro Interno Inside Diameter			Ø Esterno O.D.	Pr. Esercizio Max WP	Pr. Scoppio Burst Pr.	Raggio Curv. Bend Radius	Peso Weight	Boccola Ferrule	Lunghezza Length
	DN	Inch	mm							
100 154 140	6	1/4"	6,6	17,9	500	2000	120	0,7	014 802 140	10-20-40
100 154 380	10	3/8"	9,5	21,4	445	1780	130	0,8	014 802 380	10-20-40
100 154 120	12	1/2"	12,7	23	420	1680	180	1,15	014 802 120	10-20-40
100 154 580	16	5/8"	16	26,7	350	1400	225	1,26	014 802 580	10-20-40
100 154 340	19	3/4"	19	33	350	1400	280	1,44	014 802 340	10-20-40
100 154 100	25	1"	25,4	41	280	1120	355	2,15	014 802 100	10-20-40
100 154 114	31	1.1/4"	32	51,2	210	840	460	2,75	014 802 114	10-20-40
• 100 154 112	38	1.1/2"	38	57,2	185	740	560	3,35	014 802 112	a richiesta
• 100 154 200	50	2"	50,8	69,8	165	660	710	4,6	014 802 200	a richiesta



IMPIEGO

TUBO ALTA PRESSIONE 4SH per Olii idraulici, minerali e "biologici", olii a base poliglicole, acqua, emulsioni olio/acqua.

- Temperatura: -40°C +100°C con punte di 120°C

STRUTTURA

- Sottostrato: liscio in gomma nera sintetica oleoresistente
- Rinforzi: **4 spirali acciaio alta resistenza.**
- Copertura: gomma sintetica con ottima resistenza all'abrasione, ozono, olio ed all'invecchiamento.
- Normative: ISO 3862 / EN 856 - 4SH
- Marcatura: **Valcon® Quality Hydraulics**

Fornibile a richiesta con rivestimenti in acciaio zincato o acciaio inox.

APPLICATION

HIGH PRESSURE 4SH HOSE for hydraulic mineral and „biological“ oils, polyglycol base oil, water, oil/water emulsions.

- Temperature range: -40°C +100°C peak of +120°C

CONSTRUCTION

- Tube: black, smooth, resistant synthetic rubber.
- Reinforcement: **4 high tensile steel spirals.**
- Cover: abrasion, weather, ozone and oil resistant synthetic black rubber.
- According to: ISO 3862 / EN 856 - 4SH
- Branding: **Valcon® Quality Hydraulics**

Available on request with coverings: galvanized and stainless steel braids.



Codice Part Number	Diametro Interno Inside Diameter			Ø Esterno O.D.	Pr. Esercizio Max WP	Pr. Scoppio Burst Pr.	Raggio Curv. Bend Radius	Peso Weight	Boccola Ferrule	Lunghezza Lenght
	DN	Inch	mm							
100 254 340	19	3/4"	19	31	420	1680	280	1,6	014 611 340	10-20-40
100 254 100	25	1"	25,4	37,7	385	1540	340	2,06	014 611 100	10-20-40
100 254 114	31	1.1/4"	32	44,2	350	1400	460	2,566	014 611 114	10-20-40
100 254 112	38	1.1/2"	38	54,6	300	1200	560	3,42	014 611 112	10-20-40
4SH50	50	2"	50,8	68,1	250	1000	700	4,5	014 611 200	< 6,5

4SH50 Altre lunghezze a richiesta/ Other lenght on request



IMPIEGO

TUBO ALTA PRESSIONE R13 per Olii idraulici, minerali e "biologici", olii a base poliglicole, acqua, emulsioni olio/acqua.

- Temperatura: -40°C +100°C con punte di 120°C

STRUTTURA

- Sottostrato: liscio in gomma nera sintetica oleoresistente
- Rinforzi: **4/6 spirali acciaio alta resistenza.**
- Copertura: gomma sintetica con ottima resistenza all'abrasione, ozono, olio ed all'invecchiamento.
- Normative: ISO 3862 / EN 856 - R13 / SAE J517 - SAE 100 R13

Fornibile a richiesta con rivestimenti in acciaio zincato o acciaio inox.

APPLICATION

HIGH PRESSURE R13 HOSE for hydraulic mineral and „biological“ oils, polyglycol base oil, water, oil/water emulsions.

- Temperature range: -40°C +100°C peak of +120°C

CONSTRUCTION

- Tube: black, smooth, resistant synthetic rubber.
- Reinforcement: **4/6 high tensile steel spirals.**
- Cover: abrasion, weather, ozone and oil resistant synthetic black rubber.
- According to: ISO 3862 / EN 856 - R13 / SAE J517 - SAE 100 R13

Available on request with coverings: galvanized and stainless steel braids.



Codice Part Number	Diametro Interno Inside Diameter			Ø Esterno O.D.	Pr. Esercizio Max WP	Pr. Scoppio Burst Pr.	Raggio Curv. Bend Radius	Peso Weight	Boccola Ferrule	Lunghezza Lenght
	DN	Inch	mm							
• 100 013 340	19	3/4"	19,0	33,0	420	1680	280	1,560	014 611 340	40 - 60
• 100 013 100	25	1"	25,4	38,7	380	1520	340	2,090	014 611 100	40 - 60
• 100 013 114	31	1.1/4"	32,0	49,8	345	1380	420	3,900	014 610 114	40 - 60
• 100 013 112	38	1.1/2"	38,0	57,4	345	1380	500	4,960	014 610 112	40 - 60
R13-50	50	2"	50,8	71,1	345	1380	635	7,090	014 610 200	< 4,5

R13-50 Altre lunghezze a richiesta/ Other lenght on request



IMPIEGO

TUBO ALTA PRESSIONE R15 per Olii idraulici, minerali e "biologici", olii a base poliglicole, acqua, emulsioni olio/acqua.

- Temperatura: -40°C +100°C con punte di 120°C

STRUTTURA

- Sottostrato: liscio in gomma nera sintetica oleoresistente
- Rinforzi: **4/6 spirali acciaio alta resistenza.**
- Copertura: gomma sintetica con ottima resistenza all'abrasione, ozono, olio ed all'invecchiamento.
- Normative: ISO 3862 / EN 856 - R15 / SAE J517 - SAE 100 R15

Fornibile a richiesta con rivestimenti in acciaio zincato o acciaio inox.

APPLICATION

HIGH PRESSURE R15 HOSE for hydraulic mineral and „biological“ oils, polyglycol base oil, water, oil/water emulsions.

- Temperature range: -40°C +100°C peak of +120°C

CONSTRUCTION

- Tube: black, smooth, resistant synthetic rubber.
- Reinforcement: **4/6 high tensile steel spirals.**
- Cover: abrasion, weather, ozone and oil resistant synthetic black rubber.
- According to: ISO 3862 / EN 856 - R15 / SAE J517 - SAE 100 R15

Available on request with coverings: galvanized and stainless steel braids.



Codice Part Number	Diametro Interno Inside Diameter		Ø Esterno O.D.	Pr. Esercizio Max WP	Pr. Scoppio Burst Pr.	Raggio Curv. Bend Radius	Peso Weight	Boccola Ferrule	Lunghezza Lenght	
	DN	Inch								mm
R15-20	19	3/4"	19,0	36,1	420	1680	255	1,560	014 611 340	< 15
R15-25	25	1"	25,4	42,9	420	1680	330	2,100	014 611 100	< 14
R15-32	31	1.1/4"	32,0	51,5	420	1680	445	3,650	014 610 114	< 9
R15-40	38	1.1/2"	38,0	59,6	420	1680	530	5,000	014 610 112	< 7
100 015 340	19	3/4"	19,0	32,2	420	1680	280	1,560	014 611 340	20 - 40 - 60
100 015 100	25	1"	25,4	38,7	420	1680	340	2,090	014 611 100	20 - 40 - 60
100 015 114	31	1.1/4"	32,0	51,5	420	1680	445	3,650	014 610 114	20 - 40
100 015 112	38	1.1/2"	38,0	59,6	420	1680	530	5,000	014 610 112	20 - 40

Altre lunghezze a richiesta/ Other lenght on request



TUBI GOMMA ALTA PRESSIONE
HIGH PRESSURE RUBBER HOSES

TUBI SUPER POWER
SUPER POWER HYDRAULIC HOSES



IMPIEGO

TUBO ALTA PRESSIONE Olii idraulici, minerali e “biologici”, olii a base poliglicole, acqua, emulsioni olio/acqua.

Tubo Premium estremamente flessibile e compatto.

- Temperatura: -40°C +100°C

STRUTTURA

- Sottostrato: liscio in gomma nera sintetica oleoresistente
- Rinforzi: **una treccia acciaio alta resistenza.**
- Copertura: gomma sintetica con ottima resistenza al calore, abrasione, ozono, olio ed all'invecchiamento.
- Normative: **SAE100R16 & 100R17* per dimensioni & performance; EN853 2SN and EN857 2SC per performance.**
- Marcatura: **MXT GATES™**

APPLICATION

HIGH PRESSURE R1AT HOSE for hydraulic mineral and „biological” oils, polyglycol base oil, water, oil/water emulsions.

Extremely flexible and compact premium hose.

- Temperature range: -40°C +100°C

CONSTRUCTION

- Tube: black, smooth, resistant synthetic rubber.
- Reinforcement: **one high tensile steel wire braid.**
- Cover: heat, abrasion, weather, ozone and oil resistant synthetic, rubber.
- According to: **SAE100R16 & 100R17* dimension & performance; EN853 2SN and EN8572SC**
- Branding: **MXT GATES™**



Codice Part Number	Diametro Interno Inside Diameter			Ø Esterno O.D.	Pr. Esercizio Max WP	Pr. Scoppio Burst Pr.	Raggio Curv. Bend Radius	Peso Weight	Boccola Ferrule	Lunghezza Lenght
	DN	Inch	mm							
MXT06	6	1/4"	6,4	13,7	414	1.656	48	0,300	014 120 140	20 - 40
MXT08	8	5/16"	7,9	15,2	380	1.520	55	0,330	014 120 516	20 - 40
MXT10	10	3/8"	9,5	17,1	330	1.320	64	0,390	014 120 380	20 - 40
MXT12	12	1/2"	12,8	20,2	275	1.100	70	0,460	014 120 120	20 - 40
MXT16	16	5/8"	16,0	24,0	250	1.000	75	0,570	014 120 580	20 - 40
MXT20	19	3/4"	19,0	27,4	215	860	120	0,700	014 120 340	20 - 40
MXT25	25	1"	25,4	35,1	165	660	152	1,000	014 120 100	20 - 40

Altre lunghezze a richiesta/ Other length on request

GATES® MXT™

Utilizzando materiali innovativi e tecnologie di progettazione all'avanguardia, Gates è riuscita con questo prodotto a sviluppare un tubo idraulico versatile, leggero e molto flessibile. Il risultato: l'installazione del tubo è semplificata e il tempo di installazione è ridotto senza compromettere le prestazioni. La flessibilità e il raggio di curvatura di questo prodotto non hanno eguali!



- Impiego universale, anche come alternativa di tubi idraulici a 2 treccie metalliche (diametro esterno ridotto)
- Raggio di curvatura estremamente ridotto: il migliore sul mercato che garantisce una flessibilità unica (migliorativo rispetto ai tubi 1SC)
- La maggiore flessibilità garantisce fino al 40% in meno di forza necessaria per raggiungere il raggio di curvatura minimo - questo permette un montaggio più facile e veloce
- Fino al 30% più leggero dei tubi idraulici standard, quindi montaggio più agevole e peso di stoccaggio ridotto (particolarmente interessante per utilizzo nei fasci di tubi).
- Copertura esterna liscia, con conseguente minore abrasione quando si utilizzano più tubi flessibili in situazioni di installazione in spazi ristretti

⚠ Taglio a misura applicato sovrapprezzo di 15,00 euro / Cut to size applied supplement of 15,00 euro



IMPIEGO

TUBO ALTA PRESSIONE SPFLEX MEGASYS per Olii idraulici, minerali e "biologici", olii a base poliglicole, acqua, emulsioni olio/acqua.

Particolarmente indicato dove occorrono raggi di curvatura estremamente stretti.

- Temperatura: -40°C +121°C

STRUTTURA

- Sottostrato: liscio in gomma nera oleoresistente.
- Rinforzi: **4/6 SPIRALI in acciaio alta resistenza** (qualità ottimizzata con resistenza massima).
- Copertura: Gomma sintetica liscia nera speciale, altamente resistente all'usura, all'ozono ed all'abrasione.
- Marcatura: GATES® MEGASYS®
- Certificazioni: MSHA-DNV-GL-LR-BV-ABS

Fornibile a richiesta con rivestimenti in acciaio zincato o acciaio inox.

APPLICATION

HIGH PRESSURE SPFLEX MEGASYS for hydraulic mineral and „biological“ oils, polyglycol base oil, water, oil/water emulsions.

Particularly suitable where it takes extremely tight radii of curvature.

- Temperature range: -40°C +121°C

CONSTRUCTION

- Tube: black, smooth, resistant synthetic rubber.
- Reinforcement: **4/6 high tensile steel spirals** (optimized quality with maximum strength).
- Cover: Black synthetic rubber special, highly wear-resistant, ozone and abrasion.
- Branding: GATES® MEGASYS®
- Approvals: MSHA-DNV-GL-LR-BV-ABS

Available on request with coverings: galvanized and stainless steel braids.



Codice Part Number	Diametro Interno Inside Diameter		Ø Esterno Pr. Esercizio O.D. Max WP		Pr. Scoppio Burst Pr.	Raggio Curv. Bend Radius	Boccola Indunorm®	Boccola Ferrule	Lunghezza Lenght	
	DN	Inch	mm	mm						bar
SPFLEX20M	19	3/4"	19,0	31,4	420	1680	120	HV12	014 611 340	20 - 40
SPFLEX25M	25	1"	25,4	38,7	420	1680	150	HV16	014 611 100	20 - 40
SPFLEX32M	32	1.1/4"	32,0	50,0	420	1680	210	HV20	014 611 114	20 - 40



SPFLEX MEGASYS™ GATES®

**RAGGI DI CURVATURA RIDOTTI AL 50%
RISPETTO ALLE NORME EN 856 4SH**



VANTAGGI:

- Tubazione multi-spirale con alta flessibilità;
- Raggi di curvatura molto stretti che non ostruiscono la tubazione;
- Combinazione ottimale tra raggio di curvatura e pressione di esercizio;
- Alta resistenza all'abrasione;
- Alta flessibilità in piccoli spazi.

SETTORI DI UTILIZZO:

- Macchine Movimento Terra;
- Edilizia pesante;
- Demolizione;
- Alti livelli di pressione con carico d'impulso.

CARATTERISTICHE:

- Eccellente flessibilità;
- Raggi di curvatura estremamente ridotti;
- Elevata resistenza agli impulsi;
- Massima pressione con il minimo raggio di curvatura;
- Utilizzo dei raccordi serie XV in combinazione con l'anello Indulock®;
- Sistema antistrappo garantito con boccola corta;
- Ottimizzazione delle scorte di magazzino.

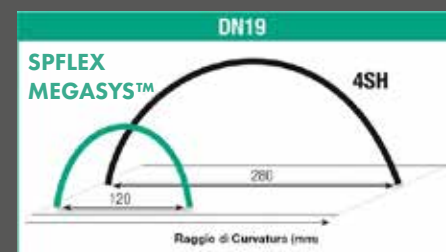

Confronto tra SPFLEX MEGASYS™ e 4SH

- SIGNIFICATAMENTE PIÙ FLESSIBILE
- RAGGI DI CURVATURA RIDOTTI PIÙ DEL 50%
- FINO A 10 VOLTE PIÙ RESISTENTE ALL'ABRASIONE



IMPIEGO

TUBO ALTA PRESSIONE SPFLEX MEGASYS per Olii idraulici, minerali e "biologici", olii a base poliglicole, acqua, emulsioni olio/acqua.

Particolarmente indicato dove occorrono raggi di curvatura estremamente stretti.

- Temperatura: -40°C +120°C

STRUTTURA

- Sottostrato: liscio in gomma nera oleoresistente.
- Rinforzi: **4/6 SPIRALI in acciaio alta resistenza** (qualità ottimizzata con resistenza massima).
- Copertura: Gomma sintetica liscia nera speciale, altamente resistente all'usura, all'ozono ed all'abrasione.
- Marcatura: INDUNORM ISOFLEX 6000
- Certificazioni: MSHA-DNV-GL-LR-BV-ABS

Fornibile a richiesta con rivestimenti in acciaio zincato o acciaio inox.

APPLICATION

HIGH PRESSURE SPFLEX MEGASYS for hydraulic mineral and „biological“ oils, polyglycol base oil, water, oil/water emulsions.

Particularly suitable where it takes extremely tight radii of curvature.

- Temperature range: -40°C +120°C

CONSTRUCTION

- Tube: black, smooth, resistant synthetic rubber.
- Reinforcement: **4/6 high tensile steel spirals** (optimized quality with maximum strength).
- Cover: Black synthetic rubber special, highly wear-resistant, ozone and abrasion.
- Branding: INDUNORM ISOFLEX 6000
- Approvals: MSHA-DNV-GL-LR-BV-ABS

Available on request with coverings: galvanized and stainless steel braids.



Codice Part Number	Diametro Interno Inside Diameter		Ø Esterno Pr. Esercizio Pr. Scoppio		Pr. Scoppio Burst Pr.	Raggio Curv. Bend Radius	Boccola Indunorm®	Boccola Ferrule	Lunghezza Length	
	DN	Inch	mm	mm						bar
SPFLEX20	19	3/4"	19,0	31,4	420	1680	210	HV12	HAN4-12	< 2
SPFLEX25	25	1"	25,4	38,2	420	1680	250	HV16	HAN4-16	< 15
SPFLEX32	32	1.1/4"	32,0	49,3	420	1680	445	HV20	HAN6-20	< 9

SPFLEX MEGASYS™ GATES®

RAGGI DI CURVATURA RIDOTTI AL 50% RISPETTO ALLE NORME EN 856 4SH



VANTAGGI:

- Tubazione multi-spirale con alta flessibilità;
- Raggi di curvatura molto stretti che non ostruiscono la tubazione;
- Combinazione ottimale tra raggio di curvatura e pressione di esercizio;
- Alta resistenza all'abrasione;
- Alta flessibilità in piccoli spazi.

SETTORI DI UTILIZZO:

- Macchine Movimento Terra;
- Edilizia pesante;
- Demolizione;
- Alti livelli di pressione con carico d'impulso.

CARATTERISTICHE:

- Eccellente flessibilità;
- Raggi di curvatura estremamente ridotti;
- Elevata resistenza agli impulsi;
- Massima pressione con il minimo raggio di curvatura;
- Utilizzo dei raccordi serie XV in combinazione con l'anello Indulock®;
- Sistema antistrappo garantito con boccola corta;
- Ottimizzazione delle scorte di magazzino.

Confronto tra SPFLEX ISOFLEX 6000 e 4SH

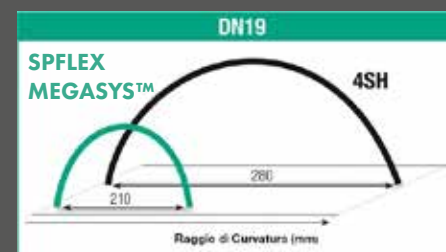

- SIGNIFICATAMENTE PIÙ FLESSIBILE
- RAGGI DI CURVATURA RIDOTTI PIÙ DEL 50%
- FINO A 10 VOLTE PIÙ RESISTENTE ALL'ABRASIONE



IMPIEGO

Tubo in gomma compatto singolo e binato, ideale per applicazioni dove è vantaggioso avere pressione associata alla linea di ritorno, quali sollevamento a forche, bracci telescopici, stabilizzatori ed avvolgitubi.

Raggi di curvatura estremamente ridotti (meno della metà di SAE 100 R2) e altissima flessibilità (ideale per applicazioni idrauliche con raggio di curvatura ridotto).

- Temperatura: -20°C +80°C (aria fino a +70°C)

STRUTTURA

- Sottostrato: nitrile (NBR).
- Rinforzi: **singola treccia d'acciaio ad alta resistenza**.
- Copertura: gomma sintetica nera liscia resistente all'abrasione, oli, ozono e agenti atmosferici.

APPLICATION

Rubber single and twin compact hose suitable for applications where it is advantageous to have pressure associated with the return line, such as lift trucks, telescopic arms, stabilizers and hose reels.

Small bending radii (less than half of SAE 100 R2) and high flexibility (ideal for hydraulic applications with reduced bending radii).

- Temperature range: -20°C +80°C (air up to +70°C)

CONSTRUCTION

- Tube: nitrile (NBR).
- Reinforcement: **one braid of high tensile steel wire**.
- Cover: weather and abrasion resistant smooth black synthetic rubber.

SINGOLO



Codice Part Number	Diametro Interno Inside Diameter			Ø Esterno O.D.	Pr. Esercizio Max WP	Pr. Scoppio Burst Pr.	Raggio Curv. Bend Radius	Peso Weight	Boccola Ferrule	Lunghezza Length
	DN	Inch	mm	mm	bar	bar	mm	Kg/mt		mt
100 137 140	6	1/4"	6,3	11,5	210	840	40	0,180	014 701 140	10-25-50
100 137 516	8	5/16"	7,9	13,6	210	840	40	0,210	014 701 516	10-25-50
100 137 380	10	3/8"	9,5	15,5	210	840	40	0,250	014 701 380	10-25-50

BINATO



Codice Part Number	Diametro Interno Inside Diameter			Ø Esterno O.D.	Pr. Esercizio Max WP	Pr. Scoppio Burst Pr.	Raggio Curv. Bend Radius	Peso Weight	Boccola Ferrule	Lunghezza Length
	DN	Inch	mm	mm	bar	bar	mm	Kg/mt		mt
100 337 140	6	1/4"	6,3	25,8	210	840	40	0,340	014 701 140	10-25-50
100 337 516	8	5/16"	7,9	13,6	210	840	40	0,400	014 701 516	10-25-50
100 337 380	10	3/8"	9,5	31,2	210	840	40	0,480	014 701 380	10-25-50

BINATO PASSO STRETTO



Codice Part Number	Diametro Interno Inside Diameter			Ø Esterno O.D.	Pr. Esercizio Max WP	Pr. Scoppio Burst Pr.	Raggio Curv. Bend Radius	Peso Weight	Boccola Ferrule	Lunghezza Length
	DN	Inch	mm	mm	bar	bar	mm	Kg/mt		mt
100 237 380	10	3/8"	9,5	30,0	250	1000	40	0,480	014 701 380	10-25-50

Linde Specifico per carrelli Linde / Specific for Linde Forklifts

⚠ Taglio a misura applicato sovrapprezzo di 15,00 euro / Cut to size applied supplement of 15,00 euro

TUBI COMPATTI
ELEVATOR

TUBI IN GOMMA COMPATTI
SINGOLI & BINATI
No Skive



- TUBI COMPATTI A LINEA SINGOLA E DOPPIA
- CONDOTTA INTERNA IN NITRILE CHE GARANTISCE MAGGIORE COMPATIBILITA' CON I FLUIDI
- RAGGI DI CURVATURA ESTREMAMENTE RIDOTTI E ALTA FLESSIBILITA'
- PRESSIONE D'ESERCIZIO COSTANTE.



IMPIEGO

TUBO ALTA PRESSIONE SP-COMPACTplus per Olii idraulici, minerali e "biologici", olii a base poliglicole, acqua, emulsioni olio/acqua.

Resistenza estrema all'acqua salmastra (idoneo per utilizzo nel settore nautico).

- Temperatura: -40°C +100°C con punte di 120°C

STRUTTURA

- Sottostrato: liscio in gomma nera sintetica a base di caucciù naturale oleoresistente.
- Rinforzi: **2 trecce acciaio alta resistenza.**
- Copertura: gomma sintetica a base di caucciù con ottima resistenza all'abrasione, ozono, raggi UV, olio, all'invecchiamento e all'acqua salmastra.
- Marcatura: **Indunorm[®] SPCOMPACTPLUS**

Fornibile a richiesta con rivestimenti in acciaio zincato o acciaio inox.

APPLICATION

HIGH PRESSURE SP-COMPACTplus HOSE for hydraulic mineral and „biological“ oils, polyglycol base oil, water, oil/water emulsions.

Extreme resistance to brackish water (suitable for use in the marine industry).

- Temperature range: -40°C +100°C peak of +120°C

CONSTRUCTION

- Tube: black, smooth, resistant synthetic rubber.
- Reinforcement: **2 high tensile steel wire braids.**
- Cover: abrasion, weather, ozone, oil resistant and brackish water synthetic black rubber.
- Branding: **Indunorm[®] SPCOMPACTPLUS**

Available on request with coverings: galvanized and stainless steel braids.



Code Part Number	Diametro Interno Inside Diameter			Ø Esterno O.D.	Pr. Esercizio Max WP	Pr. Scoppio Burst Pr.	Raggio Curv. Bend Radius	Boccola Indunorm	Boccola Ferrule	Lunghezza Lenght
	DN	Inch	mm	mm	bar	bar	mm			mt
SP-COMPACTPLUS 06	6	1/4"	6,3	14,2	450	1800	45	XVN04	014 120 140	20 - 40
SP-COMPACTPLUS 08	8	5/16"	8,0	16,0	420	1680	60	XVN05	014 120 516	20 - 40
SP-COMPACTPLUS 10	10	3/8"	9,5	18,3	385	1540	70	XVN06	014 120 380	20 - 40
SP-COMPACTPLUS 12	12	1/2"	12,7	21,5	345	1380	90	XVN08	014 120 120	20 - 40
SP-COMPACTPLUS 16	16	5/8"	16,0	24,7	290	1160	130	XVN10	014 120 580	20 - 40
SP-COMPACTPLUS 20	19	3/4"	19,0	28,6	280	1120	160	XVN12	014 120 340	20 - 40
SP-COMPACTPLUS 25	25	1"	25,4	36,6	210	840	210	XVN16	014 120 100	20 - 40

Altre lunghezze a richiesta / Other lenght on request



ECCEDE I VALORI DI PRESSIONE RISPETTO ALLE NORMATIVE EN 857 - 2SC

VANTAGGI:

- Raggi di curvatura ridotti rispetto al tubo 2SC standard;
- Eccede i valori di pressione della norma EN 857 2SC;
- Resistenza all'abrasione 10 volte superiore rispetto alla normativa EN ISO 9645;
- Elevata resistenza all'ozono ed all'acqua salmastra (ideale per l'utilizzo nel settore nautico in combinazione ai raccordi in acciaio inox);
- Raccordatura senza pelatura del tubo.

SETTORI DI UTILIZZO:

- Agricoltura, Forestale, Macchine per Giardinaggio;
- Edilizia, Macchine Stradali;
- Gru Navali,
- Applicazioni Industriali: posa entro catene portacavi e all'interno di tubazioni.

CARATTERISTICHE:

- Design molto compatto;
- Alta resistenza all'abrasione;
- Elevata resistenza all'acqua salata;
- Elevata resistenza all'ozono;
- Non necessita di pelatura;
- Utilizzo con i raccordi standard con possibilità di verifica con i tamponi di controllo del sistema di sicurezza.

Parametri di Abrasione secondo EN ISO 6945

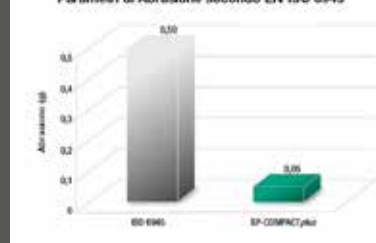

Confronto tra SP-COMPACTplus e 2SC

- PRESSIONI DI ESERCIZIO PIU' ELEVATE
- NOTEVOLE MIGLIORAMENTO DEI RAGGI DI CURVATURA
- PROPRIETA' ESTREMAMENTE ELEVATE ALL'ABRASIONE (10 VOLTE SUPERIORE ALLO STANDARD)



IMPIEGO

TUBO ALTA PRESSIONE SP2plus per Olii idraulici, minerali e "biologici", olii a base poliglicole, acqua, emulsioni olio/acqua.

- Temperatura: -40°C +100°C con punte di 120°C

STRUTTURA

- Sottostrato: liscio in gomma nera sintetica a base di caucciù naturale oleoresistente.
- Rinforzi: **2 treccce acciaio alta resistenza.**
- Copertura: gomma sintetica a base di caucciù con ottima resistenza all'abrasione, ozono, raggi UV, olio ed all'invecchiamento.
- Marcatura: **Indunorm[®] SP2PLUS**

Fornibile a richiesta con rivestimenti in acciaio zincato e acciaio inox.

APPLICATION

HIGH PRESSURE SP2plus HOSE for hydraulic mineral and „biological“ oils, polyglycol base oil, water, oil/water emulsions.

- Temperature range: -40°C +100°C peak of +120°C

CONSTRUCTION

- Tube: black, smooth, resistant synthetic rubber.
- Reinforcement: **2 high tensile steel wire braids.**
- Cover: abrasion, weather, ozone and oil resistant synthetic black rubber.
- Branding: **Indunorm[®] SP2PLUS**

Available on request with coverings: galvanized and stainless steel braids.



Codice Part Number	Diametro Interno Inside Diameter			Ø Esterno O.D.		Pr. Esercizio Max WP	Pr. Scoppio Burst Pr.	Raggio Curv. Bend Radius	Boccola Ferrule	Lunghezza Length
	DN	Inch	mm	mm	mm	bar	bar	mm		mt
SP2PLUS06	6	1/4"	6,3	14,2	450	1800	45	XV04C	20 - 40	
SP2PLUS08	8	5/16"	8,0	16,0	420	1680	60	XV05C	20 - 40	
SP2PLUS10	10	3/8"	9,5	18,3	385	1540	70	XV06C	20 - 40	
SP2PLUS12	12	1/2"	12,7	21,5	325	1300	90	XV08C	20 - 40	
SP2PLUS16	16	5/8"	16,0	24,7	290	1160	130	XV10C	20 - 40	

Altre lunghezze a richiesta/ Other length on request



MAGGIORI PERFORMANCE DI PRESSIONE RISPETTO AL 2SN



VANTAGGI:

- Raggio di curvatura ridotto del 30% rispetto al tubo 2SN standard;
- Eccede i valori di pressione della norma EN 853 2SN;
- Resistenza all'abrasione 10 volte superiore rispetto alla normativa EN ISO 9645;
- Alto carico agli impulsi di pressione;
- Rinforzo 2 treccce d'acciaio ad alta pressione che permettono di coprire molteplici applicazioni.

SETTORI DI UTILIZZO:

- Gru Telescopiche;
- Sponde Idrauliche;
- Mezzi Spartineve;
- Veicoli d'uso Urbano;
- Costruzioni / sistemi idraulici mobili.

CARATTERISTICHE:

- Alto margine di pressione;
- Alto carico agli impulsi di pressione;
- Alta resistenza all'abrasione;
- Massima sicurezza con il sistema a pe-lare;
- Utilizzo con i raccordi standard con possibilità di verifica con i tamponi di controllo del sistema di sicurezza.

Confronto tra SP2plus e 2SN



- FINO AL 30% PIÙ STRETTO DELLO STANDARD RAGGIO DI CURVATURA
- FINO A 10 VOLTE PIÙ RESISTENTE ALL'ABRASIONE
- FINO AL 20% PIÙ RESISTENTE ALLA COMPRESSIONE
- ALTO MARGINE DI PRESSIONE



IMPIEGO

TUBO ALTA PRESSIONE SP4plus per Olii idraulici, minerali e "biologici", olii a base poliglicole, acqua, emulsioni olio/acqua.

- Temperatura: -40°C +100°C con punte di 120°C

STRUTTURA

- Sottostrato: liscio in gomma nera sintetica a base di caucciù naturale oleoresistente.
- Rinforzi: **3 treccce acciaio alta resistenza.**
- Copertura: gomma sintetica a base di caucciù con ottima resistenza all'abrasione, ozono, raggi UV, olio ed all'invecchiamento.
- Marcatura: **Indunorm® SP4PLUS**

Fornibile a richiesta con rivestimenti in acciaio zincato e acciaio inox.

APPLICATION

HIGH PRESSURE SP4plus HOSE for hydraulic mineral and „biological“ oils, polyglycol base oil, water, oil/water emulsions.

- Temperature range: -40°C +100°C peak of +120°C

CONSTRUCTION

- Tube: black, smooth, resistant synthetic rubber.
- Reinforcement: **3 high tensile steel wire braids.**
- Cover: abrasion, weather, ozone and oil resistant synthetic black rubber.
- Branding: **Indunorm® SP4PLUS**

Available on request with coverings: galvanized and stainless steel braids.



ECCEDE I VALORI DI PRESSIONE RISPETTO ALLE NORMATIVE EN 856 - 4SP

VANTAGGI:

- Raggio di curvatura ridotto fino al 30% rispetto al tubo 4SP standard;
- Eccede i valori di pressione della norma EN 856 4SP;
- Elevata resistenza all'abrasione;
- Alta resistenza anti strozzature;
- Rinforzo 3 treccce d'acciaio che gli permette di avere una straordinaria flessibilità di installazione.

SETTORI DI UTILIZZO:

- Macchine Forestali atte per il disboscamento;
- Ragni per il recupero dei rottami;
- Ingegneria Civile;
- Industria in generale;
- Costruzioni / sistemi idraulici mob

CARATTERISTICHE:

- Elevati carichi ad alta pressione;
- riduzione dei raggi di curvatura;
- Ottima resistenza all'abrasione ed all'ozono;
- Straordinaria flessibilità in piccoli spazi;
- Massima sicurezza con il sistema a pelare;
- Utilizzo con i raccordi standard con possibilità di verifica con i tamponi di controllo del sistema di sicurezza.



Codice Part Number	Diametro Interno Inside Diameter		Ø Esterno O.D.	Pr. Esercizio Max WP	Pr. Scoppio Burst Pr.	Raggio Curv. Bend Radius	Boccola Indunorm	Boccola Ferrule	Lunghezza Length
	DN	Inch							
SP4PLUS10	10	3/8"	9,5	21,2	500	2000	120	XV06D/4L 014 802 380	20 - 40
SP4PLUS12	12	1/2"	12,7	24,6	470	1880	160	XV08D/4L 014 8021 20	20 - 40
SP4PLUS16	16	5/8"	16,0	28,0	410	1640	210	XV10D/4L 014 802 580	20 - 40
SP4PLUS20	19	3/4"	19,0	32,2	375	1500	260	XV12D/4L 014 802 340	20 - 40
SP4PLUS25	25	1"	25,4	39,4	310	1240	310	XV16D/4L 014 802 100	20 - 40

Altre lunghezze a richiesta/ Other length on request



Confronto tra SP4plus e SP4

- MIGLIORAMENTO SIGNIFICATIVO DELLA QUALITA'
- FINO AL 30% DI RIDUZIONE DEI RAGGI DI CURVATURA
- NOTEVOLE RESISTENZA ALL'OZONO



TUBI GOMMA ALTA PRESSIONE
HIGH PRESSURE RUBBER HOSES

TUBI GOMMA ALTA TEMPERATURA
HIGH TEMPERATURE RUBBER HOSES

IDROWASH 1SC

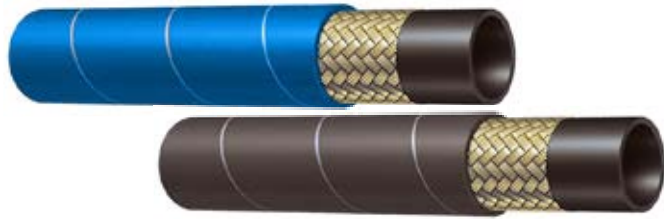

IMPIEGO

TUBO ALTA PRESSIONE 1SC per passaggio acqua e detersivi in soluzione acquosa.

- Temperatura: -40°C +150°C

STRUTTURA

- Sottostrato: liscio in gomma nera sintetica resistente all'acqua e detersivi in soluzione acquosa.
- Rinforzi: **1 treccia acciaio alta resistenza.**
- Copertura: gomma sintetica **microforata BLU / NERO ANTIMACCHIA** con ottima resistenza all'abrasione, ozono, olio ed all'invecchiamento.
- Normative: EN 853 – 1SC
- Specifica di riferimento: IEC – 60335 -2

APPLICATION

HIGH PRESSURE 1SC HOSE for water and detergent aqueous emulsions conduction.

- Temperature range: -40°C +150°C

CONSTRUCTION

- Tube: black, smooth, water and detergent aqueous emulsions resistant synthetic rubber.
- Reinforcement: **1 high tensile steel wire braid.**
- Cover: abrasion, weather, ozone and oil resistant synthetic **pin-pricked BLUE / BLACK rubber.**
- According to: EN 853 – 1SC
- Reference specification: IEC – 60335 -2



Codice Part Number	Diametro Interno Inside Diameter			Ø Esterno O.D.	Pr. Esercizio Max WP	Pr. Scoppio Burst Pr.	Raggio Curv. Bend Radius	Peso Weight	Boccola Ferrule	Lunghezza Length
	DN	Inch	mm							
BLU / BLUE										
100 401 140	6	1/4"	6,4	12,4	210	840	75	0,184	014 100 140	50 - 100
100 401 516	8	5/16"	7,9	14,1	230	860	85	0,216	014 100 516	50 - 100
• 100 401 380	10	3/8"	9,5	16,1	210	720	90	0,281	014 100 380	> 50
• 100 401 120	12	1/2"	12,8	19,3	160	640	95	0,360	014 100 120	> 50
NERO / BLACK										
100 501 140	6	1/4"	6,4	12,4	210	840	75	0,184	014 100 140	50 - 100
100 501 516	8	5/16"	7,9	14,1	230	860	85	0,216	014 100 516	50 - 100
• 100 501 380	10	3/8"	9,5	16,1	210	720	90	0,281	014 100 380	> 50
• 100 501 120	12	1/2"	12,8	19,3	160	640	95	0,360	014 100 120	> 50

IDROWASH 2SC

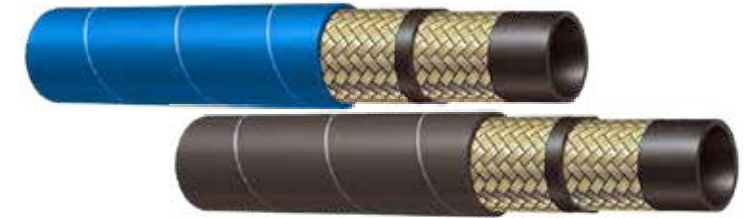

IMPIEGO

TUBO ALTA PRESSIONE 2SC per passaggio acqua e detersivi in soluzione acquosa.

- Temperatura: -40°C +150°C

STRUTTURA

- Sottostrato: liscio in gomma nera sintetica resistente all'acqua e detersivi in soluzione acquosa.
- Rinforzi: **2 treccia acciaio alta resistenza.**
- Copertura: gomma sintetica **microforata BLU / NERO ANTIMACCHIA** con ottima resistenza all'abrasione, ozono, olio ed all'invecchiamento.
- Normative: EN 853 – 2SC
- Specifica di riferimento: IEC – 60335 -2

APPLICATION

HIGH PRESSURE 2SC HOSE for water and detergent aqueous emulsions conduction.

- Temperature range: -40°C +150°C

CONSTRUCTION

- Tube: black, smooth, water and detergent aqueous emulsions resistant synthetic rubber.
- Reinforcement: **2 high tensile steel wire braid.**
- Cover: abrasion, weather, ozone and oil resistant synthetic **pin-pricked BLUE / BLACK rubber.**
- According to: EN 853 – 2SC
- Reference specification: IEC – 60335 -2



Codice Part Number	Diametro Interno Inside Diameter			Ø Esterno O.D.	Pr. Esercizio Max WP	Pr. Scoppio Burst Pr.	Raggio Curv. Bend Radius	Peso Weight	Boccola Ferrule	Lunghezza Length
	DN	Inch	mm							
BLU / BLUE										
100 402 140	6	1/4"	6,4	13,2	400	1600	75	0,302	014 120 140	50 - 100
100 402 516	8	5/16"	7,9	14,5	400	1400	85	0,362	014 120 516	50 - 100
100 402 380	10	3/8"	9,5	17,0	400	1320	90	0,452	014 120 380	50 - 100
100 402 120	12	1/2"	12,8	20,8	300	1200	95	0,540	014 120 120	25 - 50
NERO / BLACK										
100 502 140	6	1/4"	6,4	13,2	400	1600	75	0,302	014 120 140	50 - 100
100 502 516	8	5/16"	7,9	14,5	400	1400	85	0,362	014 120 516	50 - 100
100 502 380	10	3/8"	9,5	17,0	400	1320	90	0,452	014 120 380	50 - 100
100 502 120	12	1/2"	12,8	20,8	300	1200	95	0,540	014 120 120	25 - 50



IMPIEGO

Tubo con 1 rinforzo in acciaio trecciato per linee di pressione medio-bassa in condizioni di alta temperatura. Idoneo per aria, olii idraulici, minerali e "biologici", olii a base poliglicole, acqua, emulsioni olio/acqua.

- Temperatura: -40°C +135°C con punte di **+150°C**

STRUTTURA

- Sottostrato: liscio in gomma nera sintetica oleoresistente
- Rinforzi: **1 treccia acciaio alta resistenza.**
- Copertura: gomma sintetica **BLU** con ottima resistenza al **CALORE**, abrasione, ozono, olio ed all'invecchiamento.
- Normative: EN853 – 1SN – SAE 100 RIAT

APPLICATION

1 wire braided reinforced hose for low-medium pressure lines in high temperature conditions.

Suitable for air, hydraulic mineral and „biological“ oils, polyglycol base oil, water, oil/water emulsions.

- Temperature range: -40°C +135°C peak of **+150°C**

CONSTRUCTION

- Tube: black, smooth, resistant synthetic rubber.
- Reinforcement: **1 high tensile steel wire braid.**
- Cover: **HEAT**, abrasion, weather, ozone and oil resistant synthetic **BLUE** rubber.
- According to: EN853 – 1SN – SAE 100 RIAT



Codice Part Number	Diametro Interno Inside Diameter			Ø Esterno O.D.	Pr. Esercizio Max WP	Pr. Scoppio Burst Pr.	Raggio Curv. Bend Radius	Peso Weight	Boccola Ferrule	Lunghezza Length
	DN	Inch	mm							
• 100 301 316	5	3/16"	4,8	11,9	250	1000	90	0,180	014 120 316	> 10
• 100 301 140	6	1/4"	6,4	13,5	225	900	100	0,230	014 120 140	> 10
• 100 301 516	8	5/16"	7,9	15,1	215	860	115	0,280	014 120 516	> 10
• 100 301 380	10	3/8"	9,5	17,5	180	720	130	0,360	014 120 380	> 10
• 100 301 120	12	1/2"	12,8	20,6	160	640	180	0,430	014 120 120	> 10
• 100 301 580	16	5/8"	16,0	23,8	130	520	200	0,510	014 120 580	> 10
• 100 301 340	19	3/4"	19,0	27,9	105	420	240	0,620	014 120 340	> 10
• 100 301 100	25	1"	25,4	36,0	88	352	300	0,935	014 120 100	> 10
• 100 301 114	31	1.1/4"	31,8	43,4	63	252	420	1,300	014 120 114	> 10
• 100 301 112	38	1.1/2"	38,1	50,1	50	200	500	1,550	014 120 112	> 10
• 100 301 200	50	2"	50,8	63,5	40	160	630	2,300	014 120 200	> 10

• Fornibile in 7 gg lavorativi / Available in 7 working days



IMPIEGO

Tubo con 2 rinforzi in acciaio trecciato per linee di pressione medio-bassa in condizioni di alta temperatura. Idoneo per aria, olii idraulici, minerali e "biologici", olii a base poliglicole, acqua, emulsioni olio/acqua.

- Temperatura: -40°C +135°C con punte di **+150°C**

STRUTTURA

- Sottostrato: liscio in gomma nera sintetica oleoresistente
- Rinforzi: **2 treccia acciaio alta resistenza.**
- Copertura: gomma sintetica **BLU** con ottima resistenza al **CALORE**, abrasione, ozono, olio ed all'invecchiamento.
- Normative: EN853 – 2SN – SAE 100 R2AT

APPLICATION

2 wire braided reinforced hose for low-medium pressure lines in high temperature conditions.

Suitable for air, hydraulic mineral and „biological“ oils, polyglycol base oil, water, oil/water emulsions.

- Temperature range: -40°C +135°C peak of **+150°C**

CONSTRUCTION

- Tube: black, smooth, resistant synthetic rubber.
- Reinforcement: **2 high tensile steel wire braid.**
- Cover: **HEAT**, abrasion, weather, ozone and oil resistant synthetic **BLUE** rubber.
- According to: EN853 – 2SN – SAE 100 R2AT



Codice Part Number	Diametro Interno Inside Diameter			Ø Esterno O.D.	Pr. Esercizio Max WP	Pr. Scoppio Burst Pr.	Raggio Curv. Bend Radius	Peso Weight	Boccola Ferrule	Lunghezza Length
	DN	Inch	mm							
• 100 302 316	5	3/16"	4,8	13,3	415	1660	90	0,280	014 120 316	> 10
• 100 302 140	6	1/4"	6,4	14,8	400	1600	100	0,355	014 120 140	> 10
• 100 302 516	8	5/16"	7,9	16,5	350	1400	115	0,420	014 120 516	> 10
• 100 302 380	10	3/8"	9,5	18,9	330	1320	130	0,530	014 120 380	> 10
• 100 302 120	12	1/2"	12,8	22,0	275	1100	180	0,630	014 120 120	> 10
• 100 302 580	16	5/8"	16,0	25,2	250	1000	200	0,735	014 120 580	> 10
• 100 302 340	19	3/4"	19,0	29,2	215	860	240	0,955	014 120 340	> 10
• 100 302 100	25	1"	25,4	37,1	165	660	300	1,340	014 120 100	> 10
• 100 302 114	31	1.1/4"	31,8	47,0	125	500	420	1,900	014 120 114	> 10
• 100 302 112	38	1.1/2"	38,1	53,5	90	360	500	2,225	014 120 112	> 10
• 100 302 200	50	2"	50,8	66,2	80	320	630	3,200	014 120 200	> 10

• Fornibile in 7 gg lavorativi / Available in 7 working days



TUBI GOMMA ALTA PRESSIONE
HIGH PRESSURE RUBBER HOSES

TUBI TERMOPLASTICI
THERMOPLASTIC HOSES



IMPIEGO

Tubo conforme o superiore ai requisiti SAE 100R7 per medie pressioni per applicazioni oleodinamiche con ottima resistenza all'abrasione. Idoneo per fluidi idraulici a base minerale, sintetica o acquosa in sistemi oleodinamici. Adatto a trasmissione idraulica della potenza in macchine agricole e movimento terra e carrelli elevatori. Adatto anche per molti gas industriali (verificare compatibilità). **Approvato da MSHA - Mine Safety and Health Administration - numero IC-305.**

- Temperatura: - 40 °C +100 °C, limitata a +70 °C per aria e fluidi a base acquosa

STRUTTURA

- Sottostrato: elastomero poliestere.
- Rinforzi: **1 o 2 trecce in fibra sintetica.**
- Copertura: poliuretano, nero, microforatura, marcatura ink-jet bianca.
- Normative: SAE 100R7 // EN855-R7 // ISO3949-R7

APPLICATION

Meets or exceeds SAE 100R7 medium pressure hose suitable for hydraulic applications with increased resistance to abrasion. Suitable for use with petroleum, synthetic or water based hydraulic fluids in hydraulic systems. Suitable for general fluid power transmissions like earthmoving, agricultural machinery and forklifts trucks. Also suitable for many industrial gases (check for compatibility). **MSHA - Mine Safety and Health Administration - numero IC-305 approved.**

- Temperature range: -40°C to +100°C, limited to +70°C for air and water based fluids.

CONSTRUCTION

- Tube: polyester elastomer.
- Reinforcement: **1 or 2 braids of synthetic fiber.**
- Cover: polyurethane, black, pinpricked, white ink-jet branding.
- According to: SAE 100R7 // EN855-R7 // ISO3949-R7



Codice Part Number	Diametro Interno Inside Diameter			Ø Esterno O.D.	Pr. Esercizio Max WP	Pr. Scoppio Burst Pr.	Raggio Curv. Bend Radius	Peso Weight	Boccola Ferrule	Lunghezza Lenght
	DN	Inch	mm							
100 007 180	3	1/8"	4	8,5	230	920	25	0,055	014 700 180	25-50-100
▲ 100 007 532	4	5/32"	4	8,0	200	800	30	0,045	014 700 532	25-50-100
100 007 316	5	3/16"	5	9,6	210	840	25	0,060	014 701 316	25-50-100
100 007 140	6	1/4"	6,5	12,2	210	840	35	0,100	014 701 140	25-50-100
100 007 516	8	5/16"	8,1	14,3	190	760	45	0,130	014 701 516	25-50-100
100 007 380	10	3/8"	9,7	16	160	640	55	0,145	014 701 380	25-50-100
100 007 120	12	1/2"	13	20,3	140	560	75	0,220	014 701 120	10-25-50
TP-R7-16	16	5/8"	16,3	23,7	105	420	110	0,280	014 701 580	> 1
TP-R7-20	19	3/4"	19,5	27,1	90	360	140	0,335	014 701 340	> 1
TP-R7-25	25	1"	25,9	34	70	280	190	0,455	014 701 100	> 1

▲ Progettato appositamente per varie applicazioni di ingrassaggio e lubrificazione.
Specifically designed for diverse greasing and lubrication applications.



IMPIEGO

Tubo conforme o superiore ai requisiti SAE 100R7 per medie pressioni per applicazioni oleodinamiche con ottima resistenza all'abrasione. Idoneo per fluidi idraulici a base minerale, sintetica o acquosa in sistemi oleodinamici. Adatto a trasmissione idraulica della potenza in macchine agricole e movimento terra e carrelli elevatori. Adatto anche per molti gas industriali (verificare compatibilità). **Approvato da MSHA - Mine Safety and Health Administration - numero IC-305.**

- Temperatura: - 40 °C +100 °C, limitata a +70 °C per aria e fluidi a base acquosa

STRUTTURA

- Sottostrato: elastomero poliestere.
- Rinforzi: **1 o 2 trecce in fibra sintetica.**
- Copertura: poliuretano, nero, microforatura, marcatura ink-jet bianca.
- Normative: SAE 100R7 // EN855-R7 // ISO3949-R7

APPLICATION

Meets or exceeds SAE 100R7 medium pressure hose suitable for hydraulic applications with increased resistance to abrasion. Suitable for use with petroleum, synthetic or water based hydraulic fluids in hydraulic systems. Suitable for general fluid power transmissions like earthmoving, agricultural machinery and forklifts trucks. Also suitable for many industrial gases (check for compatibility). **MSHA - Mine Safety and Health Administration - numero IC-305 approved.**

- Temperature range: -40°C to +100°C, limited to +70°C for air and water based fluids.

CONSTRUCTION

- Tube: polyester elastomer.
- Reinforcement: **1 or 2 braids of synthetic fiber.**
- Cover: polyurethane, black, pinpricked, white ink-jet branding.
- According to: SAE 100R7 // EN855-R7 // ISO3949-R7



Codice Part Number	Diametro Interno Inside Diameter			Ø Esterno O.D.	Pr. Esercizio Max WP	Pr. Scoppio Burst Pr.	Raggio Curv. Bend Radius	Peso Weight	Boccola Ferrule	Lunghezza Lenght
	DN	Inch	mm							
100 207 316	5	3/16"	5	9,6	210	840	25	0,120	014 701 316	10-25-50
100 207 140	6	1/4"	6,5	12,2	210	840	35	0,200	014 701 140	10-25-50
100 207 516	8	5/16"	8,1	14,3	190	760	45	0,260	014 701 516	10-25-50
100 207 380	10	3/8"	9,7	16	160	640	55	0,290	014 701 380	10-25-50
100 207 120	12	1/2"	13	20,3	140	560	75	0,440	014 701 120	10-25-50

250 bar

250 bar



IMPIEGO

Tubo per medie pressioni per fluidi a base di petrolio o sintetici in sistemi oleodinamici o in carrelli elevatori. L'eccellente adesione e le ottime caratteristiche meccaniche della copertura lo rendono il **tubo ideale per macchinari che operano a basse temperature mantenendo un elevato livello di flessibilità.**

Doppia treccia in poliestere dalla dimensione 1/4"-DN6 in poi; stretto raggio di curvatura senza increspature della copertura.

- Temperatura: **-55 °C +100 °C**, limitata a +70 °C per aria e fluidi a base acquosa

STRUTTURA

- Sottostrato: elastomero poliestere.
- Rinforzi: **2 trecce in fibra sintetica.**
- Copertura: speciale poliestere resistente a basse temperature e a dure condizioni meteorologiche, nero, microforatura, marcatura ink-jet bianca.
- Normative: Superiore a SAE 100R18 // ISO3949-R18

APPLICATION

Medium pressure hose suitable for petroleum or synthetic based hydraulic fluids in hydraulic systems of forklifts. Optimum bonding characteristics and special cover also make it the **ideal hose for equipment operating in cold environments while maintaining a high level of flexibility.**

2 polyester braid construction from 1/4-DN6 onwards; tight bend radii without cover wrinkling.

- Temperature range: **-55°C to +100°C**, limited to +70°C for air and water based fluids.

CONSTRUCTION

- Tube: polyester elastomer.
- Reinforcement: **2 braids of synthetic fiber.**
- Cover: special polyester cover resistant to low temperatures and meteorological harsh conditions, black, pinpricked, white ink-jet branding.
- According to: Exceeds SAE 100R18 // ISO3949-R18



Codice Part Number	Diametro Interno Inside Diameter			Ø Esterno O.D.	Pr. Esercizio Max WP	Pr. Scoppio Burst Pr.	Raggio Curv. Bend Radius	Peso Weight	Boccola Ferrule	Lunghezza Length
	DN	Inch	mm							
TP27-06	6	1/4"	6,5	13	250	1000	35	0,115	014 701 140	> 1
TP27-08	8	5/16"	8,1	15	250	1000	45	0,145	014 701 516	> 1
TP27-10	10	3/8"	9,7	18	250	1000	55	0,205	014 701 380	> 1

BINATO



Codice Part Number	Diametro Interno Inside Diameter			Ø Esterno O.D.	Pr. Esercizio Max WP	Pr. Scoppio Burst Pr.	Raggio Curv. Bend Radius	Peso Weight	Boccola Ferrule	Lunghezza Length
	DN	Inch	mm							
100 267 140	6	1/4"	6,5	12,7	250	1000	40	0,107	014 701 140	25 - 50 - 100
100 267 516	8	5/16"	8,1	15,0	250	1000	50	0,250	014 701 516	25 - 50 - 100
100 267 380	10	3/8"	9,7	18,0	250	1000	50	0,205	014 701 380	25 - 50 - 100

Linde Specifico per carrelli Linde / Specific for Linde Forklifts

NEW



IMPIEGO

Tubo conforme o superiore ai requisiti SAE 100R7 per medie pressioni idoneo per fluidi idraulici a base minerale, sintetica o acquosa in sistemi oleodinamici che richiedono elevata resistenza all'acqua di mare e ad ambiente salino. **La copertura bianca con protezione UV lo rende la scelta ideale per attrezzature di yacht e imbarcazioni da diporto.**

Leggero, flessibile, compatto, eccellente adesione fra gli strati, resistente all'abrasione.

- Temperatura: -40 °C +100 °C, limitata a +70 °C per aria e fluidi a base acquosa

STRUTTURA

- Sottostrato: elastomero poliestere.
- Rinforzi: **1 o 2 trecce in fibra sintetica.**
- Copertura: poliuretano, **bianco**, microforatura, marcatura ink-jet nera.
- Normative: SAE 100R7 // EN855-R7 // ISO3949-R7

APPLICATION

Meets or exceeds SAE100R7 - Medium pressure hose suitable for petroleum synthetic or water based hydraulic fluids used in applications requiring increased resistance to seawater and saline environment. **The white cover with UV protection makes it the ideal choice for pleasure boats and yachting equipment.**

Lightweight, flexible, compact, bonded construction, abrasion resistant.

- Temperature range: -40°C to +100°C, limited to +70°C for air and water based fluids.

CONSTRUCTION

- Tube: polyester elastomer.
- Reinforcement: **1 or 2 braids of synthetic fiber.**
- Cover: polyurethane, **white**, pinpricked, black ink-jet branding.
- According to: ISAE 100R7 // EN855-R7 // ISO3949-R7



Codice Part Number	Diametro Interno Inside Diameter			Ø Esterno O.D.	Pr. Esercizio Max WP	Pr. Scoppio Burst Pr.	Raggio Curv. Bend Radius	Peso Weight	Boccola Ferrule	Lunghezza Length
	DN	Inch	mm							
• X00 007 316	5	3/16"	5	9,6	210	840	25	0,120	X14 700 316	25 - 50
• X00 007 140	6	1/4"	6,5	12,2	210	840	35	0,200	X14 700 140	a richiesta
• X00 007 516	8	5/16"	8,1	14,3	190	760	45	0,260	X14 700 516	a richiesta
• X00 007 380	10	3/8"	9,7	16	160	640	55	0,290	X14 700 380	a richiesta
• X00 007 120	12	1/2"	13	20,3	140	560	75	0,440	X14 700 120	a richiesta

Microforato



IMPIEGO

Tubo conforme o superiore ai requisiti SAE 100R8 per alta pressione adatto ad applicazioni oleodinamiche con elevata resistenza all'abrasione ed espansione volumetrica estremamente limitata. Indicato per fluidi idraulici a base minerale, sintetica o acquosa in sistemi oleodinamici. Adatto alla trasmissione idraulica della potenza in macchine movimento terra e agricole, sollevatori ed altre macchine ad alta pressione. Idoneo anche per molti gas industriali (verificare compatibilità). **Approvato da MSHA - Mine Safety and Health Administration - numero IC-305.**

- Temperatura: - 40 °C +100 °C, limitata a +70 °C per aria e fluidi a base acquosa

STRUTTURA

- Sottostrato: elastomero poliестere.
- Rinforzi: **1 o 2 trecce in fibra aramidica.**
- Copertura: poliuretano, nero, microforatura, marcatura ink-jet bianca.
- Normative: SAE 100R8 // EN855-R8 // ISO3949-R8

APPLICATION

Meets or exceeds SAE 100R7 medium pressure hose suitable for hydraulic applications with increased resistance to abrasion. Suitable for use with petroleum, synthetic or water based hydraulic fluids in hydraulic systems. Suitable for general fluid power transmissions like earthmoving, agricultural machinery and forklifts trucks. Also suitable for many industrial gases (check for compatibility). **MSHA - Mine Safety and Health Administration - numero IC-305 approved.**

- Temperature range: -40°C to +100°C, limited to +70°C for air and water based fluids.

CONSTRUCTION

- Tube: polyester elastomer.
- Reinforcement: **1 or 2 braids of aramid fiber.**
- Cover: polyurethane, black, pinpricked, white ink-jet branding.
- According to: SAE 100R8 // EN855-R8 // ISO3949-R8



Codice Part Number	Diametro Interno Inside Diameter			Ø Esterno O.D.	Pr. Esercizio Max WP	Pr. Scoppio Burst Pr.	Raggio Curv. Bend Radius	Peso Weight	Boccola Ferrule	Lunghezza Lenght
	DN	Inch	mm							
100 047 316	5	3/16"	5,0	8,9	350	1400	30	0,050	014 701 316	50-100
100 047 140	6	1/4"	6,5	11,5	350	1400	50	0,085	014 701 140	50-100
100 047 516	8	5/16"	8,1	13,4	300	1200	55	0,105	014 701 516	50-100
100 047 380	10	3/8"	9,7	15,5	280	1120	60	0,135	014 701 380	50-100
100 047 120	12	1/2"	13,0	19,9	245	980	80	0,208	014 701 120	50-100



IMPIEGO

Tubo conforme o superiore ai requisiti SAE 100R8 per alta pressione adatto ad applicazioni oleodinamiche con elevata resistenza all'abrasione ed espansione volumetrica estremamente limitata. Indicato per fluidi idraulici a base minerale, sintetica o acquosa in sistemi oleodinamici. Adatto alla trasmissione idraulica della potenza in macchine movimento terra e agricole, sollevatori ed altre macchine ad alta pressione. Idoneo anche per molti gas industriali (verificare compatibilità). **Approvato da MSHA - Mine Safety and Health Administration - numero IC-305.**

- Temperatura: - 40 °C +100 °C, limitata a +70 °C per aria e fluidi a base acquosa

STRUTTURA

- Sottostrato: elastomero poliестere.
- Rinforzi: **1 o 2 trecce in fibra aramidica.**
- Copertura: poliuretano, nero, microforatura, marcatura ink-jet bianca.
- Normative: SAE 100R8 // EN855-R8 // ISO3949-R8

APPLICATION

Meets or exceeds SAE 100R7 medium pressure hose suitable for hydraulic applications with increased resistance to abrasion. Suitable for use with petroleum, synthetic or water based hydraulic fluids in hydraulic systems. Suitable for general fluid power transmissions like earthmoving, agricultural machinery and forklifts trucks. Also suitable for many industrial gases (check for compatibility). **MSHA - Mine Safety and Health Administration - numero IC-305 approved.**

- Temperature range: -40°C to +100°C, limited to +70°C for air and water based fluids.

CONSTRUCTION

- Tube: polyester elastomer.
- Reinforcement: **1 or 2 braids of aramid fiber.**
- Cover: polyurethane, black, pinpricked, white ink-jet branding.
- According to: SAE 100R8 // EN855-R8 // ISO3949-R8



Codice Part Number	Diametro Interno Inside Diameter			Ø Esterno O.D.	Pr. Esercizio Max WP	Pr. Scoppio Burst Pr.	Raggio Curv. Bend Radius	Peso Weight	Boccola Ferrule	Lunghezza Lenght
	DN	Inch	mm							
TP-R8-Z06	6	1/4"	6,5	11,5	350	1400	50	0,170	014 701 140	> 1
TP-R8-Z08	8	5/16"	8,1	13,4	300	1200	55	0,210	014 701 516	> 1
TP-R8-Z10	10	3/8"	9,7	15,5	280	1120	60	0,270	014 701 380	> 1
TP-R8-Z12	12	1/2"	13,0	19,9	245	980	80	0,400	014 701 120	> 1



IMPIEGO

Tubo conforme o superiore alle specifiche di pressione delle norme UNI EN 853 1SN e EN 857 1SC. Idoneo per fluidi a base di petrolio, sintetici e acquosi in sistemi oleodinamici. Adatto alla trasmissione idraulica di potenza in macchine movimento terra e agricole, carrelli elevatori ed attrezzature ad alta pressione. La **treccia in acciaio** offre maggior protezione meccanica rispetto ai tubi con treccia in fibra poliestere. **Approvato da MSHA - Mine Safety and Health Administration - numero IC-305.**

- Temperatura: - 40 °C +100 °C, limitata a +70 °C per aria e fluidi a base acquosa

STRUTTURA

- Sottostrato: elastomero poliestere.
- Rinforzi: **1 treccia in acciaio.**
- Copertura: poliuretano, nero, non microforato, marcatura ink-jet bianca.
- Normative: SAE 100R1. Conforme o superiore alle specifiche di pressione di EN 853 1SN e EN 857 1SC

APPLICATION

Meets or exceeds pressure specifications of UNI EN 853 1SN and EN 857 1SC. Suitable for petroleum synthetic or water based hydraulic fluids in hydraulic systems. Suitable for general fluid power transmissions like earthmoving - agricultural machinery - forklifts trucks and other high pressure equipment. **Steel braid** offers increased mechanical protection compared to yarn braided hoses. **MSHA - Mine Safety and Health Administration - numero IC-305 approved.**

- Temperature range: -40°C to +100°C, limited to +70°C for air and water based fluids.

CONSTRUCTION

- Tube: polyester elastomer.
- Reinforcement: **1 braid of steel wire.**
- Cover: polyurethane, black, non pinpricked, white ink-jet branding.
- According to: SAE 100R1. Meets or exceeds pressure specification of EN 853 1SN and EN 857 1SC



Codice Part Number	Diametro Interno Inside Diameter			Ø Esterno O.D.	Pr. Esercizio Max WP	Pr. Scoppio Burst Pr.	Raggio Curv. Bend Radius	Peso Weight	Boccola Ferrule	Lunghezza Lenght
	DN	Inch	mm							
100 017 316	5	3/16"	5	9,7	360	1440	30	0,125	014 701 316	25-50-100
100 017 140	6	1/4"	6,5	11,7	310	1240	40	0,165	014 701 140	25-50-100
100 017 516	8	5/16"	8,1	13,2	250	1000	55	0,190	014 701 516	25-50-100
100 017 380	10	3/8"	9,8	15,5	225	900	65	0,230	014 701 380	25-50-100
100 017 120	12	1/2"	13	18,8	190	760	85	0,300	014 701 120	10-25-50
TP1-16	16	5/8"	16,3	22	140	560	115	0,335	014 701 580	> 1
TP1-20	19	3/4"	19,5	25,8	115	460	145	0,460	014 701 340	> 1
TP1-25	25	1"	25,8	33,4	95	380	180	0,640	014 701 100	> 1



IMPIEGO

Tubo conforme o superiore alle specifiche di pressione delle norme UNI EN 853 1SN e EN 857 1SC. Idoneo per fluidi a base di petrolio, sintetici e acquosi in sistemi oleodinamici. Adatto alla trasmissione idraulica di potenza in macchine movimento terra e agricole, carrelli elevatori ed attrezzature ad alta pressione. La **treccia in acciaio** offre maggior protezione meccanica rispetto ai tubi con treccia in fibra poliestere. **Approvato da MSHA - Mine Safety and Health Administration - numero IC-305.**

- Temperatura: - 40 °C +100 °C, limitata a +70 °C per aria e fluidi a base acquosa

STRUTTURA

- Sottostrato: elastomero poliestere.
- Rinforzi: **1 treccia in acciaio.**
- Copertura: poliuretano, nero, non microforato, marcatura ink-jet bianca.
- Normative: SAE 100R1. Conforme o superiore alle specifiche di pressione di EN 853 1SN e EN 857 1SC

APPLICATION

Meets or exceeds pressure specifications of UNI EN 853 1SN and EN 857 1SC. Suitable for petroleum synthetic or water based hydraulic fluids in hydraulic systems. Suitable for general fluid power transmissions like earthmoving - agricultural machinery - forklifts trucks and other high pressure equipment. **Steel braid** offers increased mechanical protection compared to yarn braided hoses. **MSHA - Mine Safety and Health Administration - numero IC-305 approved.**

- Temperature range: -40°C to +100°C, limited to +70°C for air and water based fluids.

CONSTRUCTION

- Tube: polyester elastomer.
- Reinforcement: **1 braid of steel wire.**
- Cover: polyurethane, black, non pinpricked, white ink-jet branding.
- According to: SAE 100R1. Meets or exceeds pressure specification of EN 853 1SN and EN 857 1SC



Codice Part Number	Diametro Interno Inside Diameter			Ø Esterno O.D.	Pr. Esercizio Max WP	Pr. Scoppio Burst Pr.	Raggio Curv. Bend Radius	Peso Weight	Boccola Ferrule	Lunghezza Lenght
	DN	Inch	mm							
100 217 316	5	3/16"	5	9,7	360	1440	30	0,250	014 701 316	10-25-50
100 217 140	6	1/4"	6,5	11,7	310	1240	40	0,330	014 701 140	10-25-50
100 217 516	8	5/16"	8,1	13,2	250	1000	55	0,380	014 701 516	10-25-50
100 217 380	10	3/8"	9,8	15,5	225	900	65	0,460	014 701 380	10-25-50
100 217 120	12	1/2"	13	18,8	190	760	85	0,600	014 701 120	10-25-50



IMPIEGO

Tubo per alta pressione con copertura blu, progettato appositamente per sistemi di verniciatura a spruzzo e solventi con grande resistenza all'abrasione, resistenza meccanica e **conduttività elettrica**. Adatto a sistemi di verniciatura a spruzzo air-less che richiedono una superiore resistenza meccanica e/o conducibilità elettrica, applicazioni che necessitano di una superiore resistenza a solventi ed agenti chimici aggressivi. La **treccia in acciaio** offre maggior protezione meccanica rispetto ai tubi con treccia in fibra poliestere.

- Temperatura: - 40 °C +100 °C, limitata a +70 °C per aria e fluidi a base acquosa

STRUTTURA

- Sottostrato: Poliammide PA6.
- Rinforzi: **1 treccia in acciaio**.
- Copertura: poliuretano, **BLU**, non microforato, marcatura ink-jet bianca.
- Normative: SAE 100R1. Conforme o superiore alle specifiche di pressione di EN 853 1SN e EN 857 1SC

APPLICATION

High pressure hose with blue cover particularly designed for paint spray and solvent applications with increased resistance to abrasion mechanical strength and providing **electrical conductivity**. Suitable for airless paint spray systems requiring additional mechanical strength of hose and/or electrical conductivity, applications requiring high chemical resistance to solvents and aggressive fluids. **Steel braid** offers increased mechanical protection compared to yarn braided hoses.

- Temperature range: -40°C to +100°C, limited to +70°C for air and water based fluids.

CONSTRUCTION

- Tube: Polyamide PA6.
- Reinforcement: **1 braid of steel wire**.
- Cover: polyurethane, **BLUE**, non pinpricked, white ink-jet branding.
- According to: SAE 100R1. Meets or exceeds pressure specification of EN 853 1SN and EN 857 1SC



Codice Part Number	Diametro Interno Inside Diameter			Ø Esterno O.D.	Pr. Esercizio Max WP	Pr. Scoppio Burst Pr.	Raggio Curv. Bend Radius	Peso Weight	Boccola Ferrule	Lunghezza Length
	DN	Inch	mm							
TP3FS05	5	3/16"	5	9,7	360	1440	30	0,125	014 701 316	> 1
TP3FS06	6	1/4"	6,5	11,7	310	1240	40	0,165	014 701 140	> 1
TP3FS10	10	3/8"	9,8	15,5	225	900	65	0,230	014 701 380	> 1
TP3FS12	12	1/2"	13	18,8	190	760	85	0,300	014 701 120	> 1
TP3FS20	19	3/4"	19,5	25,8	115	460	145	0,460	014 701 340	> 1



IMPIEGO

Tubo ad alta pressione per fluidi a base di petrolio, sintetici e acquosi in sistemi oleodinamici. Adatto alla trasmissione idraulica di potenza in macchine movimento terra e agricole, carrelli elevatori, macchinari edili pesanti, apparecchi di sollevamento e handling, apparecchiature ad alta pressione. La **doppia treccia in acciaio** offre altissima resistenza meccanica che prolunga la durata del tubo anche in condizioni di lavoro molto severe. **Approvato da MSHA - Mine Safety and Health Administration - numero IC-305**.

- Temperatura: - 40 °C +100 °C, limitata a +70 °C per aria e fluidi a base acquosa

STRUTTURA

- Sottostrato: elastomero poliestere.
- Rinforzi: **2 treccia in acciaio**.
- Copertura: poliuretano, nero, non microforato, marcatura ink-jet bianca.
- Normative: Conforme ai requisiti di pressione SAE 100R2

APPLICATION

High pressure hose suitable for petroleum synthetic or water based hydraulic fluids in hydraulic systems. Suitable for general fluid power transmissions like earthmoving - forklifts trucks - HD construction machinery - hoisting and handling equipment - high pressure equipment. **Two steel braid design** offers very high mechanical strength which prolongs lifetime of the hose in harsh conditions. **Approved by MSHA - Mine Safety and Health Administration - number IC-305**.

- Temperature range: -40°C to +100°C, limited to +70°C for air and water based fluids.

CONSTRUCTION

- Tube: polyester elastomer.
- Reinforcement: **2 braids of steel wire**.
- Cover: polyurethane, black, non pinpricked, white ink-jet branding.
- According to: meets the pressure performance requirements of SAE 100R2
- According to: SAE 100R1. Meets or exceeds pressure specification of EN 853 1SN and EN 857 1SC



Codice Part Number	Diametro Interno Inside Diameter			Ø Esterno O.D.	Pr. Esercizio Max WP	Pr. Scoppio Burst Pr.	Raggio Curv. Bend Radius	Peso Weight	Boccola Ferrule	Lunghezza Length
	DN	Inch	mm							
TP2-06	6	1/4"	6,4	12,8	400	1600	40	0,245	XV04R2	> 1
TP2-08	8	5/16"	8,1	14,8	400	1600	55	0,315	XV05R2	> 1
TP2-10	10	3/8"	9,8	16,8	330	1320	65	0,375	XV06R2	> 1
TP2-12	12	1/2"	13	20,2	260	1040	85	0,460	XV08R2	> 1
TP2-16	16	5/8"	16,3	23,5	220	880	115	0,560	XV10R2	> 1
TP2-20	19	3/4"	19,5	27,8	150	600	170	0,715	XV12R2	> 1

700 bar



IMPIEGO

Superiore ai requisiti delle precedenti American Jacking Specifications IJ100 (1/4"). Tubo per altissime pressioni per fluidi a base di petrolio, sintetici ed acquosi in sistemi oleodinamici. La treccia combinata in **fibra aramidica acciaio** assicura durata, ottimo comportamento in pressione e design compatto. Idoneo per attrezzature di soccorso ad altissima pressione, impianti oleodinamici e pompe ad alta pressione, avvitatori idraulici, sistemi di sollevamento e rerailling. **Approvato da MSHA - Mine Safety and Health Administration - numero IC-305.**

- Temperatura: - 40 °C +100 °C, limitata a +70 °C per aria e fluidi a base acquosa

STRUTTURA

- Sottostrato: elastomero poliester.
- Rinforzi: **1 o 2 trecce di fibra aramidica più una treccia in acciaio.**
- Copertura: poliuretano, **ROSSO**, non microforato, marcatura ink-jet bianca.

APPLICATION

Exceeds the former American Jacking Specifications IJ100 (1/4"). Very High Pressure hose suitable for petroleum or synthetic or water based hydraulic fluids in hydraulic systems. Combined **Aramid Steel braid** ensures longevity pressure performance and compact design. Suitable for rescue and safety equipment, high pressure systems and pumps, bolt tensioning tools, jacking and rerailling equipment. **MSHA - Mine Safety and Health Administration - numero IC-305 approved.**

- Temperature range: -40°C to +100°C, limited to +70°C for air and water based fluids.

CONSTRUCTION

- Tube: polyester elastomer.
- Reinforcement: **1 or 2 braids of aramid fiber plus one braid of steel wire.**
- Cover: polyurethane, **RED**, non pinpricked, white ink-jet branding.



Codice Part Number	Diametro Interno Inside Diameter			Ø Esterno O.D.	Pr. Esercizio Max WP	Pr. Scoppio Burst Pr.	Raggio Curv. Bend Radius	Peso Weight	Boccola Ferrule	Lunghezza Length
	DN	Inch	mm							
TP10HS06RO	6	1/4"	6,6	12,7	700	2800	35	XJ04	XJ04HS	> 1
TP10HS10	10	3/8"	9,8	18,7	700	2800	90	XJ06	XJ06HS	> 1

TP10HS/BINATO



Codice Part Number	Diametro Interno Inside Diameter			Ø Esterno O.D.	Pr. Esercizio Max WP	Pr. Scoppio Burst Pr.	Raggio Curv. Bend Radius	Peso Weight	Boccola Ferrule	Lunghezza Length
	DN	Inch	mm							
TP10HS06Z-RO	6	1/4"	6,6	12,7	700	2800	35	XJ04	XJ04HS	> 1

700 bar



IMPIEGO

Superiore ai requisiti delle precedenti American Jacking Specifications. Tubo per altissime pressioni per fluidi a base di petrolio, sintetici ed acquosi in sistemi oleodinamici. La **doppia treccia in fibra aramidica** assicura durata, ottimo comportamento in pressione e design compatto. Idoneo per applicazioni che richiedano elevato isolamento elettrico o non conduttività in ambiente ad alta tensione. I tubi sono conformi agli standard SAE J517/J343 e EN855 per non conduttività dove la dispersione massima elettrica non deve eccedere 50µA quando un campione di 152 mm è soggetto a 37.5 KV per 5 minuti, equivalenti a 250 KV/metro.

- Temperatura: - 40 °C +100 °C, limitata a +70 °C per aria e fluidi a base acquosa

STRUTTURA

- Sottostrato: elastomero poliester.
- Rinforzi: **2 trecce di fibra aramidica.**
- Copertura: Poliuretano, **ARANCIONE**, marcatura ink-jet nera.
- Normative: Conforme ai requisiti di pressione SAE 100R2

APPLICATION

Exceeds the former American Jacking Specifications. Very High Pressure hose suitable for petroleum or synthetic based hydraulic fluids in hydraulic systems. **Aramid braid** ensures longevity as well as pressure performance and compact design. Suitable for applications requiring electrical high insulation or non-conductivity in high tension environment e.g. near electrical power lines. Hoses meet standards SAE J517/J343 and EN855 for non conductivity where maximum electrical leakage shall not exceed 50µA when a 152 mm sample is subject to 37.5 KV for 5 minutes equivalent to 250 KV/meter.

- Temperature range: -40°C to +100°C, limited to +70°C for air and water based fluids.

CONSTRUCTION

- Tube: polyester elastomer.
- Reinforcement: **1 braids of aramid fiber.**
- Cover: polyurethane, **ORANGE**, black ink-jet branding.
- According to: meets the pressure performance requirements of SAE 100R2



Codice Part Number	Diametro Interno Inside Diameter			Ø Esterno O.D.	Pr. Esercizio Max WP	Pr. Scoppio Burst Pr.	Raggio Curv. Bend Radius	Peso Weight	Boccola Ferrule	Lunghezza Length
	DN	Inch	mm							
TP10HS06RO	6	1/4"	6,6	12,7	700	2800	35	XJ04	XJ04HS	> 1
TP10HS10	10	3/8"	9,8	18,7	700	2800	90	XJ06	XJ06HS	> 1

TP10HSNC/BINATO



Codice Part Number	Diametro Interno Inside Diameter			Ø Esterno O.D.	Pr. Esercizio Max WP	Pr. Scoppio Burst Pr.	Raggio Curv. Bend Radius	Peso Weight	Boccola Ferrule	Lunghezza Length
	DN	Inch	mm							
TP10HS/NC-Z04	4	1/8"	4,0	9,1	700	2800	25	XJ02	XJ02HL	> 1



TUBI GOMMA ALTA PRESSIONE
HIGH PRESSURE RUBBER HOSES

TUBI ALTISSIMA PRESSIONE
ULTRA-HIGH PRESSURE HOSES



IMPIEGO

Tubi termoplastici per altissime pressioni ideati per una vasta gamma di applicazioni: Tecnologia dell'Idrogetto ad Altissima Pressione (**Waterblasting**), applicazioni **Oleodinamiche** ad Altissima Pressione, **Industria Petroliera e dell'Estrazione** (Miniere, Cave, ecc.), **Industria Automobilistica, Ingegneria Civile** in genere e applicata alle **Infrastrutture viarie, Industria Navale, Industria in genere** nonché per la **pulizia di ogni tipo di superficie**. Grazie alla loro particolare struttura, pesano fino al 50% in meno rispetto agli equivalenti tubi in gomma, hanno un raggio di curvatura molto ridotto ad alti volumi di portata, sono altamente resistenti all'ozono, ai raggi ultravioletti ed all'invecchiamento, hanno un'ottima resistenza ai prodotti chimici, detersivi e solventi e la copertura esterna ha un'elevata resistenza all'abrasione e una colorazione diversa a seconda delle caratteristiche tecniche/costruttive.

STRUTTURA

- Diametri interni: da 3/16" a 1".
- Sottostrato: a seconda delle esigenze anima interna costruita in poliammide (PA), polioossimetilene (POM), fluoruro di polivinilidene (PVDF) o politetrafluoroetilene (PTFE).
- Rinforzi: in base al campo di applicazione 2, 4, 6 o 8 spirali di filo di acciaio ad alta resistenza.
- Copertura: mescola in poliammide (PA), poliuretano (PUR) o fluoruro di polivinilidene (PVDF).
- Pressione di Esercizio: **fino 3.200 bar**.
- Temperatura: da -30°C a +200°C

APPLICATION

Ultra-high pressure thermoplastic hoses suitable for a wide range of applications: **Waterblasting** Technology, Ultra-High Pressure **Hydraulics, Oil and Extraction** Industry (Mining, Quarrying, etc.), **Automotive** Industry, **Civil Engineering** in general and applied to **Infrastructures, Marine Industry, Industry in general** as well as for **surface cleaning of any kind**.

Thanks to their particular structure, they weigh up to 50% less than the comparative rubber hoses, they have small bend radius at high volumes of flow, have resistant to ozone, ultraviolet light and aging, have excellent resistance to chemical products, detergents and solvents and the outer cover have high resistance against abrasion and a different color according to the technical/constructive features.

CONSTRUCTION

- Inner diameters: from 3/16" to 1".
- Tube: according to the requirements inner core made of polyamide (PA), polyoxymethylene (POM), polyvinylidene fluoride (PVDF) or polytetrafluoroethylene (PTFE).
- Reinforcement: depending on the field of application 2, 4, 6 or 8 spiral layers of highly tensile steel wire.
- Cover: polyamide (PA), polyurethane (PUR) or polyvinylidene fluoride (PVDF) special compound.
- Working Pressure: **to 3.200 bar**.
- Temperature range: from -30°C to +200°C

IDROGETTO AD ALTISSIMA PRESSIONE "Waterblasting"



- Spurgo Fogne;
- Pulizia di condotte;
- Pulizia di interno ed esterno degli scambiatori di calore;
- Taglio a getto d'acqua di qualsiasi materiale;
- Lavori di ristrutturazione edili e grossi lavori di infrastrutture viarie;

- Pulizia di carene e qualsiasi oggetto nell'industria Navata;
- Applicazioni nel settore Truck ed Automotive;
- Pulizia di ogni tipo di superficie.

APPLICAZIONI IDRAULICHE GRAVOSE

Ultra-High Pressure Hydraulics

- Applicazioni a pressione estreme (autofrettage) ;
- Modellazione ad alta pressione (hydroforming);
- Assemblaggio presse idrauliche;
- Utensili ed attrezzature idrauliche ad alta pressione;
- Tensionamento senza torsione di collegamenti a vite;



APPLICAZIONI NEL SETTORE PETROLIFERO

Oil & Gas Applications

- Adduzione di metanolo sulle piattaforme petrolifere;
- Iniezione di prodotti chimici nei pozzi petroliferi;
- Manutenzione di sistemi di controllo e applicazioni ad alta pressione e temperatura;



ALTISSIMA PRESSIONE

Al fine di garantire la massima sicurezza, i Tubi Termoplastici per Altissima Pressione sono forniti già raccordati. I tubi ed i raccordi montati vengono prodotti con metodi di produzione all'avanguardia e alti standard di qualità progettati appositamente a seconda dei campi di applicazione: per lo spurgo delle tubazioni strutturalmente più corti per facilitare la pulizia dei gomi, assemblati con boccole di diametro esterno ridotto per permettere l'utilizzo con maggiore flusso, a seconda dell'esigenza in acciaio inox ad alta resistenza, con tutti i tipi di connessione relativi allo specifico campo di utilizzo richiesto. Tutti i tubi flessibili sono collaudati con attrezzature all'avanguardia al fine di garantire che vengano consegnati solo prodotti di altissima qualità. Su richiesta, può essere rilasciato un certificato di prova conforme alle norme EN 10204 per ogni tubo flessibile assemblato.

È disponibile una vasta gamma di adattatori, raccordi e valvole ad altissima pressione progettata specificatamente per applicazioni gravose nel settore del Waterblast, delle applicazioni idrauliche ad altissima pressione e nel settore petrolifero. Il materiale standard di costruzione è AISI 316 per supportare le alte temperature e le alti pressioni tipiche in queste applicazioni. Le connessioni hanno filettature NPT, JIC e tipo M e hanno un range di pressione d'esercizio che va da 690 a 4138 bar.





TUBI GOMMA ALTA PRESSIONE
HIGH PRESSURE RUBBER HOSES

TUBI GOMMA
BASSA/MEDIA PRESSIONE
LOW/MEDIUM PRESSURE
RUBBER HOSES



IMPIEGO

TUBO BASSA PRESSIONE idoneo per linee idrauliche di ritorno, drenaggio e mandata di fluidi idraulici, olii, lubrificanti, nafta ed aria.

- Temperatura: -40°C +100°C

STRUTTURA

- Sottostrato: liscio in gomma NBR nera.
- Rinforzi: **1 treccia di filato sintetico ad alta resistenza.**
- Copertura: in gomma CR resistente all'abrasione, agli olii e agli agenti atmosferici.
- Normative: DIN EN 854 Tipo R6 / SAE J517 100 R6

Disponibile su richiesta:
con rivestimento in treccia di cotone nero; con rivestimento in calza di acciaio zincato; con rivestimento in treccia di cotone nero e in calza di acciaio zincato; con rivestimento in calza di acciaio inox

APPLICATION

LOW PRESSURE HOSE suitable for hydraulic lines of return, draining and delivery of hydraulic fluid, oils, lubricants and air.

- Temperature range: -40°C +100°C

CONSTRUCTION

- Tube: black, smooth NBR rubber.
- Reinforcement: **1 high strength syntetic textile braid.**
- Cover: black, abrasion, oils and weathering resistant CR rubber.
- According to: DIN EN 854 R6 / SAE J517 100 R6

Available on request:
black cotton braid cover; galvanized steel wire braid cover; black cotton braid and galvanized steel wire braid cover; stainless steel wire braid cover.



Codice Part Number	Diametro Interno Inside Diameter			Ø Esterno O.D.	Pr. Esercizio Max WP	Pr. Scoppio Burst Pr.	Raggio Curv. Bend Radius	Peso Weight	Boccola Ferrule	Lunghezza Lenght
	DN	Inch	mm							
100 006 316	5	3/16"	4,8	11,1	34	136	50	0,10	014 660 316	> 20
100 006 140	6	1/4"	6,4	12,7	28	112	65	0,12	014 660 140	25-50-100
100 006 516	8	5/16"	7,9	14,3	28	112	80	0,14	014 660 516	25-50-100
100 006 380	10	3/8"	9,5	15,9	28	112	90	0,16	014 660 380	25-50-100
100 006 120	12	1/2"	12,7	19,8	28	112	100	0,23	014 660 120	25-50-100
100 006 580	16	5/8"	15,9	23	24	96	125	0,27	014 660 580	25-50-100
100 006 340	19	3/4"	19	27	21	84	140	0,34	014 660 340	10-25-50
100 006 100	25	1"	25,4	34,5	17	68	170	0,54	014 660 100	10-25-50



IMPIEGO

TUBO BASSA PRESSIONE idoneo per linee idrauliche di ritorno e mandata di fluidi idraulici, olii, lubrificanti, nafta ed aria.

- Temperatura: -40°C +100°C

STRUTTURA

- Sottostrato: liscio in gomma NBR nera.
- Rinforzi: **2 trecce di filato sintetico ad alta resistenza.**
- Copertura: in gomma CR resistente all'abrasione, agli olii e agli agenti atmosferici.
- Normative: DIN EN 854 Tipo R3 / SAE J517 100 R3

Disponibile su richiesta:
con rivestimento in calza di acciaio zincato; con rivestimento in calza di acciaio inox

APPLICATION

LOW PRESSURE HOSE suitable for hydraulic lines of return and delivery of hydraulic fluid, oils, lubricants and air.

- Temperature range: -40°C +100°C

CONSTRUCTION

- Tube: black, smooth NBR rubber.
- Reinforcement: **2 high strength syntetic textile braids.**
- Cover: black, abrasion, oils and weathering resistant CR rubber.
- According to: DIN EN 854 R3 / SAE J517 100 R3

Available on request:
galvanized steel wire braid cover; stainless steel wire braid cover.



Codice Part Number	Diametro Interno Inside Diameter			Ø Esterno O.D.	Pr. Esercizio Max WP	Pr. Scoppio Burst Pr.	Raggio Curv. Bend Radius	Peso Weight	Boccola Ferrule	Lunghezza Lenght
	DN	Inch	mm							
100 003 140	6	1/4"	6,4	14,3	86	344	80	0,18	014 340 140	> 20
100 003 516	8	5/16"	7,9	17,5	83	332	100	0,27	014 340 516	> 20
100 003 380	10	3/8"	9,5	19,1	78	312	100	0,29	014 340 380	> 20
100 003 120	12	1/2"	12,7	23,8	69	276	125	0,42	014 340 120	> 20
100 003 580	16	5/8"	15,9	27	60	240	140	0,49	014 340 580	> 20
100 003 340	19	3/4"	19	31,8	52	208	150	0,68	014 340 340	> 20
100 003 100	25	1"	25,4	38,1	39	156	205	0,84	014 340 100	> 20



IMPIEGO

TUBO BASSA PRESSIONE idoneo per linee idrauliche di ritorno e mandata di fluidi idraulici, olii, lubrificanti, nafta ed aria.
• Temperatura: -40°C +100°C

STRUTTURA

- Sottostrato: liscio in gomma NBR nera.
- Rinforzi: **1 treccia di filato sintetico ad alta resistenza.**
- Copertura: in gomma CR resistente all'abrasione, agli olii e agli agenti atmosferici.
- Normative: DIN EN 854 Tipo 2TE / DIN 20021 2TE

Disponibile su richiesta:
con rivestimento in calza di acciaio zincato; con rivestimento in calza di acciaio inox.

APPLICATION

LOW PRESSURE HOSE suitable for hydraulic lines of return and delivery of hydraulic fluid, oils, lubricants and air.
• Temperature range: -40°C +100°C

CONSTRUCTION

- Tube: black, smooth NBR rubber.
- Reinforcement: **1 high strength synthetic textile braid.**
- Cover: black, abrasion, oils and weathering resistant CR rubber.
- According to: DIN EN 854 2TE / DIN 20021 2TE

Available on request:
galvanized steel wire braid cover; stainless steel wire braid cover.



Codice Part Number	Diametro Interno Inside Diameter			Ø Esterno O.D.	Pr. Esercizio Max WP	Pr. Scoppio Burst Pr.	Raggio Curv. Bend Radius	Peso Weight	Boccola Ferrule	Lunghezza Length
	DN	Inch	mm							
100 102 140	6	1/4"	6.4	13.5	75	300	40	0.14	014 660 140	> 20
100 102 516	8	5/16"	7.9	15	68	272	50	0.16	014 660 516	> 20
100 102 380	10	3/8"	9.5	16.5	63	252	60	0.18	014 660 380	> 20
100 102 120	12	1/2"	12.7	19.7	58	232	70	0.24	014 660 120	> 20
100 102 580	16	5/8"	15.9	24	50	200	90	0.32	014 660 580	> 20
100 102 340	19	3/4"	19	27	45	180	110	0.38	014 660 340	> 20
100 102 100	25	1"	25.4	34.5	40	160	150	0.56	014 660 100	> 20

• Fornibile in 7 gg lavorativi / Available in 7 working days



IMPIEGO

TUBO BASSA/MEDIA PRESSIONE idoneo per linee idrauliche di mandata di fluidi idraulici, olii, lubrificanti, nafta ed aria.
• Temperatura: -40°C +100°C

STRUTTURA

- Sottostrato: liscio in gomma NBR nera.
- Rinforzi: **2 trecce di filato sintetico ad alta resistenza.**
- Copertura: in gomma CR resistente all'abrasione, agli olii e agli agenti atmosferici.
- Normative: DIN EN 854 Tipo 3TE / DIN 20021 3TE

Disponibile su richiesta:
con rivestimento in calza di acciaio zincato; con rivestimento in calza di acciaio inox

APPLICATION

LOW/MEDIUM PRESSURE HOSE suitable for hydraulic lines of delivery of hydraulic fluid, oils, lubricants and air.
• Temperature range: -40°C +100°C

CONSTRUCTION

- Tube: black, smooth NBR rubber.
- Reinforcement: **2 high strength synthetic textile braids.**
- Cover: black, abrasion, oils and weathering resistant CR rubber.
- According to: DIN EN 854 3TE / DIN 20021 3TE

Available on request:
galvanized steel wire braid cover; stainless steel wire braid cover.



Codice Part Number	Diametro Interno Inside Diameter			Ø Esterno O.D.	Pr. Esercizio Max WP	Pr. Scoppio Burst Pr.	Raggio Curv. Bend Radius	Peso Weight	Boccola Ferrule	Lunghezza Length
	DN	Inch	mm							
100 103 140	6	1/4"	6.4	14.4	145	580	45	0.19	014 340 140	> 20
100 103 380	10	3/8"	9.5	18.5	110	440	70	0.27	014 340 380	> 20
100 103 120	12	1/2"	12.7	21.7	93	372	85	0.34	014 340 120	> 20
100 103 340	19	3/4"	19	29	70	280	130	0.50	014 340 340	> 20
100 103 100	25	1"	25.4	36	55	220	150	0.67	014 340 100	> 20

• Fornibile in 7 gg lavorativi / Available in 7 working days

OIL



IMPIEGO

TUBO BASSA PRESSIONE liscio con spirale metallica incorporata idoneo per aspirazione e mandata di fluidi idraulici, olii minerali.

- Temperatura: -40°C +93°C

STRUTTURA

- Sottostrato: liscio in gomma nera NBR resistente ai prodotti petroliferi con contenuto aromatico non superiore al 50%.
- Rinforzi: **spirale metallica** incorporata con tessuti sintetici ad alta resistenza.
- Copertura: gomma nera CR/NBR resistente all'abrasione, al calore, agli olii, ai carburanti e agli agenti atmosferici.
- Normative: Tipo SAE 100 R4

Disponibile su richiesta: rivestimento in calza di acciaio zincato; rivestimento in calza di acciaio inox.

APPLICATION

LOW PRESSURE HOSE smooth with steel wire helix for suction and delivery of hydraulic fluids, mineral oils.

- Temperature range: -40°C +93°C

CONSTRUCTION

- Tube: black, smooth, petroleum products up to 50% aromatic content resistant NBR rubber.
- Reinforcement: **steel wire helix** with high strength synthetic textile plies.
- Cover: black, abrasion, heat, oils, fuels and weathering resistant CR/NBR rubber.
- According to: Type SAE 100 R4.

Available on request: galvanized steel wire braid cover; stainless steel wire braid cover.



Codice Part Number	Diametro Interno Inside Diameter		Ø Esterno O.D.	Pr. Esercizio Max WP	Pr. Scoppio Burst Pr.	Raggio Curv. Bend Radius	Aspirazione Vacuum	Peso Weight	Lunghezza Lenght
	Inch	mm							
100 104 580	5/8"	16	26	21	83	50	0,8	0,45	40-61
100 104 340	3/4"	19	29	21	83	60	0,8	0,58	40-61
100 104 100	1"	25	36	17	69	75	0,8	0,69	40-61
100 141 316	1.3/16"	30	42	16	65	90	0,8	0,86	40-61
100 104 114	1.1/4"	32	43	14	55	100	0,8	0,87	40-61
100 141 380	1.3/8"	35	47	12	50	105	0,8	1,01	40-61
100 104 112	1.1/2"	38	49	10	41	115	0,8	1,05	40-61
100 141 916	1.9/16"	40	52	10	41	120	0,8	1,08	40-61
100 141 340	1.3/4"	45	58	8	30	135	0,8	1,35	40-61
100 104 200	2"	51	63	7	28	200	0,8	1,56	40-61

SUPER FLESSIBILE IDONEO PER CARBURANTI



IMPIEGO

TUBO BASSA PRESSIONE liscio con spirale metallica incorporata idoneo per aspirazione e mandata di fluidi idraulici, olii minerali e **CARBURANTI**.

- Temperatura: -40°C +93°C

STRUTTURA

- Sottostrato: liscio in gomma nera NBR antistatica resistente ai prodotti petroliferi con contenuto aromatico non superiore al 50%.
- Rinforzi: **spirale metallica** incorporata con tessuti sintetici ad alta resistenza. **Cordicella di rame**.
- Copertura: gomma nera CR/NBR resistente all'abrasione, al calore, agli olii, ai carburanti e agli agenti atmosferici.
- Normative: Tipo SAE 100 R4

Disponibile su richiesta: rivestimento in calza di acciaio zincato; rivestimento in calza di acciaio inox.

APPLICATION

LOW PRESSURE HOSE smooth with steel wire helix for suction and delivery of hydraulic fluids, mineral oils and **FUEL**.

- Temperature range: -40°C + 93°C

CONSTRUCTION

- Tube: black, smooth, petroleum products up to 50% aromatic content resistant antistatic NBR rubber.
- Reinforcement: **steel wire helix** with high strength synthetic textile plies. **Copper wire**.
- Cover: black, abrasion, heat, oils, fuels and weathering resistant CR/NBR rubber.
- According to: Type SAE 100 R4.

Available on request: galvanized steel wire braid cover; stainless steel wire braid cover.



Codice Part Number	Diametro Interno Inside Diameter		Ø Esterno O.D.	Pr. Esercizio Max WP	Pr. Scoppio Burst Pr.	Raggio Curv. Bend Radius	Aspirazione Vacuum	Peso Weight	Lunghezza Lenght
	Inch	mm							
100 004 120	1/2"	13	23	10	30	50	0,8	0,43	10-20-40
100 004 580	5/8"	16	26	10	30	50	0,8	0,47	10-20-40
100 004 340	3/4"	19	29	21	84	50	0,8	0,57	10-20-40
100 004 780	7/8"	22	32	10	30	70	0,8	0,61	10-20-40
100 004 100	1"	25	36	17	68	70	0,8	0,74	10-20-40
100 041 316	1.3/16"	30	42	10	30	90	0,8	0,97	10-20-40
100 004 114	1.1/4"	32	43	14	56	90	0,8	1,03	10-20-40
100 041 380	1.3/8"	35	47	10	30	100	0,8	1,18	10-20-40
100 004 112	1.1/2"	38	49	10	30	100	0,8	1,20	10-20-40
100 041 916	1.9/16"	40	52	10	30	120	0,8	1,30	10-20-40
100 041 232	1.2/32"	42	55	10	30	120	0,8	1,50	10-20-40
100 041 340	1.3/4"	45	58	10	30	120	0,8	1,63	10-20-40
100 004 200	2"	51	63	10	30	305	0,8	1,70	10-20-40

SEGUE A PAG. 61 / Follow to pag. 61

SUPER FLESSIBILE IDONEO PER CARBURANTI



IMPIEGO

TUBO BASSA PRESSIONE liscio con spirale metallica incorporata idoneo per aspirazione e mandata di fluidi idraulici, olii minerali e **CARBURANTI**.

- Temperatura: -40°C +100°C

STRUTTURA

- Sottostrato: liscio in gomma nera NBR antistatica resistente ai prodotti petroliferi con contenuto aromatico non superiore al 50%.
- Rinforzi: **spirale metallica** incorporata con tessuti sintetici ad alta resistenza. **Cordicella di rame**.
- Copertura: gomma nera CR/NBR resistente all'abrasione, al calore, agli olii, ai carburanti e agli agenti atmosferici.
- Normative: Tipo SAE 100 R4

Disponibile su richiesta:
rivestimento in calza di acciaio zincato; rivestimento in calza di acciaio inox.

APPLICATION

LOW PRESSURE HOSE smooth with steel wire helix for suction and delivery of hydraulic fluids, mineral oils and **FUEL**.

- Temperature range: -40°C +100°C

CONSTRUCTION

- Tube: black, smooth, petroleum products up to 50% aromatic content resistant antistatic NBR rubber.
- Reinforcement: **steel wire helix** with high strength synthetic textile plies. **Copper wire**.
- Cover: black, abrasion, heat, oils, fuels and weathering resistant CR/NBR rubber.
- According to: Type SAE 100 R4.

Available on request:
galvanized steel wire braid cover; stainless steel wire braid cover.



Codice Part Number	Diametro Interno Inside Diameter		Ø Esterno O.D.	Pr. Esercizio Max WP	Pr. Scoppio Burst Pr.	Raggio Curv. Bend Radius	Aspirazione Vacuum	Peso Weight	Lunghezza Lenght
	Inch	mm							
100 042 160	2.1/6"	55	67	10	30	180	0,8	2,05	10-20-40
100 042 380	2.3/8"	60	74	10	30	340	0,8	2,15	10-20-40
100 042 120	2.1/2"	63,5	77	10	30	340	0,8	2,50	10-20-40
100 042 340	2.3/4"	70	85	10	30	420	0,8	2,75	10-20
100 004 300	3"	76	91	10	30	460	0,8	3,10	10-20
100 043 532	3.5/32"	80	95	10	30	480	0,8	3,55	10-20
100 043 732	3.17/32"	90	106	10	30	520	0,8	4,10	10-20
100 004 400	4"	102	118	10	30	610	0,8	4,50	10-20
100 004 434	4.3/4"	120	139	10	30	810	0,8	6,00	10-20



IMPIEGO

TUBO BASSA PRESSIONE in gomma con spirale metallica grecato idoneo per aspirazione e mandata di **olii e carburanti**.

- Temperatura: -35°C +80°C

STRUTTURA

- Sottostrato: liscio in gomma nera NBR resistente ai prodotti petroliferi con contenuto aromatico non superiore al 50%.
- Rinforzi: **spirale metallica** incorporata con tessuti sintetici ad alta resistenza.
- Copertura: **grecata** in gomma nera NBR/EPDM resistente all'abrasione, agli agenti atmosferici ed all'ozono.

APPLICATION

LOW PRESSURE HOSE hardwall square corrugated cover rubber hose suitable for suction and delivery of **oils and fuels**.

- Temperature range: -35°C +80°C

CONSTRUCTION

- Tube: black, smooth, petroleum products up to 50% aromatic content resistant NBR rubber.
- Reinforcement: **steel wire helix** with high strength synthetic textile plies.
- Cover: **square corrugated**, black, abrasion, weathering and ozone resistant NBR/EPDM rubber.



Codice Part Number	Diametro Interno Inside Diameter		Ø Esterno O.D.	Pr. Esercizio Max WP	Pr. Scoppio Burst Pr.	Raggio Curv. Bend Radius	Aspirazione Vacuum	Peso Weight	Lunghezza Lenght
	Inch	mm							
100 092 030	25/32"	20	30	5	15	60	0,8	0,61	20
100 092 535	1"	25	35	5	15	75	0,8	0,69	20
100 093 040	1.3/16"	30	40	5	15	90	0,8	0,95	20
100 093 242	1.1/4"	32	42	5	15	100	0,8	1,00	20
100 093 545	1.3/8"	35	45	5	15	105	0,8	1,04	20
100 093 848	1.1/2"	38	48	5	15	115	0,8	1,20	20
100 094 050	1.9/16"	40	50	5	15	120	0,8	1,28	20
100 094 555	1.3/4"	45	55	5	15	135	0,8	1,40	20
100 095 161	2"	51	61	5	15	155	0,8	1,50	20



TUBI SETTORE INDUSTRIALE
INDUSTRIAL SECTION HOSES

TUBI PER OLII E CARBURANTI
OILS & FUELS HOSES

AD BLUE® RESISTANT



IMPIEGO

TUBO BASSA PRESSIONE costruito con una **mescola speciale** in gomma idoneo al passaggio di acqua, aria, olio, petrolio-benzina, grassi, acidi moderati e alcali, letame, prodotti fitosanitari e **AdBlue®**.

Grazie alla sua particolare struttura **trova impiego in tantissime e svariate applicazioni**: agricoltura, movimento terra, industria in genere, settore auto, veicoli industriali, edilizia ecc.

- Temperatura: -20°C +70°C

STRUTTURA

- Sottostrato: mescola speciale a base **NBR/PVC/PU** nera liscia.
- Rinforzi: **poliestere ad alta resistenza**.
- Copertura: mescola speciale a base **NBR/PVC/PU** nera liscia resistente all'abrasione, oli, ozono e agenti atmosferici.

Disponibile su richiesta:
rivestimento MICROPERFORATO per passaggio di GAS compatibili – ARIA.

APPLICATION

LOW PRESSURE HOSE made with a **special compound** rubber suitable for passage of water, air, oil, oil-gas, fat, mild acids and alkalis, manure, pesticides and **AdBlue®**.

Thanks to its particular structure **is used in many and various applications**: agriculture, earth-moving, general industry, automotive, trucks, construction etc..

- Temperature range: -20°C +70°C

CONSTRUCTION

- Tube: special compound **NBR/PVC/PU** black smooth.
- Reinforcement: **high tensile polyester**.
- Cover: black **NBR/PVC/PU** smooth special compound resistant to abrasion, oil, ozone and weathering.

Available on request:
micro perforated cover for AIR and compatible GAS conduction.



Codice Part Number	Diametro Interno Inside Diameter		Ø Esterno O.D.	Pr. Esercizio Max WP	Pr. Scoppio Burst Pr.	Raggio Curv. Bend Radius	Peso Weight	Boccola Ferrule	Lunghezza Lenght	
	DN	Inch.								mm
101 110 612	6	1/4"	6,0	12,0	25	75	40	0,110	014701140	25-50-100
101 110 815	8	5/16"	8,0	15,0	25	75	50	0,170	014701516	25-50-100
101 110 916	9		9,0	16,0	25	75	50	0,185		25-50-100
101 111 017	10	3/8"	10,0	17,0	25	75	60	0,200	014701380	25-50-100
101 111 321	13	1/2"	13,0	21,0	25	75	80	0,280	014120120	25-50-100
101 111 624	16	5/8"	16,0	24,0	25	75	95	0,330	014120580	10-25-50
101 111 928	19	3/4"	19,0	28,0	25	75	110	0,440	014120340	10-25-50
101 112 535	25	1"	25,0	36,0	25	75	125	0,650	014120100	10-25-50

⚠ Taglio a misura applicato sovrapprezzo di 15,00 euro / Cut To Size Applied Supplement of 15 Euro

TUBO SPECIALE
UNIVERSALE

UN TUBO & INFINITE APPLICAZIONI
One hose & many applications



- Estremamente morbido e flessibile per molteplici campi di applicazione;
- Condotta interna in una mescola speciale che garantisce compatibilità con tanti fluidi;
- Permette di ridurre notevolmente le scorte di magazzino;
- Pressione d'esercizio 25 bar per tutti i diametri.

IDONEO PER INIETTORI - SUITABLE FOR INJECTION



IMPIEGO

Tubo in gomma idoneo per adduzione di olio motore (HD), diesel, olio combustibile, olii contenenti tracce di aria, fluidi idraulici a base di minerali e glicole, grassi vegetali.

- Temperatura: -40°C +135°C punte di +150°

STRUTTURA

- Sottostrato: nero in gomma sintetica speciale.
- Rinforzi: **PE tessile altamente resistente.**
- Copertura: in gomma nera sintetica speciale resistente all'abrasione, agli olii, all'ozono e agli agenti atmosferici.
- Superficie: liscia ad impressione tela.
- Marcatura: ad inchiostro "OIL M4M ContiTech®"

APPLICATION

Rubber hose suitable for engine lubricating oils, diesel fuels, fuel oil, oil containing air, hydraulic fluids on mineral and glycol base, herbal greases.

- Temperature range: -40° C +135° C peak of +150° C

CONSTRUCTION

- Tube: black special synthetic rubber.
- Reinforcement: **highly resistant textile PE.**
- Cover: black, abrasion, fuels, oils and weathering resistant nitrilic antistatic rubber (R<1M ÷/m).
- Surface: smooth fabric finished.
- Branding: ink marking "HSR - TCS / 40 - 6x3 - WP 40 BAR - BP 250 BAR "



Codice Part Number	Diametro Interno Inside Diameter			Ø Esterno O.D.	Pr. Esercizio Max WP	Pr. Scoppio Burst Pr.	Raggio Curv. Bend Radius	Peso Weight	Lunghezza Lenght
	DN	Inch.	mm						
100 000 612	6	1/4"	6	12	-09 -50	150	40	0,095	>10
100 000 814	8	5/16"	8	14	-09 -35	105	50	0,125	>10
100 000 915	9	9	15,5	-09 -30	90	55	0,140	>10	



IMPIEGO

Tubo in gomma long length idoneo per adduzione di olii minerali, diesel e benzine ecologiche.

- Temperatura: -35° C +90° C

STRUTTURA

- Sottostrato: liscio in gomma nera NBR resistente ai prodotti petroliferi con contenuto aromatico non superiore del 50%.
- Rinforzi: inserzioni di filati sintetici ad alta resistenza.
- Copertura: in gomma nera nitrilica antistatica (R<1M ÷/m) resistente all'abrasione, ai carburanti, agli olii e agli agenti atmosferici.
- Superficie: liscia estrusa.
- Normative: ISO R 1307

Disponibili su richiesta:
rivestimento in calza di acciaio zincato; rivestimento in calza di acciaio inox.

APPLICATION

Long length rubber hose suitable for loading of mineral oils, diesel and unleaded fuel.

- Temperature range: -35° C +90° C

CONSTRUCTION

- Tube: black, smooth, petroleum products up to 50% aromatic NBR rubber.
- Reinforcement: high strength syntetic textile yarn.
- Cover: black, abrasion, fuels, oils and weathering resistant nitrilic antistatic rubber (R<1M ÷/m).
- Surface: smooth extruded.
- According to: ISO R 1307

Available on request:
galvanized steel wire braid cover; stainless steel wire braid cover.



Codice Part Number	Diametro Interno Inside Diameter			Ø Esterno O.D.	Pr. Esercizio Max WP	Pr. Scoppio Burst Pr.	Raggio Curv. Bend Radius	Peso Weight	Lunghezza Lenght
	DN	Inch.	mm						
100 010 512	5	3/16"	5	12	10	30	40	0,130	25 - 50 - 100
100 010 612	6	1/4"	6	12	10	30	50	0,120	25 - 50 - 100
100 010 713	7	5/18"	7	13	10	30	55	0,130	25 - 50 - 100
100 010 815	8	5/16"	8	15	10	30	65	0,180	25 - 50 - 100
100 011 017	10	3/8"	10	17	10	30	80	0,210	25 - 50 - 100
100 011 320	12	1/2"	13	20	10	30	105	0,260	25 - 50 - 100
100 011 523	15	19/32"	15	23	10	30	120	0,340	25 - 50 - 100
100 011 927	19	3/4"	19	27	10	30	150	0,400	20 - 60
100 012 028	20	3/4"	20	28	10	30	155	0,450	50
100 012 535	25	1"	25	35	10	30	200	0,660	25 - 50



IMPIEGO

Tubo in gomma long length idoneo per mandata di carburanti nei motori a combustione interna, lubrificazione ed ingrassaggio di macchinari; particolarmente indicato ove siano richieste caratteristiche di leggerezza e flessibilità.

- Temperatura: -35° C +70° C

STRUTTURA

- Sottostrato: liscio in gomma nbr di colore nero resistente ad oli e carburanti con contenuto di aromatici fino al 40%.
- Rinforzi: inserzioni di filati sintetici ad alta resistenza.
- Copertura: liscia in gomma NBR resistente ad oli e carburanti.
- Superficie: liscia estrusa.
- Normative: ISO R 1307

Disponibili su richiesta: rivestimento in calza di acciaio zincato; rivestimento in calza di acciaio inox.

APPLICATION

Long length rubber hose suitable for For delivery of fuels in internal combustion engines for lubrication and greasing services. Especially recommended where this is required characteristics of light weight and flexibility.

- Temperature range: -35° C +70° C

CONSTRUCTION

- Tube: black, smooth, petroleum products up to 40% aromatic NBR rubber.
- Reinforcement: high strength syntetic textile yarn.
- Cover: Abrasion, ozone, weather and oil resistant special synthetic rubber.
- Surface: smooth extruded.
- According to: ISO R 1307

Available on request: galvanized steel wire braid cover; stainless steel wire braid cover.



Codice Part Number	Diametro Interno Inside Diameter			Ø Esterno O.D.	Pr. Esercizio Max WP	Pr. Scoppio Burst Pr.	Raggio Curv. Bend Radius	Peso Weight	Lunghezza Length
	DN	Inch.	mm						
100 110 612	6	1/4"	6	14	20	60	60	0,168	25 - 100
100 110 815	8	5/16"	8	17	20	60	80	0,237	25 - 100
100 111 017	10	3/8"	10	19	20	60	100	0,275	25 - 100



IMPIEGO

Tubo in gomma long length idoneo per adduzione di diesel e benzine ecologiche per **alimentazione dei motori fuori bordo**. Ottima flessibilità anche a basse temperature.

- Temperatura: -40° C +110° C

STRUTTURA

- Sottostrato: liscio in gomma nera NBR resistente alle benzine ecologiche con contenuto aromatico non superiore al 50%.
- Rinforzi: inserzioni di filati sintetici ad alta resistenza.
- Copertura: in gomma nera autoestinguente NBR/CR resistente all'abrasione, al calore, ai carburanti, all'ozono e all'invecchiamento.
- Superficie: liscia estrusa.
- Normative: **DIN 73379, tipo 2A**

APPLICATION

Long length rubber hose suitable for loading diesel and unleaded fuels, for **outboard engines**. Good flexibility at low temperature too.

- Temperature range: -40° C +110° C

CONSTRUCTION

- Tube: black, smooth, petroleum products up to 50% aromatic NBR rubber.
- Tube: black, smooth, unleaded fuel up to 50% aromatic content resistant NBR rubber.
- Reinforcement: high strength syntetic textile yarn.
- Cover: black, abrasion, heat, fuels, ozone and marine agents resistant self-extinguishing NBR/CR rubber.
- Surface: smooth extruded.
- According to: **DIN 73379, type 2A**



Codice Part Number	Diametro Interno Inside Diameter			Ø Esterno O.D.	Pr. Esercizio Max WP	Pr. Scoppio Burst Pr.	Raggio Curv. Bend Radius	Peso Weight	Lunghezza Length
	DN	Inch.	mm						
100 020 409	4	1/6"	4	9	10	30	30	0,080	25 - 50
100 020 512	5	3/16"	5	12	10	30	35	0,110	25 - 50
100 020 613	6	1/4"	6	13	10	30	40	0,150	25 - 50
100 020 713	7	5/18"	7	13	10	30	45	0,130	25 - 50
100 020 815	8	5/16"	7,5	14,5	10	30	50	0,170	25 - 50
100 021 217	10	3/8"	10	17	10	30	60	0,220	50



IMPIEGO

Tubo monoestruso in PVC flessibile colore verde trasparente, liscio. Impiego: passaggio di gasolio ed altri idrocarburi.

- Temperatura: -10° C +60° C

STRUTTURA

- Trafilato: tubo monoestruso in PVC verde trasparente resistente a gasolio ed altri idrocarburi.
- Superficie: liscia estrusa.

APPLICATION

Smooth flexible trasparent green coloured PVC monoextruded hose. Use: gasoline and other hydrocarbon transiting.

- Temperature range: -10° C +60° C

CONSTRUCTION

- Tube: one-layer, gasoline and other hydrocarbon resistant green transparent PVC.
- Surface: smooth extruded.



Codice Part Number	Diametro Interno Inside Diameter			Ø Esterno O.D. mm.	Lunghezza Lenght mt.
	DN	Inch.	mm		
100 120 407	4	1/6"	4	7	25 - 200
100 120 509	5	3/16"	5	9	25 - 200
100 120 610	6	1/4"	6	10	25 - 200
100 120 712	7	5/18"	7	12	25 - 200



⚠ Taglio a misura applicato sovrapprezzo di 15,00 euro / Cut To Size Applied Supplement of 15 Euro



IMPIEGO

Tubo in gomma cord idoneo per adduzione di olii minerali, diesel e benzine ecologiche.

- Temperatura: -25° C +80° C

STRUTTURA

- Sottostrato: liscio in gomma nera NBR resistente ai prodotti petroliferi con contenuto aromatico non superiore al 50%.
- Rinforzi: tessuti sintetici ad alta resistenza e **cordicella di rame antistatica**.
- Copertura: in gomma nera NBR/CR resistente all'abrasione, ai carburanti, agli olii e agli agenti atmosferici.
- Superficie: liscia ad impressione tela.

Disponibile su richiesta:
rivestimento in calza di acciaio zincato.

APPLICATION

Softwall rubber hose suitable for loading of mineral oils, diesel and unleaded fuel.

- Temperature range: -25° C +80° C

CONSTRUCTION

- Tube: black, smooth, petroleum products up to 50% aromatic content resistant NBR rubber.
- Reinforcement: high strength synthetic textile plies and **anti-static copper wire**.
- Cover: black, abrasion, fuels, oils, and weathering resistant NBR/CR rubber
- Surface: smooth fabric finished.

Available on request:
galvanized steel wire braided cover.



Codice Part Number	Diametro Interno Inside Diameter			Ø Esterno O.D. mm.	Pr. Esercizio Max WP bar	Pr. Scoppio Burst Pr. bar	Peso Weight Kg./mt.	Lunghezza Lenght mt.
	DN	Inch.	mm					
• 100 052 535	25	1"	25	35	10	30	0,700	40
• 100 053 041	30	1.3/16"	30	41	10	30	0,800	40
• 100 053 243	32	1.1/4"	32	43	10	30	0,850	40
• 100 053 546	35	1.3/8"	35	46	10	30	0,930	40
• 100 053 849	38	1.1/2"	38	49	10	30	0,970	40
• 100 054 051	40	1.9/16"	40	51	10	30	1,050	40
• 100 054 253	42	1.21/32"	42	53	10	30	1,150	40
• 100 054 557	45	1.3/4"	45	57	10	30	1,200	40
• 100 055 062	50	2"	50/51	62	10	30	1,350	40
• 100 056 072	60	2.3/8"	60	72	10	30	1,700	40

• Fornibile in 7 gg lavorativi / Available in 7 working days



IMPIEGO

Tubo in gomma utilizzato nelle **pompe di rifornimento carburante** idoneo per erogazione di benzina, etanolo, benzina senza piombo e gasolio.

- Temperatura: -40°C +120°C

STRUTTURA

- Sottostrato: gomma sintetica resistente a benzina, gasolio e carburante senza soluzione di continuità
- Rinforzi: treccia di poliestere ad alta resistenza e **cordicella di rame antistatica**.
- Copertura: in gomma sintetica resistente all'abrasione, ai carburanti, agli olii, agli agenti atmosferici e all'ozono.
- Normativa: EN 1360 TYPE 1

APPLICATION

Rubber hose used in the **fuel stations** suitable for dispensing gasoline, ethanol, unleaded petrol and diesel oil.

- Temperature range: -40°C +120°C

CONSTRUCTION

- Tube: petrol, gasoline and fuel seamless resistant synthetic rubber.
- Reinforcement: high tensile polyester braid and **antistatic copper line**.
- Cover: oil, weather, ozone, abrasion resistant synthetic rubber.
- According to: EN 1360 TYPE 1

Codice Part Number	Diametro Interno Inside Diameter		Ø Esterno O.D.	Pr. Esercizio Max WP	Pr. Scoppio Burst Pr.	Raggio Curv. Bend Radius	Peso Weight	Lunghezza Length
	DN	Inch. mm						
100 751 626	16	5/8" 16,0	26	16	48	0,160	0,420	20 - 60
100 751 930	19	3/4" 19,0	31	16	48	0,190	0,480	25 - 50
100 752 537	25	1" 25	36,5	16	48	0,254	0,690	25 - 50



⚠ Taglio a misura applicato sovrapprezzo di 15,00 euro / Cut To Size Applied Supplement of 15 Euro



IMPIEGO

Tubo per aspirazione e mandata oli per uso idraulico e oli carburante, blue diesel, urea (ISO 22241).

Specifico per cisterne trasporto carburante.

- Temperatura: -25° C +55° C

STRUTTURA

- Sottostrato: tubo in miscela termoplastica a base di **PVC, PU, GOMMA NITRILICA**.
- Rinforzi: spirale in acciaio incorporata e rinforzo in fibra poliestere. **Dal Ø 76 al 152 con treccia in rame per la resa antistatica, previa messa a terra.**
- Copertura: liscia con ottima resistenza all'abrasione da trascinamento.
- Normative: ISO 4649

APPLICATION

Hose for suction and delivery of hydraulic oils and fuels, blue diesel, urea (ISO 22241).

Specific for transport fuel tanks.

- Temperature range: -25° C +55° C

CONSTRUCTION

- Tube: thermoplastic **PVC – PU – NITRILE RUBBER** compound.
- Reinforcement: embedded steel spiral and polyester yarn. **Diameters from 76 to 152 with copper wire for an anti-static rendering, after earthing.**
- Cover: smooth with optimum resistance to abrasion caused by entrainment.
- According to: ISO 4649

Codice Part Number	Diametro Interno Inside Diameter		Spessore Thickness	Pr. Esercizio Max WP	Pr. Scoppio Burst Pr.	Sottovuoto Vacuum	Raggio Curv. Bend Radius	Peso Weight	Lunghezza Length
	Inch.	mm							
• 101 071 928	3/4"	19	4,5	16	48	9	70	0,450	60
• 101 072 535	1"	25	5,3	16	48	9	80	0,670	60
• 101 073 242	1.1/4"	32	5,3	16	48	9	100	0,800	60
• 101 073 548	1.3/8"	35	6,5	14	42	9	120	1,050	60
• 101 073 851	1.1/2"	38	6,5	14	42	9	125	1,200	40
• 101 074 053	1.9/16"	40	6,5	14	42	9	130	1,200	40
• 101 074 558	1.3/4"	45	6,5	12	36	9	140	1,340	40
• 101 075 063	2"	50	6,5	12	36	9	150	1,730	40
• 101 076 074	2.3/8"	60	7	12	36	9	180	1,950	40
• 101 076 377	2.1/2"	63	7	12	36	9	190	2,030	40
• 101 077 690	3"	76	7,25	10	30	9	210	2,700	30
• 101 078 094	3.5/32"	80	7,25	10	30	9	220	2,800	30
• 101 090 106	3.17/32"	90	8	10	30	9	250	3,250	30
• 101 102 117	4"	102	7,75	10	30	9	300	3,700	30

● Fornibile in 7 gg lavorativi / Available in 7 working days



IMPIEGO

Tubo in pvc con spirale pvc molto flessibile idoneo per travaso di olii minerali, carburanti e combustibili industriali.

- Temperatura: -10°C +60°C

STRUTTURA

- Sottostrato: liscio in pvc blu plastificato.
- Rinforzi: spirale di rinforzo in pvc rigido antiurto color bianco.
- Copertura: in pvc blu plastificato resistente agli olii, carburanti e a gran parte dei prodotti chimici.
- Superficie: liscia.

APPLICATION

Pvc wire pvc hose very flexible suitable for discharge of mineral oils and fuels.

- Temperature range: -10°C +60°C

CONSTRUCTION

- Tube: smooth blue pvc.
- Reinforcement: impact and crush resistant white pvc wire helix.
- Cover: oils, fuels and most chemicals resistant blue pvc.
- Surface: smooth.



Codice Part Number	Diametro Interno Inside Diameter		Spessore Thickness	Pr. Esercizio Max WP	Raggio Curv. Bend Radius	Aspirazione Vacuum	Peso Weight	Lunghezza Length
	Inch.	mm						
100 081 927	3/4"	19	4	8	120	0,9	0,430	50
100 082 533	1"	25	4	7	150	0,9	0,550	50
100 083 039	1.3/16"	30	4,5	7	180	0,9	0,680	50
100 084 049	1.9/16"	40	4,5	7	240	0,9	0,850	50
100 084 556	1.3/4"	45	5,5	6	270	0,9	1,000	50
100 085 061	2"	50/51	5,5	6	300	0,9	1,200	50
100 086 072	2.3/8"	60	6	6	360	0,9	1,600	50
100 087 083	2.3/4"	70	6,5	5	420	0,9	1,900	50
100 088 093	3.5/32"	80	6,5	5	480	0,9	2,200	30
100 089 104	3.17/32"	90	7	4	630	0,9	2,700	30
100 081 115	4"	100/102	7,5	4	700	0,9	3,300	30

● Fornibile in 7 gg lavorativi / Available in 7 working days



IMPIEGO

Tubo in gomma tracciato in cotone idoneo per mandata di olii minerali, lubrificanti, carburanti, benzine ecologiche e acqua emulsionata di raffreddamento. Impiegato sui motori a combustione interna.

- Temperatura: -20° C +100° C

STRUTTURA

- Sottostrato: liscio in gomma nera NBR resistente a prodotti petroliferi con un contenuto aromatico non superiore del 50%.
- Rinforzi/Copertura: **treccia di filato di cotone nero** vulcanizzata e impregnata con soluzione di neoprene, che rende il tubo autoestinguente e antiputrescibile.
- Superficie: **trecciata**.

Disponibile su richiesta:

rivestimento in calza acciaio zincato; rivestimento in calza acciaio inox.

APPLICATION

Cotton braided rubber hose suitable for delivery of mineral oils, lubricants, unleaded fuel and common cooling liquids. Used for internal combustion engines.

- Temperature range: -20° C +100° C

CONSTRUCTION

- Tube: black ,smooth, petroleum products up to 50% aromatic content resistant NBR rubber.
- Reinforcement/cover: **braided black cotton** thread and dipped in a neoprene self-extinguishing solution.
- Surface: **braided**.

Available on request:

galvanized steel wire braid cover; stainless steel wire braid cover.



Codice Part Number	Diametro Interno Inside Diameter			Ø Esterno O.D.	Pr. Esercizio Max WP	Pr. Scoppio Burst Pr.	Raggio Curv. Bend Radius	Peso Weight	Lunghezza Length
	DN	Inch.	mm						
100 100 307	3	1/8"	3	7	10	30	25	0,040	25 - 50
100 100 408	4	1/6"	4	8	10	30	35	0,050	25 - 50
100 100 510	5	3/16"	5	10	10	30	40	0,080	25 - 50
100 100 613	6	1/4"	6	13	10	30	50	0,140	25 - 50
100 100 713	7	5/18"	7	13	10	30	55	0,130	25 - 50
100 100 714	8	5/16"	7,5	14,5	10	30	60	0,160	25 - 50
100 100 813	8	5/16"	8	13	10	30	65	0,110	25 - 50
100 100 815	8	5/16"	8	15	10	30	65	0,160	50
100 101 017	10	3/8"	10	17	10	30	80	0,190	25 - 50
100 101 320	12	1/2"	13	20	10	30	130	0,240	50
100 101 623	16	5/8"	16	23	10	30	160	0,280	50
100 101 927	19	3/4"	19	27	10	30	190	0,380	50
100 102 533	25	1"	25	33	10	30	250	0,500	50

● Fornibile in 7 gg lavorativi / Available in 7 working days

▲ Taglio a misura applicato sovrapprezzo di 15,00 euro / Cut To Size Applied Supplement of 15 Euro



IMPIEGO

Tubo spiralato ondulato, flessibile e leggero, **utilizzato nei camion cisterna**. Idoneo per aspirazione e mandata di prodotti petroliferi con contenuto aromatico fino al 50%.

- Temperatura: -20° C +70° C

STRUTTURA

- Sottostrato: nero, liscio, in gomma sintetica antistatica.
- Rinforzo: tessuti sintetici ad alta resistenza e spirale d'acciaio incorporata.
- Copertura: ondulata (ad impressione tela), in gomma sintetica resistente agli oli, ai carburanti ed agli agenti atmosferici.

APPLICATION

hardwall corrugated hose which is flexible and lightweight to be **used on tank trucks** for the suction and discharge of a wide range of petroleum products with up to 50% aromatic content.

- Temperature range: -20° C +70° C

CONSTRUCTION

- Tube: black, smooth, antistatic, synthetic rubber.
- Reinforcement: high strength synthetic cord and steel helix wire.
- Cover: corrugated (wrapped finish), synthetic rubber, oil, fuel, and weathering resistant.



Codice Part Number	Diametro Interno Inside Diameter			Ø Esterno O.D.	Pr. Esercizio Max WP bar	Pr. Scoppio Burst Pr. bar	Raggio Curv. Bend Radius mm.	Peso Weight Kg./mt.	Lunghezza Length mt.
	DN	Inch.	mm						
100 115 061	50	1.31/32"	50	63	6	18	125	1,520	40
100 118 095	80	3.5/32"	80	95	4	12	200	2,500	20 - 40
100 111 116	100	3.15/16"	100	119	4	12	250	3,080	20



● Fornibile in 7 gg lavorativi / Available in 7 working days

MANICOTTI LISCI ALLE ESTREMITÀ - SOFT END



IMPIEGO

Tubo spiralato ondulato, flessibile e leggero, **utilizzato nei camion cisterna**. Idoneo per aspirazione e mandata di prodotti petroliferi con contenuto aromatico fino al 50%.

- Temperatura: -20° C +70° C

STRUTTURA

- Sottostrato: nero, liscio, in gomma sintetica antistatica.
- Rinforzo: tessuti sintetici ad alta resistenza e spirale d'acciaio incorporata.
- Copertura: ondulata (ad impressione tela), in gomma sintetica resistente agli oli, ai carburanti ed agli agenti atmosferici.

Confezione: **fornito a misura fissa con manicotti lisci alle 2 estremità.**

APPLICATION

Hardwall corrugated hose which is flexible and lightweight to be **used on tank trucks** for the suction and discharge of a wide range of petroleum products with up to 50% aromatic content.

- Temperature range: -20° C +70° C

CONSTRUCTION

- Tube: black, smooth, antistatic, synthetic rubber.
- Reinforcement: high strength synthetic cord and steel helix wire.
- Cover: corrugated (wrapped finish), synthetic rubber, oil, fuel, and weathering resistant.

Packaging: **supplied in fixed measure with soft end.**



Codice Part Number	Diametro Interno Inside Diameter			Ø Esterno O.D.	Pr. Esercizio Max WP bar	Pr. Scoppio Burst Pr. bar	Raggio Curv. Bend Radius mm.	Peso Weight Kg./mt.	Lunghezza Length mt.
	DN	Inch.	mm						
101 118 095	80	3.5/32"	80	95	4	12	200	6,25	2,5
102 118 095	80	3.5/32"	80	95	4	12	200	8,75	3,5
103 118 095	80	3.5/32"	80	95	4	12	200	10,00	4
132 118 095	80	3.5/32"	80	95	4	12	200	12,00	4,8
104 118 095	80	3.5/32"	80	95	4	12	200	12,50	5



● Fornibile in 7 gg lavorativi / Available in 7 working days



TUBI SETTORE INDUSTRIALE
INDUSTRIAL SECTION HOSES

TUBI PER ACQUA E FLUIDI NON CORROSIVI
WATER & NON CORROSIVE FLUIDS HOSES



IMPIEGO

Tubo in gomma cord idoneo per mandata di acqua, liquidi non corrosivi, aria.

- Temperatura: -30° C +80° C

STRUTTURA

- Sottostrato: liscio in gomma nera SBR.
- Rinforzi: **tessuti sintetici** ad alta resistenza.
- Copertura: in gomma nera SBR/EPDM resistente all'abrasione e agli agenti atmosferici.
- Superficie: liscia ad impressione tela.

APPLICATION

Softwall rubber hose suitable for delivery of water and non corrosive fluids.

- Temperature range: -30° C +80° C

CONSTRUCTION

- Tube: black, smooth SBR rubber.
- Reinforcement: high strength **synthetic textile plies**.
- Cover: black, abrasion and weathering resistant SBR/EPDM rubber.
- Surface: smooth fabric finished.



Codice Part Number	Diametro Interno Inside Diameter			Ø Esterno O.D.		Pr. Esercizio Max WP	Pr. Scoppio Burst Pr.	Peso Weight	Lunghezza Length
	DN	Inch.	mm	mm.	mm.				
• 100 132 534	25	1"	25	34	34	10	30	0,63	40
• 100 133 042	30	1.3/16"	30	42	42	10	30	0,98	40
• 100 133 244	32	1.1/4"	32	44	44	10	30	1,03	40
• 100 133 547	35	1.3/8"	35	47	47	10	30	1,23	40
• 100 133 852	38	1.1/2"	38	52	52	10	30	1,42	40
• 100 134 054	40	1.9/16"	40	54	54	10	30	1,48	40
• 100 134 561	45	1.3/4"	45	61	61	10	30	1,88	40
• 100 135 168	50	2"	51	68	68	10	30	2,19	40
• 100 136 082	60	2.3/8"	60	82	82	10	30	3,28	40
• 100 138 103	80	3.5/32"	80	103	103	9	27	4,65	20
• 100 131 126	100	4"	102	126	126	8	24	6,24	20

• Fornibile in 7 gg lavorativi / Available in 7 working days

APPIATTIBILE - FLAT



IMPIEGO

Tubo in gomma cord leggero ed **appiattibile** idoneo per scarico di acque sporche e industriali.

- Temperatura: -30° C +80° C

STRUTTURA

- Sottostrato: liscio in gomma nera SBR.
- Rinforzi: **tessuti sintetici** ad alta resistenza.
- Copertura: in gomma nera SBR/EPDM resistente all'abrasione e agli agenti atmosferici.
- Superficie: liscia ad impressione tela.

APPLICATION

Softwall light and **flat rubber** hose suitable for discharge of industrial and waste water.

- Temperature range: -30° C +80° C

CONSTRUCTION

- Tube: black, smooth SBR rubber.
- Reinforcement: high **strength synthetic textile plies**.
- Cover: black, abrasion and weathering resistant SBR/EPDM rubber.
- Surface: smooth fabric finished.



Codice Part Number	Diametro Interno Inside Diameter			Ø Esterno O.D.		Pr. Esercizio Max WP	Pr. Scoppio Burst Pr.	Peso Weight	Lunghezza Length
	DN	Inch.	mm	mm.	mm.				
• 100 143 036	30	1.3/16"	30	36	36	10	30	0,36	40
• 100 143 238	32	1.1/4"	32	38	38	10	30	0,41	40
• 100 143 844	38	1.1/2"	38	44	44	10	30	0,48	40
• 100 144 046	40	1.9/16"	40	46	46	10	30	0,50	40
• 100 144 551	45	1.3/4"	45	51	51	10	30	0,56	40
• 100 145 057	50	2"	50/51	57	57	10	30	0,74	40
• 100 146 067	60	2.3/8"	60	67	67	10	30	0,84	40
• 100 147 077	70	2.3/4"	70	77	77	10	30	0,97	40
• 100 147 582	75	3"	75/76	82	82	10	30	1,03	40
• 100 148 087	80	3.5/32"	80	87	87	10	30	1,10	40
• 100 149 098	90	3.17/32"	90	98	98	10	30	1,45	40
• 100 141 108	100	4"	100/102	108	108	10	30	1,57	40
• 100 141 128	120	4.3/4"	120	128	128	10	30	1,93	20
• 100 141 160	150	6"	152	160	160	10	30	2,70	20
• 100 142 213	200	8"	203	213	213	10	30	4,70	20
• 100 142 264	255	10"	254	264	264	10	30	6,10	20

• Fornibile in 7 gg lavorativi / Available in 7 working days



APPIATTIBILE - FLAT



IMPIEGO

Tubo in **gomma** cord per mandata acqua, fertilizzanti e fluidi non corrosivi. Per la sua leggerezza ed **appiattibilità** trova impiego ideali negli impianti mobili d'irrigazione a pioggia e come accessorio di pompe sommerse.

- Temperatura: -30°C +80°C

STRUTTURA

- Sottostrato: liscio in gomma nera EPDM.
- Rinforzi: **tessuti sintetici** ad alta resistenza.
- Copertura: in gomma nera EPDM resistente all'abrasione e agli agenti atmosferici.
- Superficie: liscia ad impressione tela.

APPLICATION

Softwall **rubber** hose suitable for delivery of water, fertilizer and non corrosive fluids. For its lightness and flattened is ideal for use for submersible pumps and irrigation systems.

- Temperature range: -30°C +80°C

CONSTRUCTION

- Tube: black, smooth EPDM rubber.
- Reinforcement: high **strength synthetic textile plies**.
- Cover: black, abrasion and weathering resistant EPDM rubber.
- Surface: smooth fabric finished.

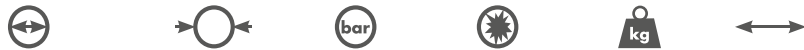

Codice Part Number	Diametro Interno Inside Diameter			Ø Esterno O.D.	Pr. Esercizio Max WP	Pr. Scoppio Burst Pr.	Peso Weight	Lunghezza Lenght
	DN	Inch.	mm					
101 145 060	50	2"	50/51	61	20	60	1,10	20
101 146 069	60	2.3/8"	60	72	20	60	1,49	20
101 148 090	80	3.5/32"	80	92	20	60	1,85	20
101 149 102	90	3.17/32"	90	102	20	60	2,10	20
101 141 113	100	4"	100/102	114	20	60	2,20	20
101 141 131	120	4.3/4"	120	132	20	60	2,50	20
101 141 164	150	6"	152	168	20	60	4,58	20

• Fornibile in 7 gg lavorativi / Available in 7 working days



APPIATTIBILE - FLAT



IMPIEGO

Tubo in **PVC** a struttura **APPIATTIBILE** per mandata a pressione di acqua e liquidi in genere.

- Temperatura: -10°C +60°C

STRUTTURA

- Sottostrato: liscio in **PVC**.
- Rinforzi: **tessuti sintetici** ad alta resistenza.
- Copertura: PVC azzurro resistente all'abrasione e agli agenti atmosferici.
- Superficie: liscia estrusa.

APPLICATION

Softwall light and **flat PVC hose** suitable for delivery of water and liquids.

- Temperature range: -10°C +60°C

CONSTRUCTION

- Tube: black, smooth **PVC**.
- Reinforcement: high strength **synthetic textile plies**.
- Cover: blue, abrasion and weathering resistant PVC.
- Surface: smooth extruded.



Codice Part Number	Diametro Interno Inside Diameter			Ø Esterno O.D.	Pr. Esercizio Max WP	Pr. Scoppio Burst Pr.	Peso Weight	Lunghezza Lenght
	DN	Inch.	mm					
100 812 529	25	1"	25	29	8	24	0,20	50
100 813 034	30	1.3/16"	30	34	8	24	0,22	50
100 813 236	32	1.1/4"	32	36	8	24	0,23	50
100 813 539	35	1.3/8"	35	39	8	24	0,25	50
100 813 842	38	1.1/2"	38	42	8	24	0,27	50
100 814 044	40	1.9/16"	40	44	8	24	0,29	50
100 814 549	45	1.3/4"	45	49	8	24	0,32	50
100 815 054	50	2"	51	54	8	24	0,36	50
100 816 064	60	2.3/8"	60	64	8	24	0,48	50
100 816 367	63	2.1/2"	63.5	67	8	24	0,50	50
100 817 074	70	2.3/4"	70	74	8	24	0,57	50
100 817 680	76	3"	76	80	8	24	0,60	50
100 818 084	80	3.5/32"	80	84	8	24	0,66	50
100 819 094	90	3.17/32"	90	94	8	24	0,76	50
100 811 104	100	4"	102	104	8	24	0,85	50
100 811 131	127	5"	127	131	5.5	17	1,25	50
100 811 156	150	6"	152	156	5.5	17	1,58	50
100 812 207	200	8"	203	207	2.5	8	2,20	50

• Fornibile in 7 gg lavorativi / Available in 7 working days



MANICOTTI LISCI ALLE ESTREMITÀ - SOFT END



IMPIEGO

Tubo in gomma spiralato ondulato idoneo per aspirazione e leggera mandata di acqua e fluidi non corrosivi.

- Temperatura: -35°C +70°C

STRUTTURA

- Sottostrato: liscio in gomma nera SBR.
- Rinforzi: **spirale metallica** incorporata con tessuti sintetici ad alta resistenza.
- Copertura: in gomma nera SBR/EPDM resistente all'abrasione e agli agenti atmosferici.
- Superficie: ondulata ad impressione tela.
- **Manicotti all'estremità**
- Lunghezze finali a richiesta.

APPLICATION

Hardwall corrugated cover rubber hose suitable for suction and light delivery of water and non corrosive fluids.

- Temperature range: -35°C +70°C

CONSTRUCTION

- Tube: black, smooth SBR rubber.
- Reinforcement: **steel wire helix** with high strength synthetic textile plies.
- Cover: black, abrasion and weathering resistant SBR/EPDM rubber.
- Surface: corrugated fabric finished.
- **Soft cuffs at both ends**
- Length on request.



Codice Part Number	Diametro Interno Inside Diameter		Spessore Thickness	Pr. Esercizio Max WP	Pr. Scoppio Burst Pr.	Raggio Curv. Bend Radius	Aspirazione Vacuum	Peso Weight	Lunghezza Length
	Inch.	mm							
100 168 092	3.5/32"	80	6	3	9	320	0,7	2,80	3
100 161 116	4"	102	7	3	9	500	0,7	3,70	3
100 161 127	5"	127	8	3	9	750	0,7	5,30	3
100 161 170	6"	152	9	3	9	950	0,7	7,00	3
106 182 150	6"	203	11	3	9	950	0,7	7,00	6
100 162 225	8"	203	11	3	9	1200	0,7	9,50	3
100 162 278	10"	254	12	3	9	1500	0,7	16,00	multipli 2
100 163 331	12"	305	13	3	9	1900	0,7	18,90	multipli 2

● Fornibile in 7 gg lavorativi / Available in 7 working days



IMPIEGO

Tubo in PVC a struttura **APIATTIBILE** per mandata a pressione di acqua e liquidi in genere.

- Temperatura: -10°C +60°C

STRUTTURA

- Sottostrato: liscio in **PVC**.
- Rinforzi: **tessuti sintetici** ad alta resistenza.
- Copertura: PVC azzurro resistente all'abrasione e agli agenti atmosferici.
- Superficie: liscia estrusa.

APPLICATION

Softwall light and **flat PVC hose** suitable for delivery of water and liquids.

- Temperature range: -10°C +60°C

CONSTRUCTION

- Tube: black, smooth **PVC**.
- Reinforcement: high strength **synthetic textile plies**.
- Cover: blue, abrasion and weathering resistant PVC.
- Surface: smooth extruded.



Codice Part Number	Diametro Interno Inside Diameter		Spessore Thickness	Pr. Esercizio Max WP	Pr. Scoppio Burst Pr.	Raggio Curv. Bend Radius	Aspirazione Vacuum	Peso Weight	Lunghezza Length
	Inch.	mm							
100 172 535	1"	25	35	10	30	150	0,9	0,77	60
100 173 040	1.3/16"	30	40	10	30	180	0,9	0,91	60
100 173 242	1.1/4"	32	42	10	30	190	0,9	0,97	60
100 173 545	1.3/8"	35	45	10	30	210	0,9	1,08	60
100 173 848	1.1/2"	38	48	10	30	230	0,9	1,20	60
100 174 050	1.9/16"	40	50	10	30	240	0,9	1,28	60
100 174 555	1.3/4"	45	55	10	30	270	0,9	1,45	60
100 175 162	2"	51	62	10	30	310	0,9	1,76	60
100 176 072	2.3/8"	60	72	10	30	360	0,9	1,80	20-40
100 177 690	3"	76	90	10	30	460	0,9	2,90	20
100 178 094	3.5/32"	80	94	10	30	480	0,9	3,20	20
100 179 106	3.17/32"	90	106	10	30	540	0,9	3,70	20
100 171 116	4"	102	116	10	30	610	0,9	4,00	20
100 171 145	5"	127	145	10	30	760	0,9	7,00	20
100 171 173	6"	152	173	10	30	920	0,9	10,00	20

● Fornibile in 7 gg lavorativi / Available in 7 working days



IMPIEGO

Tubo in PVC con spirale PVC idoneo per aspirazione e mandata di liquidi nel settore agricolo dove sia richiesta una buona flessibilità. Indicato per spurghi di fognature, pozzi neri e aspirazione liquami su carri botte.

- Temperatura: -25°C +60°C

STRUTTURA

- Sottostrato: liscio in PVC grigio superelastico.
- Rinforzi: **spirale di rinforzo esterna in PVC rigido antiurto e anti schiacciamento color verde** inserita nel PVC superelastico speciale.
- Superficie: semi ondulata

APPLICATION

PVC wire PVC hose suitable for suction and delivery of liquids for heavy duty applications where an extremely flexibility is required. Used on tank cars and irrigation equipments.

- Temperature range: -25°C +60°C

CONSTRUCTION

- Tube: grey smooth superelastic PVC.
- Reinforcement: **rigid external impact and crush resistant green PVC wire** dipped in the special superelastic PVC.
- Surface: lightly corrugated.



Codice Part Number	Diametro Interno Inside Diameter		Spessore Thickness mm.	Pr. Esercizio Max WP bar	Pr. Scoppio Burst Pr. bar	Raggio Curv. Bend Radius mm.	Aspirazione Vacuum bar	Peso Weight Kg./mt.	Lunghezza Length mt.
	Inch.	mm							
100 185 062	2"	50/51	62	5	15	200	0,8	1,05	50
100 186 072	2.3/8"	60	72	4	12	240	0,8	1,25	50
100 188 094	3.5/32"	80	94	3	9	320	0,8	1,85	30 - 50
100 189 104	3.17/32"	90	100,3	3	9	360	0,9	2,19	30
100 181 116	4"	100/102	116	3	9	400	0,7	2,70	30 - 50
100 181 136	4.3/4"	120	136	2	6	480	0,7	3,60	20
100 181 170	6"	150/152	170	2	6	600	0,7	5,00	20



• Fornibile in 7 gg lavorativi / Available in 7 working days

COLORE NERO - BLACK COLOR



IMPIEGO

Tubo in PVC con spirale PVC idoneo per passaggio di acqua, liquidi, pesticidi e fertilizzanti.

- Temperatura: -25°C +60°C

STRUTTURA

- Sottostrato: liscio in PVC nero superelastico.
- Rinforzi: **spirale in PVC rigido antiurto color bianco**.
- Copertura: in PVC nera resistente all'ozono, agli agenti atmosferici e a gran parte dei prodotti chimici.
- Superficie: liscia **colore NERO**.

APPLICATION

PVC wire PVC hose suitable for delivery of water, liquids, pesticides and fertilizers.

- Temperature range: -25°C +60°C

CONSTRUCTION

- Tube: superelastic smooth black PVC.
- Reinforcement: impact and crush resistant white PVC wire helix.
- Cover: ozone, weathering and most chemicals resistant transparent PVC.
- Surface: smooth **BLACK color**.



Codice Part Number	Diametro Interno Inside Diameter		Spessore Thickness mm.	Pr. Esercizio Max WP bar	Raggio Curv. Bend Radius mm.	Aspirazione Vacuum bar	Peso Weight Kg./mt.	Lunghezza Length mt.
	Inch.	mm						
100 901 924	3/4"	19	3	9	60	0,7	0,30	30
100 902 530	1"	25	3,5	8	75	0,7	0,40	30
100 903 035	1.3/16"	30	3,5	8	90	0,7	0,45	30
100 903 540	1.3/8"	35	4	7	110	0,7	0,56	30
100 904 046	1.9/16"	40	4,25	6	120	0,7	0,60	30
100 905 058	2"	51	4,25	5	150	0,7	0,85	30

• Fornibile in 7 gg lavorativi / Available in 7 working days

▲ Taglio a misura applicato sovrapprezzo di 15,00 euro / Cut To Size Applied Supplement of 15 Euro



TUBI SETTORE INDUSTRIALE
INDUSTRIAL SECTION HOSES

TUBI PER ARIA
AIR HOSES

IDONEO ANCHE PER ACQUA - SUITABLE FOR WATER



IMPIEGO

Tubo in gomma long length idoneo per mandata di acqua, fluidi inerti e aria.

- Temperatura: -30° C +80° C

STRUTTURA

- Sottostrato: liscio in gomma nera SBR.
- Rinforzi: inserzioni di filati sintetici ad alta resistenza.
- Copertura: in gomma nera SBR/EPDM resistente all'abrasione ed agli agenti atmosferici.
- Superficie: liscia estrusa.

APPLICATION

Long length rubber hose suitable for delivery of water, non corrosive fluids and air.

- Temperature range: -30° C +80° C

CONSTRUCTION

- Tube: black, smooth SBR rubber.
- Reinforcement: high strength syntetic textile yarn.
- Cover: black, abrasion and weathering resistant SBR/EPDM rubber.
- Surface: smooth extruded.



Codice Part Number	Diametro Interno Inside Diameter			Ø Esterno O.D.	Pr. Esercizio Max WP	Pr. Scoppio Burst Pr.	Raggio Curv. Bend Radius	Peso Weight	Lunghezza Lenght
	DN	Inch.	mm						
100 350 815	8	5/16"	8	15	10	30	65	0,18	25 - 100
100 351 017	10	3/8"	10	17	10	30	80	0,21	25 - 100
100 351 217	11	15/32"	12	17	10	30	95	0,17	25 - 100
100 351 319	12	1/2"	13	19	10	30	105	0,22	25 - 100
100 351 521	15	19/32"	15	21	10	30	120	0,25	25 - 100
100 351 623	16	5/8"	16	23	10	30	130	0,31	20 - 80
100 351 926	19	3/4"	19	26	10	30	150	0,36	25 - 50
100 352 030	20	25/32"	20	30	10	30	160	0,57	25 - 50
100 352 230	22	7/8"	22	30	10	30	175	0,48	25 - 50
100 352 533	25	1"	25	33	10	30	200	0,53	25 - 50

⚠ Taglio a misura applicato sovrapprezzo di 15,00 euro / Cut To Size Applied Supplement of 15 Euro

IDONEO ANCHE PER ACQUA - SUITABLE FOR WATER



IMPIEGO

Tubo in gomma long length idoneo per mandata di aria compressa e fluidi inerti.

- Temperatura: -30° C +80° C

STRUTTURA

- Sottostrato: liscio in gomma nera SBR.
- Rinforzi: inserzioni di filati sintetici ad alta resistenza.
- Copertura: in gomma nera SBR/EPDM resistente all'abrasione e agli agenti atmosferici.
- Superficie: liscia estrusa.

APPLICATION

Long length rubber hose suitable for delivery of compressed air and non corrosive fluids.

- Temperature range: -30° C +80° C

CONSTRUCTION

- Tube: black, smooth SBR rubber.
- Reinforcement: high strength syntetic textile yarn.
- Cover: black, abrasion and weathering resistant SBR/EPDM rubber.
- Surface: smooth extruded.



Codice Part Number	Diametro Interno Inside Diameter			Ø Esterno O.D.	Pr. Esercizio Max WP	Pr. Scoppio Burst Pr.	Raggio Curv. Bend Radius	Peso Weight	Lunghezza Lenght
	DN	Inch.	mm						
100 360 614	6	1/4"	6	14	20	60	40	0,15	25 - 100
100 360 817	8	5/16"	8	17	20	60	55	0,22	25 - 100
100 361 019	10	3/8"	10	19	20	60	70	0,25	25 - 100
100 361 323	12	1/2"	13	23	20	60	90	0,34	25 - 100
100 361 626	16	5/8"	16	26	20	60	110	0,40	20 - 80
100 361 930	19	3/4"	19	30	20	60	135	0,51	25 - 50
100 362 537	25	1"	25	37	20	60	175	0,88	25 - 50

⚠ Taglio a misura applicato sovrapprezzo di 15,00 euro / Cut To Size Applied Supplement of 15 Euro

IDONEO PER AVVOLGITORI - SUITABLE FOR REELS



IMPIEGO

Tubo flessibile retinato in poliuretano per utensili pneumatici in genere, verniciatura, aerografi, ecc.

- Temperatura: -20°C +65°C

STRUTTURA

- Sottostrato: liscio in **poliuretano trasparente**.
- Rinforzi: inserzione di filati sintetici ad alta resistenza.
- Copertura: in **poliuretano blu** resistente all'abrasione, agli agenti chimici e a gran parte dei prodotti chimici.
- Superficie: liscia estrusa.

APPLICATION

Polyurethane flexible hose for tools, painting, spray-guns, etc.

- Temperature range: -20°C +65°C

CONSTRUCTION

- Tube: smooth transparent polyurethane.
- Reinforcement: high strength synthetic textile yarn.
- Cover: abrasion, weathering and most chemicals resistant **blue polyurethane**.
- Surface: smooth extruded.



Codice Part Number	Diametro Interno Inside Diameter			Ø Esterno O.D.		Pr. Esercizio Max WP	Pr. Scoppio Burst Pr.	Peso Weight	Lunghezza Lenght
	DN	Inch.	mm	mm.	mm.				
100 810 610	6	1/4"	6	10	20	60	0,065	100	
100 810 812	8	5/16"	8	12	20	60	0,085	100	
100 811 015	10	3/8"	10	15	20	60	0,130	100	
100 811 319	12	1/2"	13	19	20	60	0,195	100	



• Fornibile in 7 gg lavorativi / Available in 7 working days



IMPIEGO

Tubo in gomma cord idoneo per aria compressa per **impieghi gravosi**.

- Temperatura: -30°C +80°C

STRUTTURA

- Sottostrato: liscio in gomma nera SBR resistente a tracce di olii nebulizzati.
- Rinforzi: tessuti sintetici ad alta resistenza.
- Copertura: in gomma nera SBR/EPDM resistente all'abrasione e agli agenti atmosferici.
- Superficie: liscia ad impressione tela.

APPLICATION

Softwall rubber hose **heavy duty** air compressed delivery.

- Temperature range: -30°C +80°C

CONSTRUCTION

- Tube: black, smooth SBR rubber oil mist resistant.
- Reinforcement: high strength synthetic textile plies.
- Cover: black, abrasion and weathering resistant SBR/ EPDM rubber.
- Surface: smooth fabric finished.



Codice Part Number	Diametro Interno Inside Diameter			Ø Esterno O.D.		Pr. Esercizio Max WP	Pr. Scoppio Burst Pr.	Peso Weight	Lunghezza Lenght
	DN	Inch.	mm	mm.	mm.				
100 371 323	13	1/2"	13	23	20	60	0,34	40	
100 381 932	19	3/4"	19	32	25	75	0,71	50	
100 382 539	25	1"	25	39	25	75	0,94	50	
100 383 248	32	1.1/4"	32	48	25	75	1,43	40	
100 383 854	38	1.1/2"	38	54	25	75	1,65	40	
100 385 169	50	2"	51	69	25	75	2,45	40	
100 386 083	60	2.3/8"	60	83	25	75	3,40	40	



• Fornibile in 7 gg lavorativi / Available in 7 working days



IMPIEGO

Tubo appiattibile particolarmente leggero per mandata di aria compressa, resistente alle tracce di olio nebulizzato.

- Temperatura: -20°C +80°C

STRUTTURA

- Sottostrato: **giallo** liscio in **gomma** nitrilica.
- Rinforzi: inserzioni tessili ad alta tenacità.
- Copertura: gomma sintetica resistente alle intemperie, all'ozono ed all'abrasione.
- Superficie: **gialla liscia con nervatura longitudinale**.

APPLICATION

Light weight, **layflat** compressed air hose, oil mist resistant.

- Temperature range: -20°C +80°C

CONSTRUCTION

- Tube: **yellow** nitrile **rubber** tube.
- Reinforcement: high strength textile.
- Cover: synthetic rubber weather, ozone and abrasion resistant.
- Surface: **smooth ribbed yellow**.



Codice Part Number	Diametro Interno Inside Diameter			Pr. Esercizio Max WP	Pr. Scoppio Burst Pr.	Peso Weight	Lunghezza Lenght
	DN	Inch.	mm				
100 381 900	19	3/4"	19	20	75	0,15	40
100 382 500	25	1"	25	20	75	0,21	40
100 383 800	38	1.1/2"	38	20	60	0,44	40
100 385 100	50	2"	51	20	51	0,65	40



● Fornibile in 7 gg lavorativi / Available in 7 working days



IMPIEGO

Tubo per impianti di aspirazione fumi gas automezzi sia a pavimento che sospesi su arrotolatori.

Tubo in gomma termoplastica con spirale che ritorna dopo lo schiacciamento.

- Temperatura: -40°C +150°C con punte di utilizzo fino a +170°C.

A richiesta Temperature d'impiego: -40°C +200°C.

STRUTTURA

- Tubo: superficie interna liscia. Leggero e flessibile. Tubo in gomma termoplastica che ritorna dopo lo schiacciamento.
- Superficie: resistente al calore, all'invecchiamento e agli agenti atmosferici.

APPLICATION

Developed as an extraction hose for exhaust fumes and gases, especially suitable for hose-reels.

Thermoplastic rubber hose with embedded spiral allowing the hose to be run over by vehicles.

- Temperature range: -40°C +150°C briefly up to 170°C.

On request temperature range: -40°C +200°C.

CONSTRUCTION

- Tube: smooth bore. Light and flexible. Thermoplastic rubber hose with embedded spiral allowing the hose to be run over by vehicles
- Surface: resistant to heat, ageing and atmospheric agents.
- Surface: smooth fabric finished.



Codice Part Number	Diametro Interno Inside Diameter			Ø Esterno O.D.	Raggio Curv. Bend Radius	Aspirazione Vacuum	Peso Weight	Lunghezza Lenght
	Inch.	mm	mm.					
100 435 000	2"	52	68	120	5	0,520	20	
100 436 000	2.3/8"	64	80	150	3,5	0,630	20	
100 437 500	3"	75	90	180	1,5	0,750	20	
100 431 000	4"	103	120	230	1	1,000	20	
100 431 250	5"	128	145	280	0,8	1,250	20	
100 431 500	6"	153	172	330	0,6	1,500	20	
100 432 000	8"	205	224	440	0,5	1,950	20	



● Fornibile in 7 gg lavorativi / Available in 7 working days



IMPIEGO

Tubo in **PVC** con spirale in acciaio idoneo per aspirazione di aria, gas, vapori e fumi chimicamente aggressivi.

La speciale struttura consente l'impiego in tutte le installazioni di aspirazione e ventilazione dell'aria anche con parti in movimento. Condizionamento navale e civile.

Tubo anti-inflammabile secondo classificazione UNI 8456/87, UNI 9174/87, UNI 9174/A1/96.

- Temperatura: -25°C +105°C (Punte 120°C)

STRUTTURA

- Sottostrato: **tessuto grigio chiaro in fibra di vetro spalmato di PVC.**
- Rinforzi: **spirale in acciaio.**
- Copertura: tessuto grigio chiaro in fibra di vetro spalmato di PVC.
- **Comprimibilità : 8:1.**

APPLICATION

Steel wire **PVC** hose suitable for air, gas, fumes, steam suction. Ship and domestic conditioning. The special manufacturing allows the hose to be used in all air suction installation and ventilation, also connecting moving components.

Fire resistance class UNI 8456/87, UNI 9174/87, UNI 9174/A1/96.

- Temperature range: -25°C + 105°C (Peaks 120°C)

CONSTRUCTION

- Tube: **fibreglass fabric coated grey PVC.**
- Reinforcement: **steel wire helix.**
- Cover: fibreglass fabric coated grey PVC.
- **Compressing: 8:1.**



Codice Part Number	Diametro Interno Inside Diameter		Pr. Esercizio Max WP	Raggio Curv. Bend Radius	Aspirazione Vacuum	Peso Weight	Lunghezza Lenght
	Inch.	mm					
• 100 404 046	1.9/16"	40	0,70	20	0,18	0,120	10
• 100 405 056	2"	51	0,70	25	0,18	0,125	10
• 100 406 066	2.3/8"	60	0,70	30	0,13	0,150	10
• 100 407 076	2.3/4"	70	0,60	35	0,13	0,170	10
• 100 407 682	3"	76	0,50	38	0,09	0,180	10
• 100 408 086	3.5/32"	80	0,50	40	0,09	0,200	10
• 100 401 096	3.17/32"	90	0,40	45	0,08	0,220	10
• 100 401 106	4"	102	0,40	50	0,08	0,260	10
• 100 401 116	4.3/6"	110	0,40	55	0,08	0,280	10
• 100 401 126	4.3/4"	120	0,40	60	0,07	0,300	10
• 100 401 131	5"	127	0,30	62	0,07	0,310	10
• 100 401 136	5.1/8"	130	0,30	65	0,06	0,330	10

SEGUE A PAG. 95 / Follow to pag. 95



IMPIEGO

Tubo in **PVC** con spirale in acciaio idoneo per aspirazione di aria, gas, vapori e fumi chimicamente aggressivi.

La speciale struttura consente l'impiego in tutte le installazioni di aspirazione e ventilazione dell'aria anche con parti in movimento. Condizionamento navale e civile.

Tubo anti-inflammabile secondo classificazione UNI 8456/87, UNI 9174/87, UNI 9174/A1/96.

- Temperatura: -25°C +105°C (Punte 120°C)

STRUTTURA

- Sottostrato: **tessuto grigio chiaro in fibra di vetro spalmato di PVC.**
- Rinforzi: **spirale in acciaio.**
- Copertura: tessuto grigio chiaro in fibra di vetro spalmato di PVC.
- **Comprimibilità: 8:1.**

APPLICATION

Steel wire **PVC** hose suitable for air, gas, fumes, steam suction. Ship and domestic conditioning. The special manufacturing allows the hose to be used in all air suction installation and ventilation, also connecting moving components.

Fire resistance class UNI 8456/87, UNI 9174/87, UNI 9174/A1/96.

- Temperature range: -25°C + 105°C (Peaks 120°C)

CONSTRUCTION

- Tube: **fibreglass fabric coated grey PVC.**
- Reinforcement: **steel wire helix.**
- Cover: fibreglass fabric coated grey PVC.
- **Compressing: 8:1.**



Codice Part Number	Diametro Interno Inside Diameter		Pr. Esercizio Max WP	Raggio Curv. Bend Radius	Aspirazione Vacuum	Peso Weight	Lunghezza Lenght
	Inch.	mm					
• 100 401 146	5.1/2"	140	0,20	75	0,06	0,360	10
• 100 401 156	6"	152	0,20	80	0,05	0,400	10
• 100 401 166	6.5/16"	160	0,15	90	0,05	0,430	10
• 100 401 186	7.1/8"	180	0,15	100	0,04	0,570	10
• 100 402 206	8"	203	0,15	110	0,04	0,640	10
• 100 402 256	10"	254	0,08	125	0,03	0,780	10
• 100 403 306	12"	305	0,06	150	0,02	1,090	10
• 100 403 356	14"	355	0,03	175	0,02	1,200	10
• 100 404 406	16"	406	0,02	200	0,01	1,300	10



TUBI SETTORE INDUSTRIALE
INDUSTRIAL SECTION HOSES

TUBI PER ACQUA CALDA E VAPORE
HOT WATER & STEAM HOSES



ROLOI INTERI - WHOLE ROLLS



IMPIEGO

Tubo in gomma cord idoneo per passaggio di acqua calda mista a liquidi antigelo.

- Temperatura: -40°C +120°C

STRUTTURA

- Sottostrato: liscio in gomma nera EPDM resistente al calore.
- Rinforzi: tessuti sintetici ad alta resistenza.
- Copertura: in gomma nera EPDM resistente all'abrasione ad calore e all'invecchiamento.
- Superficie: liscia ad impressione tela.
- Normativa: DIN 73411-79.

APPLICATION

Softwall rubber hose suitable for conveying hot water mixed with cooling liquids.

- Temperature range: -40°C +120°C

CONSTRUCTION

- Tube: black, smooth, heat resistant EPDM rubber.
- Reinforcement: high strength synthetic textile plies.
- Cover: black, abrasion, heat and ageing resistant EPDM rubber.
- Surface: smooth fabric finished.
- According to: DIN 73411-79.



Codice Part Number	Diametro Interno Inside Diameter			Ø Esterno O.D. mm.	Pr. Esercizio Max WP bar	Pr. Scoppio Burst Pr. bar	Peso Weight Kg./mt.	Lunghezza Length mt.
	DN	Inch.	mm					
100 251 824	18	23/32"	18	24	4	12	0,28	20
100 251 925	19	3/4"	19	25	4	12	0,29	20
100 252 026	20	25/32"	20	26	4	12	0,30	20
100 252 228	22	7/8"	22	28	4	12	0,33	20
100 252 532	25	1"	25	32	4	12	0,42	20
100 252 836	28	1.3/32"	28	36	4	12	0,46	20
100 253 038	30	1.3/16"	30	38	4	12	0,58	20
100 253 240	32	1.1/4"	32	40	4	12	0,62	20
100 253 543	35	1.3/8"	35	43	4	12	0,67	20
100 253 846	38	1.1/2"	38	46	4	12	0,82	20
100 254 049	40	1.9/16"	40	49	4	12	0,86	20
100 254 251	42	1.21/32"	42	51	4	12	0,90	20
100 254 554	45	1.3/4"	45	54	4	12	1,02	20
100 255 060	50	1.31/32"	50	60	4	12	1,13	20
100 255 565	55	2.5/32"	55	65	4	12	1,32	20
100 256 070	60	2.3/8"	60	70	4	12	1,43	20
100 256 576	65	2.9/16"	65	76	4	12	1,51	20
100 257 081	70	2.3/4"	70	81	4	12	1,75	20
100 257 586	75	2.15/16"	75	86	4	12	1,80	20
100 258 092	80	3.5/32"	80	92	4	12	2,16	20
100 259 102	90	3.17/32"	90	102	4	12	2,41	20
100 251 113	100	3.15/16"	100	113	4	12	2,80	20

● Fornibile in 7 gg lavorativi / Available in 7 working days



PEZZI DA 1 MT - 1 MT PIECES



IMPIEGO

Tubo in gomma cord idoneo per passaggio di acqua calda mista a liquidi antigelo.

- Temperatura: -40°C +120°C

STRUTTURA

- Sottostrato: liscio in gomma nera EPDM resistente al calore.
- Rinforzi: tessuti sintetici ad alta resistenza.
- Copertura: in gomma nera EPDM resistente all'abrasione ad calore e all'invecchiamento.
- Superficie: liscia ad impressione tela.
- Normativa: DIN 73411-79.

APPLICATION

Softwall rubber hose suitable for conveying hot water mixed with cooling liquids.

- Temperature range: -40°C +120°C

CONSTRUCTION

- Tube: black, smooth, heat resistant EPDM rubber.
- Reinforcement: high strength synthetic textile plies.
- Cover: black, abrasion, heat and ageing resistant EPDM rubber.
- Surface: smooth fabric finished.
- According to: DIN 73411-79.



Codice Part Number	Diametro Interno Inside Diameter			Ø Esterno O.D. mm.	Pr. Esercizio Max WP bar	Pr. Scoppio Burst Pr. bar	Peso Weight Kg./mt.	Lunghezza Length mt.
	DN	Inch.	mm					
101 251 824	18	23/32"	18	24	4	12	0,28	1
101 251 925	19	3/4"	19	25	4	12	0,29	1
101 252 026	20	25/32"	20	26	4	12	0,30	1
101 252 228	22	7/8"	22	28	4	12	0,33	1
101 252 532	25	1"	25	32	4	12	0,42	1
101 252 836	28	1.3/32"	28	36	4	12	0,46	1
101 253 038	30	1.3/16"	30	38	4	12	0,58	1
101 253 240	32	1.1/4"	32	40	4	12	0,62	1
101 253 543	35	1.3/8"	35	43	4	12	0,67	1
101 253 846	38	1.1/2"	38	46	4	12	0,82	1
101 254 049	40	1.9/16"	40	49	4	12	0,86	1
101 254 251	42	1.21/32"	42	51	4	12	0,90	1
101 254 554	45	1.3/4"	45	54	4	12	1,02	1
101 255 060	50	1.31/32"	50	60	4	12	1,13	1
101 255 565	55	2.5/32"	55	65	4	12	1,32	1
101 256 070	60	2.3/8"	60	70	4	12	1,43	1
101 256 576	65	2.9/16"	65	76	4	12	1,51	1
101 257 081	70	2.3/4"	70	81	4	12	1,75	1
101 257 586	75	2.15/16"	75	86	4	12	1,80	1
101 258 092	80	3.5/32"	80	92	4	12	2,16	1
101 259 102	90	3.17/32"	90	102	4	12	2,41	1
101 251 113	100	3.15/16"	100	113	4	12	2,80	1

● Fornibile in 7 gg lavorativi / Available in 7 working days



IMPIEGO

Tubo in gomma spiralato grecato idoneo per mandata di acqua calda e liquidi antigelo nei sistemi di raffreddamento dei motori.

- Temperatura: -40° C +120°

STRUTTURA

- Sottostrato: liscio in gomma nera EPDM resistente al calore.
- Rinforzi: spirale metallica incorporata con tessuti sintetici ad alta resistenza.
- Copertura: in gomma nera EPDM resistente al calore e all'invecchiamento.
- Superficie: grecata ad impressione tela.

APPLICATION

Hardwall square corrugated cover rubber hose suitable for conveying hot water and anti-freeze liquids in engine cooling systems.

- Temperature range: -40° C +120° C

CONSTRUCTION

- Tube: black, smooth, heat resistant EPDM rubber.
- Reinforcement: steel wire helix with high strength synthetic textile plies.
- Cover: black, heat and ageing resistant EPDM rubber.
- Surface: square corrugated fabric finished.



Codice Part Number	Diametro Interno Inside Diameter			Ø Esterno O.D.	Pr. Esercizio Max WP	Pr. Scoppio Burst Pr.	Raggio Curv. Bend Radius	Peso Weight	Lunghezza Length
	DN	Inch.	mm						
100 261 625	16	5/8"	16	24	5	15	60	0,45	5 - 20
100 261 928	19	3/4"	19	27	5	15	70	0,50	5 - 20
100 262 029	20	25/32"	20	28	5	15	70	0,52	5 - 20
100 262 230	22	7/8"	22	30	5	15	75	0,54	5 - 20
100 262 533	25	1"	25	33	5	15	85	0,58	5 - 20
100 262 838	28	1.3/32"	28	36	5	15	95	0,64	5 - 20
100 263 040	30	1.3/16"	30	38	5	15	100	0,68	5 - 20
100 263 242	32	1.1/4"	32	42	5	15	105	0,76	5 - 20
100 263 545	35	1.3/8"	35	45	5	15	115	0,84	5 - 20
100 263 848	38	1.1/2"	38	48	5	15	130	0,95	5 - 20
100 264 050	40	1.9/16"	40	50	5	15	135	1,00	5 - 20
100 264 252	42	1.21/32"	42	52	5	15	140	1,18	5 - 20
100 264 555	45	1.3/4"	45	55	5	15	150	1,20	5 - 20
100 265 060	50	1.31/32"	50	61	5	15	165	1,30	5 - 20
100 265 566	55	2.5/32"	55	65	5	15	180	1,50	5 - 20
100 266 071	60	2.3/8"	60	70	5	15	200	1,70	5 - 20

● Fornibile in 7 gg lavorativi / Available in 7 working days Taglio a misura applicato sovrapprezzo di 15,00 euro / Cut To Size Applied Supplement of 15 Euro



PEZZI DA 1 A 4 MT - 1 TO 4 MT PIECES



IMPIEGO

Tubo in silicone con rinforzo in poliestere **utilizzato per sistemi di riscaldamento e refrigerazione**. Adatto per essere utilizzato in tratti dritti che non necessitano di curvatura.

- Temperatura: -60° C +180° C

STRUTTURA

- Sottostrato: silicone VMQ (Vinil methyl Quality) azzurra.
- Rinforzi: 3 rivestimenti in tessuto di poliestere.
- Copertura: liscia in silicone azzurro resistente al calore, all'ozono e agli agenti atmosferici.

APPLICATION

Silicon hose with polyester reinforcement **used for heating and refrigeration systems**.

Suitable to be used in straight sections that do not require bending.

- Temperature range: -60° C +180° C

CONSTRUCTION

- Tube: blue, silicon VMQ.
- Reinforcement: 3 finishes in polyester fabric.
- Cover: blue, smooth, ozone and weathering resistant silicon.



Codice Part Number	Diametro Interno Inside Diameter			Spessore Thickness	Pr. Esercizio Max WP	Pr. Scoppio Burst Pr.	Lunghezza Length
	Inch.	mm	mm				
100 281 626	16	5/8"	16	4,2	8,27	24,80	da 1 a 4
100 281 929	19	3/4"	19	4,2	7,27	21,80	da 1 a 4
100 282 534	25	1"	25	4,2	5,90	17,70	da 1 a 4
100 282 837	28	1.3/32"	28	4,2	5,40	16,20	da 1 a 4
100 283 040	30	1.3/16"	30	4,2	5,13	15,40	da 1 a 4
100 283 241	32	1.1/4"	32	4,2	4,90	14,70	da 1 a 4
100 283 544	35	1.3/8"	35	4,2	4,57	13,70	da 1 a 4
100 283 848	38	1.1/2"	38	4,2	4,30	12,90	da 1 a 4
100 284 050	40	1.9/16"	40	4,2	4,13	12,40	da 1 a 4
100 284 555	45	1.3/4"	45	4,2	3,77	11,3	da 1 a 4
100 284 858	48	1.7/8"	48	4,2	3,60	10,80	da 1 a 4
100 285 161	50	2"	51	4,2	3,43	10,30	da 1 a 4
100 286 070	60	2.3/8"	60	4,2	3,03	9,10	da 1 a 4
100 286 575	65	2.9/16"	65	4,2	2,83	8,50	da 1 a 4
100 287 080	70	2.3/4"	70	4,2	2,70	8,10	da 1 a 4
100 287 686	76	3"	76	4,2	2,50	7,50	da 1 a 4
100 288 090	80	3.5/32"	80	4,2	2,30	6,90	da 1 a 4
100 289 100	90	3.17/32"	90	4,2	1,90	3,00	da 1 a 4
100 281 112	100	4"	100	4,2	1,67	5,00	da 1 a 4

● Fornibile in 7 gg lavorativi / Available in 7 working days



IMPIEGO

Tubo in gomma cord idoneo per mandata di acqua calda frammista a vapore e di fluidi non corrosivi caldi.

- Temperatura: -40°C +120°C

STRUTTURA

- Sottostrato: liscio in gomma nera EPDM resistente al calore.
- Rinforzi: tessuti sintetici ad alta resistenza.
- Copertura: in gomma nera EPDM resistente all'abrasione, al calore agli agenti atmosferici e all'ozono.
- Superficie: liscia ad impressione tela.

APPLICATION

Softwall rubber hose suitable for hot water and non corrosive hot fluids and steam mix.

- Temperature range: -40°C +120°C

CONSTRUCTION

- Tube: black, smooth, heat resistant EPDM rubber.
- Reinforcement: high strength syntetic textile plies.
- Cover: black, abrasion, heat, weathering and ozone resistant EPDM rubber.
- Surface: smooth fabric finished.



Codice Part Number	Diametro Interno Inside Diameter			Ø Esterno O.D.	Pr. Esercizio Max WP	Pr. Scoppio Burst Pr.	Raggio Curv. Bend Radius	Peso Weight	Lunghezza Lenght
	DN	Inch.	mm						
• 100 271 222	11	15/12"	12	22	10	30	450	0,36	60
• 100 271 323	12	1/2"	13	23	10	30	450	0,38	60
• 100 271 525	15	19/32"	15	25	10	30	450	0,42	60
• 100 271 626	16	5/8"	16	26	10	30	450	0,44	60
• 100 271 828	18	23/32"	18	28	10	30	450	0,48	60
• 100 271 929	19	3/4"	19	29	10	30	450	0,50	60
• 100 272 030	20	25/32"	20	30	10	30	450	0,52	60
• 100 272 232	22	7/8"	22	32	10	30	450	0,56	60
• 100 272 535	25	1"	25	35	10	30	450	0,62	60
• 100 272 839	28	1.3/32"	28	39	10	30	450	0,70	60
• 100 273 042	30	1.3/16"	30	42	10	30	450	0,80	60
• 100 273 244	32	1.1/4"	32	44	10	30	450	0,89	60
• 100 273 546	35	1.3/8"	35	48	10	30	450	1,10	60
• 100 273 852	38	1.1/2"	38	52	10	30	450	1,24	60
• 100 274 054	40	1.9/16"	40	54	10	30	450	1,33	60
• 100 274 561	45	1.3/4"	45	61	10	30	450	1,63	60
• 100 275 166	51	2"	51	66	10	30	450	1,80	40

• Fornibile in 7 gg lavorativi / Available in 7 working days



IMPIEGO

Tubo in gomma cord idoneo per mandata di vapore saturo fino ad una pressione massima di 6 bar (90 PSI / +165°C).

- Temperatura: -40°C +165°C

STRUTTURA

- Sottostrato: liscio in gomma nera EPDM resistente al vapore saturo.
- Rinforzi: tessuti sintetici ad alta resistenza.
- Copertura: in gomma nera EPDM resistente all'abrasione, al calore, agli agenti atmosferici e all'ozono.
- Superficie: liscia ad impressione tela.

APPLICATION

Softwall rubber hose suitable for saturated steam up to maximum working pressure of 6 bar (90 PSI / +165°C).

- Temperature range: -40°C +165°C

CONSTRUCTION

- Tube: blue, smooth, silicon rubber.
- Reinforcement: high strength nylon textile plies.
- Cover: blue, heat, ozone and weathering resistant silicon rubber.
- Surface: smooth fabric finished.



Codice Part Number	Diametro Interno Inside Diameter			Ø Esterno O.D.	Pr. Esercizio Max WP	Pr. Scoppio Burst Pr.	Peso Weight	Lunghezza Lenght
	DN	Inch.	mm					
• 100 291 224	12	1/2"	12/13	24	6	60	0,42	61
• 100 291 627	16	5/8"	15/16	27	6	60	0,49	61
• 100 291 931	19	3/4"	19	31	6	60	0,61	61
• 100 292 538	25	1"	25	38	6	60	0,83	61
• 100 293 045	30	1.3/16"	30	45	6	60	1,10	61
• 100 293 247	32	1.1/4"	32	47	6	60	1,18	61
• 100 293 550	35	1.3/8"	35	50	6	60	1,30	61
• 100 293 854	38	1.1/2"	38	54	6	60	1,45	61
• 100 294 056	40	1.9/16"	40	56	6	60	1,50	61
• 100 295 168	50	2"	51	68	6	60	1,98	61



• Fornibile in 7 gg lavorativi / Available in 7 working days



IMPIEGO

Tubo in gomma cord metallico idoneo per mandata di vapore saturo, per servizi gravosi fino ad una **pressione massima di 17 bar (255 PSI / +206°C)**.

- Temperatura: -40°C +206°C con punte fino a 232°C (18 BAR / 270 PSI)

STRUTTURA

- Sottostrato: liscio in gomma nera speciale EPDM resistente al vapore saturo.
- Rinforzi: **filì di acciaio ad alta resistenza**.
- Copertura: in gomma rossa EPDM resistente all'abrasione, al calore, agli agenti atmosferici e all'ozono.
- Superficie: liscia ad impressione tela microforata.

APPLICATION

Steel cord rubber hose suitable for heavy duty saturated steam up to **maximum working pressure of 17 bar (255 PSI / +206°C)**.

- Temperature range: -40°C +206°C peak value up to 232°C (18 BAR / 270 PSI)

CONSTRUCTION

- Tube: black, smooth, saturated steam resistant special EPDM rubber compound.
- Reinforcement: **high strength steel wire yarn**.
- Cover: red, abrasion, heat, weathering and ozone resistant EPDM rubber.
- Surface: smooth fabric finished pin-pricked.



Codice Part Number	Diametro Interno Inside Diameter			Ø Esterno O.D.	Pr. Esercizio Max WP	Pr. Scoppio Burst Pr.	Peso Weight	Lunghezza Length
	DN	Inch.	mm					
• 100 301 021	10	3/8"	10	21	17	170	0,40	61
• 100 301 325	12	1/2"	13	25	17	170	0,53	61
• 100 301 628	16	5/8"	16	28	17	170	0,60	61
• 100 301 932	19	3/4"	19	32	17	170	0,75	61
• 100 302 538	25	1"	25	38	17	170	0,98	61
• 100 303 246	32	1.1/4"	32	46	17	170	1,29	30,5 / 61
• 100 303 854	38	1.1/2"	38	54	17	170	1,76	30,5 / 61
• 100 305 167	50	2"	51	67	17	170	2,18	30,5 / 61



• Fornibile in 7 gg lavorativi / Available in 7 working days



IMPIEGO

Tubo in gomma cord idoneo per mandata di acqua calda frammista a vapore in impieghi dove sia richiesta atossicità per i prodotti convogliati. Idoneo a sterilizzazione a vapore con punte fino a + 164 °C.

- Temperatura: -40°C +120°C

STRUTTURA

- Sottostrato: liscio in **gomma EPDM bianca alimentare resistente al calore**.
- Rinforzi: inserzioni di fibre sintetiche ad alta resistenza.
- Copertura: in gomma blu resistente all'abrasione, al calore, agli olii, ai grassi, e agli agenti atmosferici. Stabilità del colore.
- Superficie: liscia ad impressione tela.
- **Normativa: DM 21/3/73 e 18/6/79 + FDA.**

APPLICATION

Softwall rubber hose suitable for hot water and steam mix used where an atoxic hose is required. Suitable to scald with steam up to +164°C.

- Temperature range: -40°C +120°C

CONSTRUCTION

- Tube: **white**, smooth, **heat resistant food quality EPDM rubber**.
- Reinforcement: high strength syntetic textile plies.
- Cover: blue abrasion, heat, oil, fats and weathering resistant EPDM rubber. Non staining.
- Surface: smooth fabric finished.
- **According to: DM 21/3/73 e 18/6/79 + FDA.**



Codice Part Number	Diametro Interno Inside Diameter			Ø Esterno O.D.	Pr. Esercizio Max WP	Pr. Scoppio Burst Pr.	Raggio Curv. Bend Radius	Peso Weight	Lunghezza Length
	DN	Inch.	mm						
• 100 311 323	12	1/2"	13	23	10	30	130	0,37	40
• 100 311 626	16	5/8"	16	26	10	30	160	0,43	40
• 100 311 930	19	3/4"	19	30	10	30	190	0,55	40
• 100 312 537	25	1"	25	37	10	30	250	0,75	40



• Fornibile in 7 gg lavorativi / Available in 7 working days



TUBI SETTORE INDUSTRIALE
INDUSTRIAL SECTION HOSES

TUBI ATOSSICI ALIMENTARI
NON TOXIC ALIMENTARY HOSES



IMPIEGO

Tubo in **PVC retinato atossico**.
• Temperatura: -10°C +60°C

STRUTTURA

- Sottostrato: liscio in PVC trasparente atossico.
- Rinforzi: **inserzioni di filati sintetici ad alta resistenza**.
- Copertura: in PVC trasparente resistente agli agenti atmosferici e a gran parte dei prodotti chimici.
- Superficie: liscia estrusa.

APPLICATION

Netted **PVC hose non toxic**.
• Temperature range: -10° C +60° C

CONSTRUCTION

- Tube: smooth transparent PVC non toxic.
- Reinforcement: **high strength syntetic textile yarn**.
- Cover: weathering and most chemicals resistant transparent PVC.
- Surface: smooth extruded.



Codice Part Number	Diametro Interno Inside Diameter			Ø Esterno O.D. mm.	Pr. Esercizio Max WP bar	Pr. Scoppio Burst Pr. bar	Peso Weight Kg./mt.	Lunghezza Lenght mt.
	DN	Inch.	mm					
• 100 440 511	5	3/16"	5	11	20	40	0,09	100
• 100 440 612	6	1/4"	6	12	20	50	0,10	100
• 100 440 813	8	5/16"	8	13	15	65	0,11	100
• 100 441 015	10	3/8"	10	15	15	80	0,13	50 - 100
• 100 441 217	11	15/32"	12	17	12	95	0,14	50 - 100
• 100 441 318	12	1/2"	13	18	12	105	0,16	50 - 100
• 100 441 521	15	19/32"	15	21	10	120	0,21	50 - 100
• 100 441 622	16	5/8"	16	22	10	130	0,23	50 - 100
• 100 441 926	19	3/4"	19	26	8	155	0,32	50
• 100 442 229	22	7/8"	22	29	8	175	0,36	50
• 100 442 533	25	1"	25	33	8	200	0,46	50
• 100 443 038	30	1.3/16"	30	38	5	240	0,54	50
• 100 443 242	32	1.1/4"	32	42	5	255	0,73	25
• 100 443 545	35	1.3/8"	35	45	5	280	0,80	25
• 100 443 848	38	1.1/2"	38	48	5	305	0,86	25
• 100 444 050	40	1.9/16"	40	50	5	320	0,90	25
• 100 445 063	50	2"	50/51	63	4	400	1,50	25

• Fornibile in 7 gg lavorativi / Available in 7 working days



IMPIEGO

Tubo in **PVC trafilato atossico**.
• Temperatura: -10° C +60° C

STRUTTURA

- Trafilato: tubo monostrato in PVC trasparente atossico resistente all'abrasione, agli agenti atmosferici e a gran parte dei prodotti chimici.
- Durezza Shore A: 75 ± 5.
- Superficie: liscia estrusa.

APPLICATION

One-layer PVC hose non toxic.
• Temperature range: -10°C +60°C

CONSTRUCTION

- Tube: smooth transparent PVC non toxic.
- Hose: One-layer, abrasion, weathering and most chemicals resistant non toxic transparent PVC.
- Hardness Shore A: 75 ± 5.
- Surface: smooth extruded.



Codice Part Number	Diametro Interno Inside Diameter			Ø Esterno O.D. mm.	Peso Weight Kg./mt.	Lunghezza Lenght mt.
	DN	Inch.	mm			
• 100 450 306	3	1/8"	3	6	0,028	200
• 100 450 406	4	1/6"	4	6	0,021	200
• 100 450 407	4	1/6"	4	7	0,034	200
• 100 450 507	5	3/16"	5	7	0,024	200
• 100 450 508	5	3/16"	5	8	0,040	200
• 100 450 609	6	1/4"	6	9	0,046	200
• 100 450 710	7	5/18"	7	10	0,050	100
• 100 450 812	8	5/16"	8	12	0,080	100
• 100 451 014	10	3/8"	10	14	0,100	100
• 100 451 217	11	15/32"	12	17	0,150	100
• 100 451 419	14	9/16"	14	19	0,170	100
• 100 451 622	16	5/8"	16	22	0,260	100
• 100 451 825	18	23/32"	18	25	0,310	100
• 100 452 027	20	25/32"	20	27	0,340	50
• 100 452 534	25	1"	25	34	0,540	50

• Fornibile in 7 gg lavorativi / Available in 7 working days



IMPIEGO

Tubo in **PVC** con spirale acciaio **ALIMENTARE**.
• Temperatura: -10°C +60°C

STRUTTURA

- Sottostrato: liscio in PVC trasparente **ALIMENTARE**.
- Rinforzi: **spirale in acciaio**.
- Copertura: in PVC trasparente resistente agli agenti atmosferici e a gran parte dei prodotti chimici.
- Superficie: liscia estrusa.
- **Normativa: 2007 / 19 / EC.**

APPLICATION

Steel wire **PVC** hose **FOOD QUALITY**.
• Temperature range: -10° C +60° C

CONSTRUCTION

- Tube: smooth transparent **FOOD QUALITY PVC**.
- Reinforcement: **steel wire helix**.
- Cover: weathering and most chemicals resistant transparent PVC.
- Surface: smooth extruded.
- **According to: 2007 / 19 / EC.**



Codice Part Number	Diametro Interno Inside Diameter		Spessore Thickness mm.	Pr. Esercizio Max WP bar	Raggio Curv. Bend Radius mm.	Aspirazione Vacuum bar	Peso Weight Kg./mt.	Lunghezza Length mt.
	Inch.	mm						
• 100 821 016	3/8"	10	3	7	20	0,8	0,16	60
100 821 218	1/2"	12	3	7	25	0,8	0,18	60
• 100 821 420	9/16"	14	3,2	6	30	0,8	0,23	60
100 821 622	5/8"	16	3,2	6	35	0,8	0,27	60
• 100 821 824	11/16"	18	3,2	6	40	0,8	0,30	60
100 822 027	25/32"	20	3,5	5	50	0,8	0,32	60
100 822 229	7/8"	22	3,5	5	55	0,8	0,38	30
100 822 533	1"	25	4	5	75	0,8	0,49	60
100 823 038	1.3/16"	30	4,2	4,5	90	0,8	0,60	60
100 823 240	1.1/4"	32	4,2	4,5	95	0,8	0,65	60
• 100 823 544	1.3/8"	35	4,5	4	105	0,8	0,73	60
• 100 823 847	1.1/2"	38	4,5	4	115	0,8	0,80	30
100 824 049	1.9/16"	40	4,5	3	120	0,8	0,87	30
• 100 824 555	1.3/4"	45	5	3	135	0,8	1,15	30
100 825 060	2"	50/51	5	3	150	0,8	1,25	30
100 826 072	2.3/8"	60	6	2,5	180	0,7	1,80	30
100 826 375	2.1/2"	63	6	2,5	190	0,7	1,95	30
• 100 827 083	2.3/4"	70	6,5	2	210	0,7	2,20	30
100 827 089	3"	75/76	7	2	225	0,7	2,50	30
• 100 828 094	3.5/32"	80	7	2	240	0,7	2,70	30
• 100 829 104	3.17/32"	90	7	2	280	0,7	2,90	30
• 100 821 114	4"	100/102	7	2	300	0,6	3,40	30

• Fornibile in 7 gg lavorativi / Available in 7 working days



IMPIEGO

Tubo in **poliuretano con spirale acciaio alimentare**, idoneo per mandata e aspirazione di alimenti grassi e olii sia ad uso industriale che alimentare
• Temperatura: -10°C +90°C

STRUTTURA

- Sottostrato: liscio in **PU** trasparente **ALIMENTARE esente da ftalati**.
- Rinforzi: **spirale in acciaio**.
- Copertura: in PVC trasparente resistente agli agenti atmosferici e a gran parte dei prodotti chimici.
- Superficie: liscia estrusa.
- **Normativa: REG (EU)10/2011 CL. A-B-C-D2-E**

APPLICATION

Food quality steel wire polyurethane hose suitable for suction and delivery of fat food and oils for industrial and alimentary use.
• Temperature range: -10°C +90°C

CONSTRUCTION

- Tube: smooth transparent **FOOD QUALITY PU, free phthalates**.
- Reinforcement: **steel wire helix**.
- Cover: weathering and most chemicals resistant transparent PVC.
- Surface: smooth extruded.
- **According to: REG (EU)10/2011 CL. A-B-C-D2-E.**
- Surface: smooth extruded.



Codice Part Number	Diametro Interno Inside Diameter		Spessore Thickness mm.	Pr. Esercizio Max WP bar	Raggio Curv. Bend Radius mm.	Aspirazione Vacuum bar	Peso Weight Kg./mt.	Lunghezza Length mt.
	Inch.	mm						
• 100 892 028	25/32"	20	4	5	80	0,8	0,40	30
• 100 892 533	1"	25	4,2	5	100	0,8	0,52	30
• 100 893 039	1.3/16"	30	4,5	4	120	0,8	0,60	30
• 100 894 050	1.9/16"	40	4,8	4	160	0,8	0,95	30
• 100 895 060	2"	50	5,1	4	200	0,8	1,30	30
• 100 896 071	2.3/8"	60	5,5	3	240	0,8	1,75	30
• 100 898 092	3.5/32"	80	6,7	3	320	0,7	2,40	30

• Fornibile in 7 gg lavorativi / Available in 7 working days



COLORE AVORIO - IVORY COLOR



ALIMENTI SP PVC

IMPIEGO

Tubo in **PVC** con spirale in PVC alimentare.
• Temperatura: -10°C +60°C

STRUTTURA

- Sottostrato: liscio in PVC trasparente atossico.
- Rinforzi: **spirale in PVC rigido antiurto color avorio**.
- Copertura: in PVC trasparente resistente agli agenti atmosferici e a gran parte dei prodotti chimici.
- Superficie: semi ondulata **colore AVORIO**.
- **Normativa: 2007 / 19 / EC.**

APPLICATION

PVC wire **PVC** hose Food quality.
• Temperature range: -10°C +60°C

CONSTRUCTION

- Tube: smooth transparent PVC non toxic.
- Reinforcement: **impact and crush resistant ivory PVC wire helix**.
- Cover: weathering and most chemicals resistant transparent PVC.
- Surface: lightly corrugated **IVORY color**.
- **According to: 2007 / 19 / EC.**



Codice Part Number	Diametro Interno Inside Diameter		Spessore Thickness	Pr. Esercizio Max WP	Raggio Curv. Bend Radius	Aspirazione Vacuum	Peso Weight	Lunghezza Lenght
	Inch.	mm						
100 471 621	5/8"	16	2,5	6	80	0,6	0,16	50
100 472 025	25/32"	20	2,5	6	100	0,6	0,21	50
100 472 530	1"	25	2,5	6	125	0,6	0,25	50
100 473 035	1.3/16"	30	2,5	6	150	0,6	0,33	50
100 473 237	1.1/4"	32	2,5	6	160	0,6	0,35	50
100 473 540	1.3/8"	35	2,5	6	175	0,6	0,40	50
100 473 844	1.1/2"	38	3	6	190	0,6	0,43	50
100 474 046	1.9/16"	40	3	5	200	0,6	0,48	50
100 474 552	1.3/4"	45	3,5	5	225	0,6	0,64	50
100 475 058	2"	50/51	4	5	250	0,6	0,76	50
100 476 069	2.3/8"	60	4,5	4	330	0,6	0,90	50
100 477 079	2.3/4"	70	4,5	4	390	0,6	1,13	50
100 477 584	3"	75	4,5	4	415	0,6	1,26	50
100 478 089	3.5/32"	80	4,5	3,5	480	0,6	1,45	30
100 479 102	3.17/32"	90	6	3,5	540	0,6	1,79	30
100 471 112	4"	100	6	3,5	600	0,6	2,10	30
100 471 132	4.3/4"	120	6	3	720	0,6	2,85	30
100 471 164	6"	150	7	3	900	0,6	4,25	20

• Fornibile in 7 gg lavorativi / Available in 7 working days



COLORE GIALLO - YELLOW COLOR



ALIMENTI FLEX

IMPIEGO

Tubo in **PVC superelastico con spirale PVC alimentare gialla**.
• Temperatura: -10°C +60°C

STRUTTURA

- Sottostrato: liscio in PVC superelastico trasparente **ALIMENTARE**, senza presenza di ftalati.
- Rinforzi: **spirale in PVC rigido antiurto color giallo**.
- Copertura: in PVC trasparente resistente agli agenti atmosferici e a gran parte dei prodotti chimici.
- Superficie: semi ondulata **colore GIALLO**.
- **Normativa: EU 10/2011 Class A, B, C.**

APPLICATION

FOOD QUALITY yellow PVC wire PVC hose.
• Temperature range: -10°C +60°C

CONSTRUCTION

- Tube: smooth transparent superelastic **FOOD QUALITY** PVC, phthalate free.
- Reinforcement: **impact and crush resistant yellow PVC wire helix**.
- Cover: weathering and most chemicals resistant transparent PVC.
- Surface: lightly corrugated **YELLOW color**.
- **According to: EU 10/2011 Class A, B, C.**



Codice Part Number	Diametro Interno Inside Diameter		Spessore Thickness	Pr. Esercizio Max WP	Raggio Curv. Bend Radius	Aspirazione Vacuum	Peso Weight	Lunghezza Lenght
	Inch.	mm						
100 892 025	25/32"	20	2,5	6	70	0,6	0,21	50
100 892 530	1"	25	2,5	6	100	0,6	0,25	50
100 893 035	1.3/16"	30	2,5	6	120	0,6	0,33	50
100 893 237	1.1/4"	32	2,5	6	130	0,6	0,35	50
100 893 844	1.1/2"	38	3	6	155	0,6	0,43	50
100 894 046	1.9/16"	40	3	5	160	0,6	0,48	50
100 894 552	1.3/4"	45	3,5	5	190	0,6	0,64	50
100 895 058	2"	50/51	4	5	205	0,6	0,76	50
100 896 069	2.3/8"	60	4,5	4	240	0,6	0,90	50
100 897 079	2.3/4"	70	4,5	4	280	0,6	1,13	50
100 897 584	3"	75	4,5	4	325	0,6	1,26	50
100 898 089	3.5/32"	80	4,5	3,5	330	0,6	1,45	50
100 899 102	3.17/32"	90	6	3,5	360	0,6	1,79	50
100 891 112	4"	100	6	3,5	420	0,6	2,10	50

• Fornibile in 7 gg lavorativi / Available in 7 working days



IMPIEGO

Tubo in **PVC** con spirale PVC alimentare per travaso divino ed alcolici fino al 28° grado nell'industria enologica. Struttura pesante.

- Temperatura: -10°C +60°C

STRUTTURA

- Sottostrato: liscio in PVC trasparente alimentare.
- Rinforzi: **spirale in PVC rigido antiurto color rosso.**
- Copertura: in PVC trasparente resistente agli agenti atmosferici e a gran parte dei prodotti chimici.
- Superficie: liscia.
- **Normativa: 2007/19/EC.**

APPLICATION

PVC wire PVC hose alimentary for suction and discharge of food stuffs, wine, beer. Heavy duty.

- Temperature range: -10°C +60°C

CONSTRUCTION

- Tube: smooth transparent PVC alimentary.
- Reinforcement: **impact and crush resistant red PVC wire helix.**
- Cover: weathering and most chemicals resistant transparent PVC.
- Surface: smooth.
- **According to: 2007/19/EC.**



Codice Part Number	Diametro Interno Inside Diameter		Spessore Thickness	Pr. Esercizio Max WP	Pr. Scoppio Burst Pr.	Raggio Curv. Bend Radius	Aspirazione Vacuum	Peso Weight	Lunghezza Length
	Inch.	mm	mm.	bar	bar	mm.	bar	Kg./mt.	mt.
• 100 532 028	3/4"	20	4	8	24	140	0,9	0,35	50
• 100 532 533	1"	25	4	8	24	175	0,9	0,40	50
• 100 533 038	1.3/16"	30	4	8	24	210	0,9	0,50	50
• 100 534 049	1.9/16"	40	4,5	8	24	260	0,9	0,75	50
• 100 535 059	2"	50	4,5	8	24	325	0,9	1,00	50
• 100 536 071	2.3/8"	60	5,5	7	21	380	0,9	1,45	50
• 100 538 093	3.5/32"	80	6,5	5	15	530	0,9	2,20	50
• 100 531 116	4"	100	8	4	12	700	0,9	3,30	30
• 100 531 136	4.3/4"	120	8	4	12	900	0,9	3,60	30

• Fornibile in 7 gg lavorativi / Available in 7 working days



IMPIEGO

Tubo in **gomma** per mandata di latte e prodotti alimentari grassi.

- Temperatura: -40°C +80°C - sterilizzazione a +110°C per un massimo di 30'

STRUTTURA

- Sottostrato: bianco, liscio in gomma NBR, di qualità alimentare, inodore ed insapore.
- Rinforzi: tessuti sintetici ad alta resistenza.
- Copertura: blu in gomma NBR, resistente all'abrasione, all'ozono ed agli agenti atmosferici.
- Superficie: liscia ad impressione tela.
- **Normativa: FDA titolo 21 art. 177.2600 (f) per alimenti grassi, BfR, AD free, D.M. 21/03/73, CE 1935/2004.**

APPLICATION

Rubber hose suitable for delivery milk and fatty foods products.

- Temperature range: -40°C +80°C - sterilization at 110°C for 30 minutes max.

CONSTRUCTION

- Tube: white, smooth NBR rubber compound, food quality odourless and taste free.
- Reinforcement: high strength synthetic textile piles.
- Cover: blue NBR rubber, resistant to abrasion, ozone and weathering.
- Surface: smooth fabric finished.
- **According to: FDA title 21 art. 177.2600 (f) for fatty foods, BfR, AD free, D.M. 21/03/73, CE 1935/2004.**



Codice Part Number	Diametro Interno Inside Diameter			Ø Esterno O.D.	Pr. Esercizio Max WP	Pr. Scoppio Burst Pr.	Peso Weight	Lunghezza Length
	DN	Inch.	mm	mm.	bar	bar	Kg./mt.	mt.
• 100 481 931	19	3/4"	19	29	10	30	0,67	40
• 100 482 537	25	1"	25	35	10	30	0,80	40
• 100 483 042	30	1.3/16"	30	42	10	30	1,11	40
• 100 483 244	32	1.1/4"	32	44	10	30	1,23	40
• 100 483 547	35	1.3/8"	35	47	10	30	1,30	40
• 100 483 852	38	1.1/2"	38	50	10	30	1,38	40
• 100 484 054	40	1.9/16"	40	52	10	30	1,41	40
• 100 484 557	45	1.3/4"	45	57	10	30	1,55	40
• 100 485 067	50	2"	51	64	10	30	1,88	40
• 100 486 080	60	2.3/8"	60	73	10	30	2,24	40

• Fornibile in 7 gg lavorativi / Available in 7 working days



IMPIEGO

Tubo in **gomma spiralato** liscio ad alta flessibilità per aspirazione e mandata di acqua potabile, sostanze commestibili vegetali ed animali e liquidi alimentari anche contenenti grassi.

- Temperatura: -20°C +80°C - sterilizzazione +120°C max. 30 minuti con punte a + 150°C

STRUTTURA

- Sottostrato: **liscio in gomma butile BIANCO** alimentare studiata per garantire assoluta atossicità ed inalterabilità del sapore e profumo del prodotto convogliato (Registrato RAL - F12).
- Rinforzi: spirale metallica incorporata con tessuti sintetici ad alta resistenza.
- Copertura: in gomma blu resistente all'abrasione, ai grassi, all'ozono, agli agenti atmosferici e marini.
- Superficie: liscia ad impressione tela.
- **Normativa: conforme alle norme EUROPEE ed agli standard F.D.A.**

APPLICATION

Hardwall smooth cover **rubber hose** suitable for suction and delivery of drinking water and alimentary liquids with greases too. The structure ensures an exceptional flexibility.

- Temperature range: -20°C +80°C - sterilization +120°C max. 30 minutes up to +150°C

CONSTRUCTION

- Tube: **smooth, WHITE alimentary butyl** to assure a total no-toxic quality and immutability of tasting and smelling of the conveyed products. (RAL - F12 registered).
- Reinforcement: steel wire helix with high strength synthetic textile plies.
- Cover: blue, abrasion, greases, ozone, weathering and marine agents resistant rubber.
- Surface: smooth fabric finished
- **According to: EUROPEAN and F.D.A. standard.**



Codice Part Number	Diametro Interno Inside Diameter		Spessore Thickness	Pr. Esercizio Max WP	Pr. Scoppio Burst Pr.	Raggio Curv. Bend Radius	Aspirazione Vacuum	Peso Weight	Lunghezza Length
	Inch.	mm							
• 100 491 931	3/4"	19	31	10	30	40	0,9	0,65	20 - 40
• 100 492 537	1"	25	37	10	30	55	0,9	0,75	20 - 40
• 100 493 042	1.3/16"	30	42	10	30	65	0,9	0,87	20 - 40
• 100 493 244	1.1/4"	32	44	10	30	70	0,9	0,90	20 - 40
• 100 493 852	1.1/2"	38	52	10	30	80	0,9	1,25	20 - 40
• 100 494 054	1.9/16"	40	54	10	30	85	0,9	1,31	20 - 40
• 100 494 559	1.3/4"	45	59	10	30	100	0,9	1,45	20 - 40
• 100 495 065	2"	51	65	10	30	110	0,9	1,61	20 - 40
• 100 496 076	2.3/8"	60	76	10	30	130	0,9	2,07	20 - 40

• Fornibile in 7 gg lavorativi / Available in 7 working days



IMPIEGO

Tubo in **gomma** long length idoneo per mandata di acqua calda in impieghi dove sia richiesta atossicità per i prodotti convogliati.

- Temperatura: -35°C +110°C

STRUTTURA

- Sottostrato: liscio in **gomma nera EPDM** alimentare resistente al calore.
- Rinforzi: **inserzioni di filati sintetici ad alta resistenza.**
- Copertura: in gomma **nera EPDM** resistente all'abrasione, al calore e all'invecchiamento.
- Superficie: liscia estrusa.
- Normativa: DM 21/3/73 e 18/6/79 + FDA.

APPLICATION

Long length **rubber** hose suitable for delivery of hot water in uses where an atoxic hose is required.

- Temperature range: -35°C +110°C

CONSTRUCTION

- Tube: **black, smooth, heat resistant food-quality EPDM rubber.**
- Reinforcement: **high strength synthetic textile yarn.**
- Cover: **black, abrasion, heat and ageing resistant EPDM rubber.**
- Surface: smooth extruded.
- According to: SDM 21/3/73 and 18/6/79 + FDA.



Codice Part Number	Diametro Interno Inside Diameter		Ø Esterno O.D.	Pr. Esercizio Max WP	Pr. Scoppio Burst Pr.	Raggio Curv. Bend Radius	Peso Weight	Lunghezza Length
	DN	Inch. mm						
• 100 500 815	8	5/16"	8	15	15	45	0,16	100
• 100 501 017	10	3/8"	10	17	15	45	0,19	100
• 100 501 219	11	15/12"	12	19,5	15	45	0,27	100

• Fornibile in 7 gg lavorativi / Available in 7 working days



IMPIEGO

Tubo in **gomma** long length idoneo per mandata di acqua calda in impieghi dove sia richiesta atossicità per i prodotti convogliati.

- Temperatura: -35°C +110°C

STRUTTURA

- Sottostrato: liscio in **gomma nera EPDM** alimentare resistente al calore.
- Rinforzi: **inserzioni di filati sintetici ad alta resistenza**.
- Copertura: in gomma **azzurra o rossa EPDM** resistente all'abrasione, al calore e all'invecchiamento.
- Superficie: liscia estrusa.
- Normativa: DM 21/3/73 e 18/6/79 + FDA.

APPLICATION

Long length **rubber** hose suitable for delivery of hot water in uses where an atoxic hose is required.

- Temperature range: -35°C +110°C

CONSTRUCTION

- Tube: **black**, smooth, heat resistant food-quality **EPDM rubber**.
- Reinforcement: **high strength sythetic textile yarn**.
- Cover: **blue or red**, abrasion, heat and ageing resistant **EPDM rubber**.
- Surface: smooth extruded.
- According to: SDM 21/3/73 and 18/6/79 + FDA.

BLU



Codice Part Number	Diametro Interno Inside Diameter			Ø Esterno O.D.	Pr. Esercizio Max WP	Pr. Scoppio Burst Pr.	Raggio Curv. Bend Radius	Peso Weight	Lunghezza Length
	DN	Inch.	mm						
100 511 119	11	7/16"	11	19	15	45	55	0,26	100
100 511 320	12	1/2"	13	20	15	45	80	0,27	100



ROSSO



Codice Part Number	Diametro Interno Inside Diameter			Ø Esterno O.D.	Pr. Esercizio Max WP	Pr. Scoppio Burst Pr.	Raggio Curv. Bend Radius	Peso Weight	Lunghezza Length
	DN	Inch.	mm						
100 512 320	12	1/2"	13	20	15	45	80	0,27	100

• Fornibile in 7 gg lavorativi / Available in 7 working days



IMPIEGO

Tubo in **gomma cord** per mandata di prodotti alimentari-liquidi e solidi ad alto potere abrasivo quali zuccheri, grano, cereali e sfarinati per alimentazione. Particolarmente idoneo per passaggio granuli in PVC.

- Temperatura: -30°C +80°C

STRUTTURA

- Sottostrato: liscio in gomma bianca antistatica resistente all'abrasione.
- Rinforzi: **tessuti sintetici ad alta resistenza e cordicella in rame ANTISTATICA**.
- Copertura: in gomma blu antistatica resistente all'abrasione e agli agenti atmosferici e ozono.
- Superficie: liscia ad impressione tela.
- Normativa: standard **FDA**.

APPLICATION

Softwall bulk materials handling **rubber** hose suitable for delivery of solids and bulk liquids food products as sugar, corn, flavour and PVC granules.

- Temperature range: -30°C +80°C

CONSTRUCTION

Tube: white, smooth antistatic rubber abrasion resistant.

- Reinforcement: **high strength sythetic textile plies and copper ANTISTATIC wire**.
- Cover: blu, abrasion and weathering resistant antistatic rubber.
- Surface: smooth fabric finished
- According to: **FDA** standards.



Codice Part Number	Diametro Interno Inside Diameter			Ø Esterno O.D.	Pr. Esercizio Max WP	Pr. Scoppio Burst Pr.	Peso Weight	Lunghezza Length
	DN	Inch.	mm					
100 521 112	100	4"	102	112	5	15	2,00	20
100 521 118	100	4"	102	118	5	15	3,10	20



• Fornibile in 7 gg lavorativi / Available in 7 working days

SILICONE

IMPIEGO

Tubo in **SILICONE trafilato alimentare**.

- Temperatura: -40°C +200°C

STRUTTURA

- Trafilato: tubo monoestruso in **SILICONE** trasparente resistente all'abrasione, al calore, agli agenti atmosferici e a gran parte dei prodotti chimici.

Peso specifico (UNI 7092-A): **g/cm³ 1,180**; Durezza (UNI EN ISO 868): **SHORE A 60 ± 5**; Carico di rottura (UNI 6065): **MPa 8**; Allungamento a rottura (UNI 6065): **300 %**; Resistenza alla lacerazione (ASTM 0 624/B): **KN/m 15**; Compression Set Sch.25% 22h a 175°C (UNI ISO 815): **40%** I manufatti dopo vulcanizzazione e post-vulcanizzazione risultano composti da: METIL-VINIL-POLISILOSSANO rinforzato da SILICE ottenuta per virogenesi.

- Superficie: liscia estrusa.
- Normativa: la miscela siliconica risponde alle normative delle Autorità per la Salute tedesche, alla norma americana FDA 177.2600 e al D.Ministeriale n. 220 del 26/04/1993 e al D.Legge n.108 del 25/01/1992 attuazione direttiva 89/109/CEE.

Disponibile su richiesta: rivestimento in calza di acciaio zincato e in calza tessile.

APPLICATION

Food one-layer SILICON hose.

- Temperature range: -40°C +200°C

CONSTRUCTION

- One-layer, abrasion, heat, weathering and most chemicals resistant non toxic transparent **silicon**.

Specific weight (UNI 7092-A): **g/cm³ 1,180**; Hardness (UNI EN ISO 868): **SHORE A 60 ± 5**; Breaking load (UNI 6065): **MPa 8**; Stretching (UNI 6065): **300%**; Tearing (ASTM 0 624/B): **KN/m 15**; Compression set Sch.25% 22h a 175°C (UNI ISO 815): **40%**

Products after vulcanization are compounded by: METYL-VYNYL-POLISYLOSSAN strengthened by FUMED SILICA.

- Surface: smooth extruded.
- According to: silicon raw materials are according:
 - German health regulations
 - American regulations FDA 177.2600
 - Italian regulations D.M. no. 220 dtd 26/04/1993 and L.D. no. 108 dtd 25/01/1992.

Available on request:
galvanized steel wire braid cover; textile braid cover.

TUBI SETTORE INDUSTRIALE
INDUSTRIAL SECTION HOSES

TUBI PER PRODOTTI CHIMICI
CHEMICAL PRODUCTS HOSES



Codice Part Number	Diametro Interno Inside Diameter		Ø Esterno O.D. mm.	Peso Weight Kg./mt.	Lunghezza Lenght mt.
	Inch.	mm			
• 100 540 305	1/8"	3	5	0,015	25
• 100 540 306	1/8"	3	6	0,025	25
• 100 540 406	1/6"	4	6	0,019	25
• 100 540 407	1/6"	4	7	0,031	25
• 100 540 408	1/6"	4	8	0,045	25
• 100 540 508	3/16"	5	8	0,037	25
• 100 540 609	1/4"	6	9	0,042	25
• 100 540 612	1/4"	6	13	0,101	25
• 100 540 914		9	14	0,220	25
• 100 541 015	3/8"	10	15	0,270	25
• 100 541 216	15/12"	12	16	0,320	25

• Fornibile in 7 gg lavorativi / Available in 7 working days



IMPIEGO

Tubo in **gomma cord** idoneo per mandata di prodotti chimici, acidi organici e inorganici anche ad alta concentrazione.

- Temperatura: -35°C +100°C

STRUTTURA

- Sottostrato: liscio in gomma nera conduttiva resistente ai prodotti chimici.
- Rinforzi: **tessuti sintetici** ad alta resistenza.
- Copertura: in gomma nera EPR resistente all'abrasione, ai prodotti chimici, agli agenti atmosferici e all'ozono.
- Superficie: liscia ad impressione tela

APPLICATION

Softwall rubber hose suitable for chemical products, organic and inorganic acids at high concentration too.

- Temperature range: -35°C +100°C

CONSTRUCTION

- Tube: black, smooth, conductive, chemical products resistant rubber.
- Reinforcement: high strength **synthetic textile plies**.
- Cover: black, abrasion, chemical products, weathering and ozone resistant EPR rubber.
- Surface: smooth fabric finished.



Codice Part Number	Diametro Interno Inside Diameter			Ø Esterno O.D.		Pr. Esercizio Max WP	Pr. Scoppio Burst Pr.	Peso Weight	Lunghezza Lenght
	DN	Inch.	mm	mm.	mm.				
• 100 652 030	20	25/32"	20	30	10	30	0,57	10 - 40	
• 100 652 535	25	1"	25	35	10	30	0,65	10 - 40	
• 100 653 042	30	1.3/16"	30	42	10	30	0,84	10 - 40	
• 100 653 244	32	1.1/4"	32	44	10	30	0,86	10 - 40	
• 100 653 852	38	1.1/2"	38	52	10	30	1,20	10 - 20	
• 100 655 166	50	2"	51	66	10	30	1,80	< 12	



IMPIEGO

Tubo in **gomma cord** idoneo per mandata di prodotti chimici, acidi organici e inorganici anche ad alta concentrazione.

- Temperatura: -35°C +100°C

STRUTTURA

- Sottostrato: liscio in gomma nera EPR.
- Rinforzi: **spirale metallica** incorporata **tessuti sintetici** ad alta resistenza.
- Copertura: in gomma nera EPR resistente all'abrasione, ai prodotti chimici, agli agenti atmosferici e all'ozono.
- Superficie: liscia ad impressione tela.

APPLICATION

Softwall rubber hose suitable for chemical products, organic and inorganic acids at high concentration too.

- Temperature range: -35°C +100°C

CONSTRUCTION

- Tube: black, smooth, EPR rubber.
- Reinforcement: **steel wire helix** with high strength **synthetic textile plies**.
- Cover: black, abrasion chemical products, weathering and ozone resistant EPR rubber.
- Surface: smooth fabric finished.



Codice Part Number	Diametro Interno Inside Diameter			Ø Esterno O.D.		Pr. Esercizio Max WP	Pr. Scoppio Burst Pr.	Raggio Curv. Bend Radius	Aspirazione Vacuum	Peso Weight	Lunghezza Lenght
	Inch.	mm	mm.	mm.	mm.						
• 100 664 053	1.9/16"	40	53	10	30	240	0,9	1,30	20 - 40		
• 100 665 165	2"	51	65	10	30	300	0,9	1,85	20 - 40		
• 100 666 074	2.3/8"	60	74	10	30	360	0,9	2,13	20 - 40		
• 100 667 692	3"	76	92	10	30	450	0,9	2,70	20 - 40		
• 100 668 096	3.5/32"	80	96	10	30	480	0,9	2,83	20 - 40		

FORNIBILE A RICHIESTA - ON REQUEST



IMPIEGO

Tubo in **gomma cord** idoneo per mandata di una vasta gamma di prodotti chimici, alimentari, petroliferi e olii.

- Temperatura: -25°C +90°C

STRUTTURA

- Sottostrato: liscio in polietilene ad altissimo peso molecolare (UHMWPE) nero antiabrasivo conduttivo e alimentare secondo **F.D.A. e normative alimentari Europee**.
- Rinforzi: **tessuti sintetici** ad alta resistenza.
- Copertura: in gomma blu conduttiva resistente all'abrasione, ai prodotti chimici, agli agenti atmosferici e all'ozono.
- Superficie: liscia ad impressione tela.

Disponibile su richiesta con coperture colorate.

APPLICATION

Softwall rubber hose suitable delivery of a wide range of chemical, alimentary, petroleum products and oils.

- Temperature range: -25°C +90°C

CONSTRUCTION

- Tube: smooth, black, conductive, food quality abrasion resistant (UHMWPE). According to **F.D.A. and European alimentary standards**.
- Reinforcement: high strength **syntetic textile plies**.
- Cover: blue, conductive, abrasion, chemical products, weathering and ozone resistant rubber.
- Surface: smooth fabric finished.

Available on request with coloured covers.



Codice Part Number	Diametro Interno Inside Diameter		Ø Esterno O.D.	Pr. Esercizio Max WP	Pr. Scoppio Burst Pr.	Aspirazione Vacuum	Peso Weight	Lunghezza Lenght
	Inch.	mm						
• 100 690 815	5/16"	8	15	16	48	0,3	0,15	40
• 100 691 018	3/8"	10	18	16	48	0,3	0,21	40
• 100 691 323	1/2"	13	23	16	48	0,3	0,34	40
• 100 691 626	5/8"	16	26	16	48	0,3	0,40	40
• 100 691 931	3/4"	19	31	16	48	0,3	0,55	40
• 100 692 537	1"	25	37	16	48	0,3	0,68	40

• Fornibile in 7 gg lavorativi / Available in 7 working days



IMPIEGO

Tubo in gomma spiralato liscio idoneo per aspirazione e mandata di una vasta gamma di prodotti chimici, alimentari, petroliferi e olii. Utilizzato anche per prodotti alimentari, vegetali, animali e alcolici.

- Temperatura: -25°C +100°C fino a +130°C max 30 min.

STRUTTURA

- Sottostrato: **BIANCO** liscio in polietilene trasparente ad altissimo peso molecolare (UHMWPE) antiabrasivo e alimentare secondo **F.D.A. e normative alimentari Europee**.
- Rinforzi: **spirale metallica** incorporata con tessuti sintetici ad alta resistenza e cordicella di rame.
- Copertura: in gomma blu speciale resistente all'abrasione, ai prodotti chimici, agli agenti atmosferici e all'ozono.
- Superficie: liscia ad impressione tela.

Disponibile la versione SUPERIOR/16HF/SDN con **sottostrato nero conduttivo**. Tubo conforme alle norme EN 12115-1999 tipo Ω e TRbf 131 Teil 2 Par. 5.5

APPLICATION

Hardwall smooth cover rubber hose suitable for suction and delivery of a wide range of chemical, alimentary, petroleum products and oils. Suitable also for animal, vegetable, foodstuffs and alcoholic drinks.

- Temperature range: -25°C +100°C up to +130°C max 30 min.

CONSTRUCTION

- Tube: **WHITE** transparent, smooth, high weight cross-linked abrasion resistant polyethylene (UHMWPE) according to **F.D.A. and European alimentary standards**.
- Reinforcement: **steel wire helix** with high strength syntetic textile plies and copper wire.
- Cover: blue, abrasion, chemical products, weathering and ozone resistant special rubber.
- Surface: smooth fabric finished.

Available on request SUPERIOR/16HF/SDN with **black conductive tube**. According to EN 12115-199 type Ω and TRbf 131 Teil 2 Par. 5.5.



Codice Part Number	Diametro Interno Inside Diameter		Ø Esterno O.D.	Pr. Esercizio Max WP	Pr. Scoppio Burst Pr.	Raggio Curv. Bend Radius	Aspirazione Vacuum	Peso Weight	Lunghezza Lenght
	Inch.	mm							
• 100 671 926	3/4"	19	31	16	48	125	0,9	0,68	20 - 40
• 100 672 537	1"	25	37	16	48	150	0,9	0,85	20 - 40
• 100 673 042	1.3/16"	30	42	16	48	160	0,9	0,97	20 - 40
• 100 673 244	1.1/4"	32	44	16	48	175	0,9	1,02	20 - 40
• 100 673 851	1.1/2"	38	51	16	48	225	0,9	1,20	20 - 40
• 100 674 053	1.9/16"	40	53	16	48	235	0,9	1,30	20 - 40
• 100 675 165	2"	51	65	16	48	275	0,9	1,78	20 - 40
• 100 676 074	2.3/8"	60	74	16	48	300	0,9	2,40	20 - 40

• Fornibile in 7 gg lavorativi / Available in 7 working days



TUBI SETTORE INDUSTRIALE
INDUSTRIAL SECTION HOSES

TUBI PER MATERIALI ABRASIVI
ABRASIVES MATERIALS HOSES



IMPIEGO

Tubo in **gomma cord** per mandata di sabbia o graniglia metallica, utilizzato negli impianti di sabbatura. Ottima resistenza all'abrasione.

- Temperatura: -40°C +70°C

STRUTTURA

- Sottostrato: liscio in gomma nera NR/SBR antistatica resistente all'abrasione.
- Rinforzi: **tessuti sintetici ad alta resistenza.**
- Copertura: in gomma nera NR/SBR antistatica resistente all'abrasione e agli agenti atmosferici.
- Superficie: liscia ad impressione tela

- Normativa: perdita di abrasione del sottostrato secondo ISO DIN 53516: max 50 mm3 ± 5.

APPLICATION

Tubo in **gomma cord** per lancio di betoncino, intonaco e gesso.

- Temperatura: -40°C +70°C

CONSTRUCTION

- Sottostrato: liscio in gomma nera NR/SBR antistatica resistente all'abrasione.
- Rinforzi: **tessuti sintetici ad alta resistenza.**
- Copertura: in gomma nera NR/SBR antistatica resistente all'abrasione e agli agenti atmosferici.
- Superficie: liscia ad impressione tela
- Normativa: perdita di abrasione del sottostrato secondo ISO DIN 53516: max 75 mm3 ± 5.



Codice Part Number	Diametro Interno Inside Diameter			Ø Esterno O.D.		Pr. Esercizio Max WP	Pr. Scoppio Burst Pr.	Peso Weight	Lunghezza Length
	DN	Inch.	mm	mm.	mm.				
• 100 691 325	12	1/2"	13	25	18	54	0,44	40	
• 100 691 630	16	5/8"	16	30	18	54	0,59	40	
• 100 691 930	19	3/4"	19	30	18	54	0,50	40	
• 100 692 540	25	1"	25	40	18	54	0,87	40	
• 100 693 045	30	1.3/16"	30	45	18	54	1,02	40	
• 100 693 248	32	1.1/4"	32	48	18	54	1,16	40	
• 100 693 554	35	1.3/8"	35	54	18	54	1,53	40	
• 100 693 854	38	1.1/2"	38	54	18	54	1,32	40	
• 100 694 060	40	1.9/16"	40	60	18	54	1,83	40	
• 100 695 170	50	2"	51	70	18	54	2,10	20 - 40	
• 100 696 080	60	2.3/8"	60	80	18	54	2,50	20 - 40	
• 100 696 584	65	2.9/16"	65	84	18	54	2,60	20 - 40	

• Fornibile in 7 gg lavorativi / Available in 7 working days



IMPIEGO

Tubo in **gomma cord** per lancio di betoncino, intonaco e gesso.

- Temperatura: -40°C +70°C

STRUTTURA

- Sottostrato: liscio in gomma nera NR/SBR antistatica resistente all'abrasione.
- Rinforzi: **tessuti sintetici ad alta resistenza.**
- Copertura: in gomma nera NR/SBR antistatica resistente all'abrasione e agli agenti atmosferici.
- Superficie: liscia ad impressione tela
- Normativa: perdita di abrasione del sottostrato secondo ISO DIN 53516: max 75 mm3 ± 5.

APPLICATION

Softwall rubber engineered for plaster and concrete spraying.

- Temperature range: -40°C +70°C

CONSTRUCTION

- Tube: black, smooth antistatic NR/SBR rubber abrasion resistant.
- Reinforcement: **high strength sythetic textile plies.**
- Cover: black, abrasion and weathering resistant antistatic NR/SBR rubber.
- Surface: smooth fabric finished.
- According to: abrasion loss of the tube rubber compound according to ISO DIN 53516: max 75 mm3 ± 5.



Codice Part Number	Diametro Interno Inside Diameter			Ø Esterno O.D.		Pr. Esercizio Max WP	Pr. Scoppio Burst Pr.	Peso Weight	Lunghezza Length
	DN	Inch.	mm	mm.	mm.				
• 100 702 538	25	1"	25	38	40	120	0,72	60	
• 100 703 246	32	1.1/4"	32	46	40	120	0,94	40	
• 100 703 549	35	1.3/8"	35	49	40	120	1,02	40	
• 100 704 054	40	1.9/16"	40	54	40	120	1,08	40	
• 100 705 167	50	2"	51	67	40	120	1,65	40	

• Fornibile in 7 gg lavorativi / Available in 7 working days



IMPIEGO

Tubo in **gomma cord** per mandata di cemento, sabbia umida e materiali abrasivi secchi.

- Temperatura: -40°C +70°C

STRUTTURA

- Sottostrato: liscio in gomma nera NR/SBR antistatica resistente all'abrasione.
- Rinforzi: tessuti sintetici ad alta resistenza.
- Copertura: in gomma nera NR/SBR antistatica resistente all'abrasione e agli agenti atmosferici.
- Superficie: liscia ad impressione tela.

Disponibile su richiesta:
CEMENTUB/PA sottostrato in gomma para beige CEMENTUB/SP10L con spirale in acciaio
CEREALI/10 sottostrato atossico bianco

APPLICATION

Softwall bulk materials handling **rubber** hose suitable for delivery of cement, wet sand and dry abrasive materials.

- Temperature range: -40°C +70°C

CONSTRUCTION

- Tube: black, smooth antistatic NR/SBR rubber abrasion resistant.
- Reinforcement: high strength syntetic textile plies.
- Cover: black, abrasion and weathering resistant antistatic NR/SBR rubber.
- Surface: smooth fabric finished.

Available on request:
CEMENTUB/PA beige natural rubber tube CEMENTUB/SP10L with steel wire
CEREALI/10 white non toxic tube



Codice Part Number	Diametro Interno Inside Diameter			Ø Esterno O.D.		Pr. Esercizio Max WP	Pr. Scoppio Burst Pr.	Peso Weight Kg./mt.	Lunghezza Lenght mt.
	DN	Inch.	mm	mm.	mm.				
100 711 110	100	4"	102	110	110	10	30	2,00	20
100 711 118	100	4"	102	118	118	10	30	3,10	20

• Fornibile in 7 gg lavorativi / Available in 7 working days



IMPIEGO

Tubo in **poliuretano con spirale pvc** utilizzato per il trasporto in continuo dell'intonaco premiscelato dal silos all'intonacatrice.

- Temperatura: -10°C +60°C

STRUTTURA

- Sottostrato: liscio in poliuretano trasparente resistente all'abrasione.
- Rinforzi: **spirale in pvc rigido antiurto** color avorio.
- Copertura: in pvc trasparente resistente agli agenti atmosferici e a gran parte dei prodotti chimici.
- Superficie: semi-ondulata.

APPLICATION

Pvc wire polyurethane hose used for continuous conveyance of pre-mixed plaster from silos to the plaster-sprayer.

- Temperature range: -10°C +60°C

CONSTRUCTION

- Tube: smooth, abrasion resistant transparent polyurethane.
- Reinforcement: impact and crush resistant ivory **pvc wire helix**.
- Cover: weathering and most chemicals resistant transparent pvc.
- Surface: lightly corrugated.



Codice Part Number	Diametro Interno Inside Diameter		Ø Esterno O.D.	Pr. Esercizio Max WP	Raggio Curv. Bend Radius	Aspirazione Vacuum	Peso Weight Kg./mt.	Lunghezza Lenght mt.
	Inch.	mm						
100 734 552	1.3/4"	45	3,5	4,5	270	0,6	0,60	25
100 735 159	2"	51	4,0	4,5	300	0,6	0,73	50
100 736 069	2.3/8"	60	4,5	4,0	360	0,6	0,87	50

• Fornibile in 7 gg lavorativi / Available in 7 working days



IMPIEGO

Tubo in **poliuretano con spirale in PVC** idoneo per aspirazione di polveri e altro materiale abrasivo.

- Temperatura: -25°C +85°C

STRUTTURA

- Sottostrato: liscio in poliuretano trasparente antiabrasivo.
- Rinforzi: **spirale in PVC** rigido antiurto.
- Copertura: in poliuretano trasparente antiabrasivo.

APPLICATION

PVC wire polyurethane hose suitable for suction of dust and other abrasive material.

- Temperature range: -25°C +85°C

CONSTRUCTION

- Tube: smooth, abrasion resistant transparent polyurethane.
- Reinforcement: **PVC wire helix**.
- Cover: abrasion resistant transparent polyurethane.



Codice Part Number	Diametro Interno Inside Diameter		Spessore Thickness	Raggio Curv. Bend Radius	Aspirazione Vacuum	Peso Weight	Lunghezza Length
	Inch.	mm					
• 100 832 024	25/32"	20	0,35	20	5	0,10	20
• 100 832 229	7/8"	22	0,35	22	5	0,13	20
• 100 832 529	1"	25	0,35	25	5	0,15	20
• 100 833 034	1.3/16"	30	0,35	30	5	0,19	20
• 100 833 539	1.3/8"	35	0,35	35	4	0,22	20
• 100 834 046	1.9/16"	40	0,40	40	4	0,25	20
• 100 835 056	2"	50	0,50	50	4	0,31	20
• 100 836 066	2.3/8"	60	0,50	60	4	0,39	20
• 100 836 369	2.1/2"	63	0,55	63	4	0,43	20
• 100 837 076	2.3/4"	70	0,55	70	4	0,50	20
• 100 837 581	3"	75	0,55	75	4	0,55	20
• 100 838 086	3.5/32"	80	0,55	80	4	0,61	20
• 100 839 096	3.17/32"	90	0,55	90	4	0,71	20
• 100 831 108	4"	100	0,60	100	4	0,82	20
• 100 831 128	4.3/4"	120	0,60	120	3	0,95	20
• 100 831 138	5.1/8"	130	0,65	130	3	1,10	20
• 100 831 148	5.1/2"	140	0,65	140	3	1,23	20
• 100 831 158	6"	150	0,70	150	3	1,37	20
• 100 831 168	6.5/16"	160	0,70	160	3	1,55	20
• 100 831 188	7.1/8"	180	0,70	180	3	1,95	20
• 100 832 208	8"	200	0,80	200	3	2,15	20
• 100 832 258	10"	250	0,90	250	3	3,15	10

• Fornibile in 7 gg lavorativi / Available in 7 working days



IMPIEGO

Tubo in **poliuretano con spirale in PVC** idoneo per aspirazione di polveri e altro materiale abrasivo. **Tubo Antistatico.**

- Temperatura: -25°C +85°C

STRUTTURA

- Sottostrato: liscio in poliuretano trasparente antiabrasivo.
- Rinforzi: **spirale in PVC** rigido antiurto.
- Copertura: in poliuretano trasparente antiabrasivo.

Cordicella Rame Antistatica

APPLICATION

PVC wire polyurethane hose suitable for suction of dust and other abrasive material. **Antistatic Hose.**

- Temperature range: -25°C +85°C

CONSTRUCTION

- Tube: smooth, abrasion resistant transparent polyurethane.
- Reinforcement: **PVC wire helix**.
- Cover: abrasion resistant transparent polyurethane.

Copper Antistatic Wire



Codice Part Number	Diametro Interno Inside Diameter		Spessore Thickness	Raggio Curv. Bend Radius	Aspirazione Vacuum	Peso Weight	Lunghezza Length
	Inch.	mm					
• 100 842 529	1"	25	0,35	25	5	0,15	20
• 100 843 034	1.3/16"	30	0,35	30	5	0,19	20
• 100 844 046	1.9/16"	40	0,40	40	4	0,25	20
• 100 845 056	2"	50	0,50	50	4	0,31	20
• 100 846 066	2.3/8"	60	0,50	60	4	0,39	20
• 100 846 369	2.1/2"	63	0,50	63	4	0,43	20
• 100 847 076	2.3/4"	70	0,55	70	4	0,50	20
• 100 847 581	3"	75	0,55	75	4	0,55	20
• 100 848 086	3.5/32"	80	0,55	80	4	0,61	20
• 100 849 096	3.17/32"	90	0,55	90	4	0,71	20
• 100 841 108	4"	100	0,60	100	4	0,82	20
• 100 841 128	4.3/4"	120	0,60	120	3	0,95	20
• 100 841 158	6"	150	0,70	150	3	1,37	20

• Fornibile in 7 gg lavorativi / Available in 7 working days



IMPIEGO

Tubo in poliuretano con spirale d'acciaio ramata idoneo per aspirazione di polveri, trucioli e altro materiale abrasivo, vapori chimici, idrocarburi, olii e prodotti alimentari.

Idoneo per Spazzatrici Stradali (solo spess. 1.1)

- Temperatura: -40°C +90°C

STRUTTURA

- Sottostrato: liscio in poliuretano trasparente antiabrasivo, **spessore 0,60 mm**
- Rinforzi: **spirale in acciaio ramata.**
- Copertura: in poliuretano trasparente antiabrasivo.
- Superficie: ondulata.

APPLICATION

Copper plated steel wire **polyurethane** hose suitable for suction of dust, saw-dust and other abrasive material, chemicals steams, hydrocarbons, oils and alimentary products.

Suitable for Street Sweeper (only thickness 1.1)

- Temperature range: -40°C +90°C

CONSTRUCTION

- Tube: smooth, abrasion resistant transparent polyurethane, **thickness 0,60 mm**
- Reinforcement: **copper plated steel wire helix.**
- Cover: abrasion resistant transparent polyurethane.
- Surface: corrugated.



Codice Part Number	Diámetro Interno Inside Diameter		Spessore Thickness	Raggio Curv. Bend Radius	Aspirazione Vacuum	Peso Weight	Lunghezza Length
	Inch.	mm					
• 100 744 046	1.9/16"	40	0,60	40	0,25	0,15	15
• 100 744 551	1.3/4"	45	0,60	45	0,23	0,17	15
• 100 745 056	2"	50	0,60	50	0,20	0,19	15
• 100 746 066	2.3/8"	60	0,60	60	0,16	0,22	15
• 100 747 076	2.3/4"	70	0,60	70	0,14	0,33	15
• 100 747 682	3"	76	0,45	76	0,10	0,35	15
• 100 748 086	3.5/32"	80	0,60	80	0,10	0,37	15
• 100 749 096	3.17/32"	90	0,60	85	0,10	0,42	15
• 100 741 108	4"	100	0,60	90	0,09	0,48	15
• 100 741 118	4.5/16"	110	0,60	95	0,09	0,52	15
• 100 741 128	4.23/32"	120	0,60	102	0,09	0,55	15
• 100 741 138	5.1/8"	130	0,60	110	0,08	0,61	15
• 100 741 148	5.1/2"	140	0,60	120	0,08	0,66	15
• 100 741 158	6"	150	0,60	128	0,06	0,70	15
• 100 741 168	6.5/16"	160	0,60	136	0,06	0,75	15
• 100 741 188	7.1/8"	180	0,60	153	0,06	0,83	15
• 100 742 208	8"	200	0,60	170	0,05	0,92	15
• 100 742 212	10"	250	0,60	180	0,03	1,15	15

• Fornibile in 7 gg lavorativi / Available in 7 working days



IMPIEGO

Tubo in poliuretano con spirale d'acciaio ramata idoneo per aspirazione di polveri, trucioli e altro materiale abrasivo, vapori chimici, idrocarburi, olii e prodotti alimentari.

Idoneo per Spazzatrici Stradali (solo spess. 1.1)

- Temperatura: -40°C +90°C

STRUTTURA

- Sottostrato: liscio in poliuretano trasparente antiabrasivo, **spessore 1,10/1,75 mm**
- Rinforzi: **spirale in acciaio ramata.**
- Copertura: in poliuretano trasparente antiabrasivo.
- Superficie: ondulata.

APPLICATION

Copper plated steel wire **polyurethane** hose suitable for suction of dust, saw-dust and other abrasive material, chemicals steams, hydrocarbons, oils and alimentary products.

Suitable for Street Sweeper (only thickness 1.1)

- Temperature range: -40°C +90°C

CONSTRUCTION

- Tube: smooth, abrasion resistant transparent polyurethane, **thickness 1,10/1,75 mm.**
- Reinforcement: **copper plated steel wire helix.**
- Cover: abrasion resistant transparent polyurethane.
- Surface: corrugated.



Codice Part Number	Diámetro Interno Inside Diameter		Spessore Thickness	Raggio Curv. Bend Radius	Aspirazione Vacuum	Peso Weight	Lunghezza Length
	Inch.	mm					
• 100 754 046	1.9/16"	40	1,10	40	0,25	0,15	15
• 100 755 056	2"	50	1,10	50	0,20	0,19	15
• 100 756 066	2.3/8"	60	1,10	60	0,16	0,22	15
• 100 757 076	2.3/4"	70	1,10	70	0,14	0,33	15
• 100 758 086	3.5/32"	80	1,10	80	0,10	0,37	15
• 100 759 096	3.17/32"	90	1,10	85	0,10	0,42	15
• 100 751 108	4"	100	1,10	90	0,09	0,48	15
• 100 751 128	4.23/32"	120	1,10	102	0,09	0,55	15
• 100 751 138	5.1/8"	130	1,10	110	0,08	0,61	15
• 100 751 148	5.1/2"	140	1,10	120	0,08	0,66	15
• 100 751 158	6"	150	1,10	128	0,06	0,70	15
• 100 751 168	6.5/16"	160	1,10	136	0,06	0,75	15
• 100 751 188	7.1/8"	180	1,75	153	0,06	0,83	15
• 100 752 208	8"	200	1,75	170	0,05	0,92	15
• 100 752 210		220	1,75				15
• 100 752 212	10"	250	1,75	180	0,03	1,15	10

• Fornibile in 7 gg lavorativi / Available in 7 working days



TUBI SETTORE INDUSTRIALE
INDUSTRIAL SECTION HOSES

TUBI PER APPLICAZIONI VARIE
VARIOUS APPLICATIONS HOSES



IMPIEGO

Tubo binato in gomma long length idoneo per conduzione di **ossigeno/acetilene** nelle attrezzature di saldatura.

- Temperatura: -25°C +80°C

STRUTTURA

- Sottostrato: liscio in gomma nera.
- Rinforzi: inserzioni di filati sintetici ad alta resistenza.
- Copertura: in gomma blu (tubo ossigeno) / in gomma rossa (tubo acetilene) resistente all'abrasione, agli agenti atmosferici e al contatto di scorie di saldatura incandescenti.
- Superficie: liscia estrusa.
- Normativa: ISO 3821.

APPLICATION

Twin long length rubber hose suitable for delivery of **oxy-gen/acetylene** in welding equipments.

- Temperature range: -25°C +80°C

CONSTRUCTION

- Tube: black, smooth rubber.
- Reinforcement: high strength synthetic textile yarn.
- Cover: blue rubber (oxygen hose) / red rubber (acetylene hose), abrasion, weathering and splashes of red hot welding slags resistant.
- Surface: smooth extruded.
- According to: ISO 3821.



Codice Part Number	Diametro Interno Inside Diameter			Ø Esterno O.D.	Pr. Esercizio Max WP	Pr. Scoppio Burst Pr.	Raggio Curv. Bend Radius	Peso Weight	Lunghezza Length
	DN	Inch.	mm						
100 600 511	5	3/16"	5+5	11	20	60	40	0,23	100
100 600 613	6	1/4"	6+6	13	20	60	40	0,35	25 - 100
100 600 815	8	5/16"	8+8	15	20	60	40	0,40	25 - 100

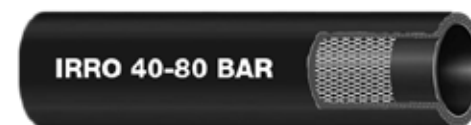

IMPIEGO

Tubo in **pvc retinato** idoneo per **irrorazione** agricola con insetticidi, pesticidi e liquidi a pressione.

- Temperatura: -10°C +60°C

STRUTTURA

- Sottostrato: liscio in pvc nero con miscela speciale.
- Rinforzi: inserzione di **filati sintetici ad alta resistenza**.
- Copertura: in pvc plastificato di colore **blu (40 e 100 bar), verde (80 bar)**, resistente agli agenti atmosferici e a gran parte dei **prodotti chimici schiume e saponi per impianti di lavaggio**.
- Superficie: liscia estrusa.

N.B. Fornibile pressato a misura con raccordi per installazione diretta su Aspo o Arrotolatore.

APPLICATION

Netted pvc hose suitable for agricultural **spraying** with insecticides, pesticides and pressurised liquids.

- Temperature range: -10°C +60°C

CONSTRUCTION

- Tube: black, smooth special compound pvc.
- Reinforcement: **high strength synthetic textile yarn**.
- Cover: **blue (40 and 100 bar), green (80 bar)**, weathering and most chemicals resistant plasticized pvc.
- Surface: smooth extruded.

N.B. Available crimped with fittings to measure for installation live on Hose Reel.



Codice Part Number	Diametro Interno Inside Diameter			Ø Esterno O.D.	Pr. Esercizio Max WP	Pr. Scoppio Burst Pr.	Peso Weight	Lunghezza Length
	DN	Inch.	mm					
100 760 814	8	5/16"	8	14,5	40	120	0,158	100
100 761 016	10	3/8"	10	16	40	120	0,185	100
100 761 321	12	1/2"	13	19	40	120	0,225	100
100 761 624	16	5/8"	16	23	40	120	0,300	50
100 761 927	19	3/4"	19	26	40	120	0,360	50
100 770 815	8	5/16"	8	15	80	240	0,185	100
100 771 018	10	3/8"	10	18	80	240	0,245	100
100 771 322	12	1/2"	13	22	80	240	0,260	100
100 781 019	10	3/8"	10	19	100	300	0,284	100
100 781 323	13	1/2"	13	23	100	300	0,392	100



IMPIEGO

Tubo in **PVC** retinato idoneo per passaggio di fluidi e schiume antincendio. **Avvolgibile su aspo e progettato per moduli antincendio e per servizio su motopompe.** Estremamente flessibile.

- Temperatura: -10°C +60°C

STRUTTURA

- Sottostrato: liscio in PVC nero.
- Rinforzi: **2 trece di filato sintetico ad alta resistenza.**
- Copertura: in PVC nero resistente all'abrasione, agli agenti atmosferici e all'invecchiamento.
- Superficie: liscia estrusa.

N.B. Fornibile pressato a misura con raccordi per installazione diretta su Aspo o Arrotolatore.

APPLICATION

PVC hose suitable for self-extinguishing foams and gases on extinguisher equipments. **Roller on hose reel and planned by fire-prevention forms and by service on motor pumps.** Extremely flexible.

- Temperature range: -10°C +60°C

CONSTRUCTION

- Tube: black, smooth PVC.
- Reinforcement: **2 high strenght syntetic textile yarn.**
- Cover: black, abrasion, weathering and agents resistant self-extinguishing pvc.
- Surface: smooth extruded.

N.B. Available crimped with fittings to measure for installation live on Hose Reel.



Codice Part Number	Diametro Interno Inside Diameter			Ø Esterno O.D.	Pr. Esercizio Max WP	Pr. Scoppio Burst Pr.	Peso Weight	Lunghezza Lenght
	DN	Inch.	mm					
100 801 018	10	3/8"	10	18	100	300	0,24	100
100 801 322	13	1/2"	13	22	100	300	0,33	100



● Fornibile in 7 gg lavorativi / Available in 7 working days



IMPIEGO

Tubo in **GOMMA** cord progettato per connessioni flessibili nei sistemi frenanti ad aria compressa dei vagoni ferroviari e locomotive. Resistenti al fuoco.

- Temperatura: -30°C +80°C

STRUTTURA

- Sottostrato: nero liscio in gomma sintetica.
- Rinforzi: tessuti sintetici ad alta resistenza.
- Copertura: nera di tela in gomma resistente agli agenti atmosferici, all'ozono, all'olio.
- Superficie: liscia ad impressione tela.
- **Normativa: UNI 4645 – SPECIFICA TRENITALIA N°373407; EN ISO 11925-2; DIN 5510-2 S3; NF F 16-101,12/13-F0 – I4.**

N.B. Fornibile assemblato a misura con raccordo di tipo ferroviario.

APPLICATION

RUBBER softwall hose suitable for flexible connection in air brake systems on rail carriages and locomotives. Fire resistant.

- Temperature range: -30°C +80°C

CONSTRUCTION

- Tube: black, smooth synthetic rubber.
- Reinforcement: high strenght syntetic cord.
- Cover: black, long lasting rubber, weathering, ozone and oil resistant.
- Surface: smooth fabric finished.
- **According to: UNI 4645 – ITALIAN RAILWAYS SPECIFICATION N°373407; EN ISO 11925-2; DIN 5510-2 S3; NF F 16-101,12/13-F0 – I4.**

N.B. Available crimped with fittings type rail to measure.



Codice Part Number	Diametro Interno Inside Diameter			Ø Esterno O.D.	Pr. Esercizio Max WP	Pr. Scoppio Burst Pr.	Peso Weight	Lunghezza Lenght
	DN	Inch.	mm					
100 999 845	28	1.7/64"	28	45	25	75	1,1	40
100 999 203	28	1.7/64"	28	45	25	75	1,1	* 0,610
100 999 440	28	1.7/64"	28	45	25	75	1,1	* 0,760

* Pezzatura fissa d'impiego con **estremità rastremate** / Supplied in applications lenght with **tapered ends**



● Fornibile in 7 gg lavorativi / Available in 7 working days

FORNIBILE A RICHIESTA - ON REQUEST



IMPIEGO

Tubo in gomma cord idoneo per mandata di acqua di raffreddamento nell'industria siderurgica e in tutti i casi in cui il tubo lavora **vicino a fonti di calore**.

- Temperatura: -40°C +120°C - Copertura in fibra di vetro resiste fino a +530°C.

STRUTTURA

- Sottostrato: liscio in **gomma EPDM bianca** elettricamente isolante in accordo **ISO8031** e resistente al calore.
- Rinforzi: tessuti sintetici ad alta resistenza.
- Copertura: Rivestimento in tessuto di **fibra di vetro**, vulcanizzato, resistente fino a **+530°C**.

N.B. I tubi possono essere forniti assemblati con differenti tipi di raccordi o flange.

APPLICATION

Softwall rubber hose suitable for delivery steel mills cooling systems and for all the operations where a resistance **to heat radiation** is required.

- Temperature range: -40°C 120°C – Fiber glass cover resists up to +530°C

CONSTRUCTION

- Tube: **white**, smooth **EPDM rubber**, electric resistant according to **ISO 8031** and heat resistant.
- Reinforcement: high strength synthetic textile plies.
- Cover: Covered with **fibre glass** that resists up to **+530°C**.

N.B. The hoses can be assembled with different types of fittings or flanges.



Codice Part Number	Diametro Interno Inside Diameter			Ø Esterno O.D.	Pr. Esercizio Max WP	Pr. Scoppio Burst Pr.	Peso Weight	Lunghezza Length
	DN	Inch.	mm					
100 201 020	10	3/8"	10	20	20	60	0,31	40
100 201 323	12	1/2"	13	23	20	60	0,40	40
100 201 626	16	5/8"	16	26	20	60	0,47	40
100 201 930	19	3/4"	19	30	20	60	0,63	40
100 202 537	25	1"	25	37	20	60	0,85	40
100 203 246	32	1.1/4"	32	46	20	60	1,24	20
100 203 858	38	1.1/2"	38	58	20	60	1,55	20
100 204 055	40	1.9/16"	40	55	20	60	1,65	10
100 205 071	50	2"	51	71	20	60	2,60	10
100 206 082	60	2.3/8"	60	82	20	60	3,46	10
100 206 386	65	2.1/2"	63.5	86	20	60	3,75	10
100 207 696	75	3"	76	96	20	60	4,71	10
100 201 120	100	4"	100	120	20	60	4,85	10
100 201 170	150	6"	150	170	20	60	5,20	10



TUBI SETTORE NAUTICO
NAUTICAL SECTION HOSES

TUBI OMOLOGATI PER NAUTICA
NAUTICAL APPROVED HOSES



GARANTITO 5 ANNI - 5 YEARS WARRANTY



IMPIEGO

Tubo in gomma long length idoneo per adduzione carburanti diesel, bio-diesel e benzine ecologiche di **motori entrobor- do su imbarcazioni da diporto fino a 24 metri.**

- Temperatura: -30° C +100° C

STRUTTURA

- Sottostrato: liscio in gomma nera NBR resistente ai carburanti con contenuto aromatico non superiore al 50%, ai bio-diesel, alle benzine ecologiche con un contenuto massimo di composti ossigenati del 15%.
- Rinforzi: inserzioni di filati sintetici ad alta resistenza.
- Copertura: in gomma nera autoestinguente CR/NBR resistente all'abrasione, al calore, ai carburanti, all'ozono ed agli agenti marini.
- Superficie: liscia estrusa.
- Normative: **ISO 7840: 2013 A1 CE.**
- Omologazione: **CE 0474 R.I.NA - LLOYD'S REGISTER.**

APPLICATION

Long length rubber hose suitable for loading diesel, bio-diesel and unleaded fuel for **marine pleasure craft inboard engines up to 24 mt length.**

- Temperature range: -30° C +100° C

CONSTRUCTION

- Tube: black, smooth, petroleum products up to 50% aromatic content resistant NBR rubber. Bio-diesel and unleaded fuel up to 15% oxygenated compound resistant.
- Reinforcement: high strength synthetic textile yarn.
- Cover: black, abrasion, heat, fuels, ozone and marine agents resistant self-extinguishing CR/NBR rubber.
- Surface: smooth extruded.
- According to: **ISO 7840: 2013 A1 CE.**
- Approved by: **CE 0474 R.I.NA - LLOYD'S REGISTER.**



Codice Part Number	Diametro Interno Inside Diameter			Ø Esterno O.D.	Pr. Esercizio Max WP	Pr. Scoppio Burst Pr.	Raggio Curv. Bend Radius	Peso Weight	Lunghezza Length
	DN	Inch.	mm						
• 100 030 616	6	1/4"	6	16	10	> 14	35	0,260	20 - 40
• 100 030 817	8	5/16"	8	17	10	> 14	50	0,270	20 - 40
• 100 031 019	10	3/8"	10	19	10	> 14	60	0,300	20 - 40
• 100 031 222	12	1/2"	12	22	10	> 10	75	0,430	20 - 40
• 100 031 626	16	5/8"	16	26	10	> 10	100	0,500	20 - 40
• 100 031 930	19	3/4"	19	30	10	> 10	115	0,640	20 - 40
• 100 042 537	25	1"	25	37	10	> 10	250	0,870	20
• 100 043 042	30	1.3/16"	30	42	10	> 10	300	1,000	20
• 100 043 244	32	1.1/4"	32	44	10	> 10	320	1,050	20
• 100 043 547	35	1.3/8"	35	47	10	> 10	350	1,150	20
• 100 043 852	38	1.1/2"	38	52	10	> 10	380	1,550	20
• 100 044 054	40	1.9/16"	40	54	10	> 10	400	1,600	20
• 100 044 559	45	1.3/4"	45	59	10	> 10	450	1,800	20
• 100 045 065	50	2"	51	65	10	> 10	500	1,950	20

• Fornibile in 7 gg lavorativi / Available in 7 working days



IMPIEGO

Tubo in gomma spiralato liscio idoneo per adduzione di carburanti diesel, bio-diesel e benzine ecologiche di **motori entrobor- do su imbarcazioni da diporto fino a 24 metri.**

- Temperatura: -30° C +100° C

STRUTTURA

- Sottostrato: liscio in gomma nera NBR resistente ai carburanti con contenuto aromatico non superiore al 50%, ai bio-diesel, alle benzine ecologiche con un contenuto massimo di composti ossigenati del 15%.
- Rinforzi: doppia spirale metallica incorporata con tessuti sintetici ad alta resistenza.
- Copertura: in gomma nera autoestinguente CR/NBR resistente all'abrasione, ai carburanti, agli olii, al calore, e agli agenti marini.
- Superficie: ondulata ad impressione tela.
- Normative: **ISO 7840: 2013 A1 CE.**
- Omologazione: **CE 0474 R.I.NA - LLOYD'S REGISTER.**

APPLICATION

Hardwall smooth cover rubber hose suitable for loading diesel, bio-diesel and unleaded fuel for **marine pleasure craft inboard engines up to 24 mt length.**

- Temperature range: -30° C +100° C

CONSTRUCTION

- Tube: black, smooth, petroleum products up to 50% aromatic content resistant NBR rubber. Bio-diesel and unleaded fuel up to 15% oxygenated compound resistant.
- Reinforcement: double steel wire helix with high strength synthetic textile plies.
- Cover: black, abrasion, fuels, oils, heat and marine agents resistant, self-extinguishing CR/NBR rubber.
- Surface: corrugated fabric finished.
- According to: **ISO 7840: 2013 A1 CE.**
- Approved by: **CE 0474 R.I.NA - LLOYD'S REGISTER.**



Codice Part Number	Diametro Interno Inside Diameter			Ø Esterno O.D.	Pr. Esercizio Max WP	Pr. Scoppio Burst Pr.	Raggio Curv. Bend Radius	Peso Weight	Lunghezza Length
	DN	Inch.	mm						
• 100 072 535	25	1"	25	35	10	> 10	40	0,520	20
• 100 073 242	32	1.1/4"	32	42	10	> 10	50	0,550	20
• 100 073 848	38	1.1/2"	38	48	10	> 10	60	0,600	20
• 100 074 050	40	1.9/16"	40	50	10	> 10	65	0,700	20
• 100 075 161	50	2"	51	61	10	> 10	75	0,800	20
• 100 076 072	60	2.3/8"	60	72	10	> 10	90	0,850	20

• Fornibile in 7 gg lavorativi / Available in 7 working days



IMPIEGO

Tubo in PVC retinato idoneo per il lavaggio delle **imbarcazioni da diporto**.

- Temperatura: -10° C +60° C

STRUTTURA

- Sottostrato: liscio in **PVC blu** atossico **antialga**.
- Rinforzi: inserzione di **filati sintetici** ad alta resistenza anti torsione.
- Copertura: in **PVC bianco** resistente agli agenti marini, ai detergenti ed a gran parte dei prodotti chimici.
- Superficie: liscia estrusa.

APPLICATION

Netted PVC hose suitable for wash down services on **marine pleasure crafts**.

- Temperature range: -10° C +60° C

CONSTRUCTION

- Tube: **blu**, smooth non-toxic and **algae-free PVC** compound.
- Reinforcement: high strength **synthetic textile yarn** torsion free.
- Cover: weathering and most chemicals resistant **white PVC**.
- Surface: smooth extruded.



Codice Part Number	Diametro Interno Inside Diameter		Ø Esterno O.D.	Pr. Esercizio Max WP	Raggio Curv. Bend Radius	Peso Weight	Lunghezza Length
	DN	Inch. mm					
100 221 217	12	1/2" 12/13	17	5	95	0,13	25
100 221 621	16	5/8" 15/16	21	5	120	0,19	25
100 221 925	19	3/4" 19/20	25	5	160	0,29	25 - 50
100 222 532	25	1" 25	32	5	200	0,44	25 - 50
100 031 626	16	5/8" 16	26	10	100	0,500	20 - 40
100 031 930	19	3/4" 19	30	10	115	0,640	20 - 40



● Fornibile in 7 gg lavorativi / Available in 7 working days



IMPIEGO

Tubo in gomma spiralato liscio idoneo per aspirazione a mandata di acqua calda e **acqua di mare**.

- Temperatura: -40° C +120° C

STRUTTURA

- Sottostrato: liscio in gomma nera EPDM resistente al calore.
- Rinforzi: **spirale metallica incorporata** con tessuti sintetici ad alta resistenza.
- Copertura: in gomma nera EPDM resistente all'abrasione, al calore, all'acqua di mare, agli agenti atmosferici e all'ozono.
- Superficie: liscia ad impressione tela.

APPLICATION

Hardwall smooth cover rubber hose suitable for suction and delivery of hot water and **sea water**.

- Temperature range: -40° C +120° C

CONSTRUCTION

- Tube: black, smooth, heat resistant EPDM rubber.
- Reinforcement: **steel wire helix** with high strength synthetic textile plies.
- Cover: black, abrasion, heat, sea water, weathering and ozone resistant EPDM rubber.
- Surface: smooth, fabric finished.



Codice Part Number	Diametro Interno Inside Diameter		Ø Esterno O.D.	Pr. Esercizio Max WP	Pr. Scoppio Burst Pr.	Raggio Curv. Bend Radius	Aspirazione Vacuum	Peso Weight	Lunghezza Length
	Inch.	mm							
100 231 626	5/8"	16	26	10	30	95	0,9	0,50	60
100 232 030	25/32"	20	30	10	30	120	0,9	0,55	60
100 232 535	1"	25	35	10	30	150	0,9	0,69	60
100 233 040	1.3/16"	30	40	10	30	180	0,9	0,77	60
100 233 243	1.1/4"	32	43	10	30	190	0,9	0,95	60
100 233 546	1.3/8"	35	46	10	30	210	0,9	1,08	60
100 233 849	1.1/2"	38	49	10	30	230	0,9	1,20	60
100 234 051	1.9/16"	40	51	10	30	240	0,9	1,30	60
100 235 063	2"	51	63	10	30	310	0,9	1,75	60

● Fornibile in 7 gg lavorativi / Available in 7 working days



IMPIEGO

Tubo in **PVC con spirale in PVC** utilizzato per collegamenti scarico WC su imbarcazioni.

Limita la propagazione degli odori.

- Temperatura: -10° C +60° C

STRUTTURA

- Sottostrato: liscio in **PVC bianco**.
- Rinforzi: spirale **PVC** rigida antiurto.
- Copertura: in **PVC bianco** resistente agli agenti marini, ai detergenti ed a gran parte dei prodotti chimici.
- Superficie: liscia.

APPLICATION

PVC wire PVC hose designed as sewage pipe for marine toilets.

It limits the spreading of odours.

- Temperature range: -10° C +60° C

CONSTRUCTION

- Tube: **white**, smooth **PVC**.
- Reinforcement: **PVC** wire helix.
- Cover: weathering and most chemicals resistant **white PVC**.
- Surface: smooth.



Codice Part Number	Diametro Interno Inside Diameter		Ø Esterno O.D.	Pr. Esercizio Max WP	Pr. Scoppio Burst Pr.	Raggio Curv. Bend Radius	Aspirazione Vacuum	Peso Weight	Lunghezza Length
	Inch.	mm	mm.	bar	bar	mm.	bar	Kg./mt.	mt.
• 100 851 622	5/8"	16	22	7	23	60	0,7	0,22	30
• 100 852 026	3/4"	20	26,4	7	23	100	0,7	0,30	30
• 100 852 532	1"	25	32,6	7	23	110	0,7	0,46	30
• 100 853 846	1.1/2"	38	46	6	18	180	0,7	0,67	30



• Fornibile in 7 gg lavorativi / Available in 7 working days



IMPIEGO

Tubo in **PVC con spirale in PVC** utilizzato per collegamenti scarico WC su imbarcazioni.

Limita la propagazione degli odori.

- Temperatura: -10° C +60° C

STRUTTURA

- Sottostrato: liscio in **PVC bianco**.
- Rinforzi: **spirale ACCIAIO**.
- Copertura: in **PVC bianco** resistente agli agenti marini, ai detergenti ed a gran parte dei prodotti chimici.
- Superficie: liscia.

APPLICATION

PVC wire PVC hose designed as sewage pipe for marine toilets.

It limits the spreading of odours.

- Temperature range: -10° C +60° C

CONSTRUCTION

- Tube: **white**, smooth **PVC**.
- Reinforcement: **STEEL** wire helix.
- Cover: weathering and most chemicals resistant **white PVC**.
- Surface: smooth.



Codice Part Number	Diametro Interno Inside Diameter		Ø Esterno O.D.	Pr. Esercizio Max WP	Pr. Scoppio Burst Pr.	Raggio Curv. Bend Radius	Aspirazione Vacuum	Peso Weight	Lunghezza Length
	Inch.	mm	mm.	bar	bar	mm.	bar	Kg./mt.	mt.
• 100 861 623	5/8"	16	23	6	18	35	0,8	0,30	30
• 100 862 027	25/32"	20	27	5	15	50	0,8	0,32	30
• 100 862 533	1"	25	33	5	15	75	0,8	0,55	30
• 100 863 038	1.3/16"	30	38	4,5	13,5	90	0,8	0,60	30
• 100 863 241	1.1/4"	32	41	4,5	13,5	95	0,8	0,70	30
• 100 863 848	1.1/2"	38	48	4	12	115	0,8	0,90	30
• 100 864 050	1.9/16"	40	50	4	12	120	0,8	0,98	30
• 100 865 061	2"	50	61	3,5	10,5	150	0,8	1,40	30
• 100 866 073	2.3/8"	60	73	3	9	180	0,7	2,00	30

• Fornibile in 7 gg lavorativi / Available in 7 working days



IMPIEGO

Tubo in **gomma spiralato liscio** idoneo per aspirazione a mandata di acqua calda e **acqua di mare**. Utilizzato per collegamenti scarico WC su imbarcazioni e pompe di sentina.

Limita la propagazione degli odori.

- Temperatura: -30° C + 80° C

STRUTTURA

- Sottostrato: liscio in **gomma nera**.
- Rinforzi: **spirale metallica incorporata** con tessuti sintetici ad alta resistenza.
- Copertura: in gomma bianca resistente all'abrasione, all'acqua di mare, agli agenti atmosferici.
- Superficie: liscia ad impressione tela.

APPLICATION

Hardwall smooth cover **rubber hose** suitable for suction and delivery of hot water and **sea water**.

Designed as sewage pipe for marine toilets and bilge pumps.

It limits the spreading of odours.

- Temperature range: -30° C + 80° C

CONSTRUCTION

- Tube: **black, smooth rubber**.
- Reinforcement: **steel wire helix** with high strength synthetic textile plies.
- Cover: white, abrasion, sea water, weathering resistant rubber.
- Surface: smooth, fabric finished.



Codice Part Number	Diametro Interno Inside Diameter		Ø Esterno O.D.	Pr. Esercizio Max WP	Pr. Scoppio Burst Pr.	Raggio Curv. Bend Radius	Aspirazione Vacuum	Peso Weight	Lunghezza Length
	Inch.	mm	mm.	bar	bar	mm.	bar	Kg./mt.	mt.
100 871 626	5/8"	16	26	7	21	65	0,9	0,56	30,5
100 871 929	3/4"	19	29	7	21	75	0,9	0,70	30,5
100 872 535	1"	25	35	7	21	100	0,9	0,75	30,5
100 873 040	1.3/16"	30	40	7	21	120	0,9	0,93	25
100 873 848	1.1/2"	38	48	7	21	150	0,9	1,15	30,5

• Fornibile in 7 gg lavorativi / Available in 7 working days



GARANTITO 5 ANNI - 5 YEARS WARRANTY



IMPIEGO

Tubo in **gomma spiralato liscio** idoneo per aspirazione a mandata di acqua calda e **acqua di mare**.

SUPER FLESSIBILE

Utilizzato per collegamenti scarico WC su imbarcazioni e pompe di sentina.

Limita la propagazione degli odori.

- Temperatura: -40° C + 120° C

STRUTTURA

- Sottostrato: liscio in gomma butilica **BIANCA** con **livello di permeabilità inferiore all'1%**.
- Rinforzi: **DOPPIA spirale metallica incorporata** con tessuti sintetici ad alta resistenza.
- Copertura: in gomma speciale **bianca PROFUMATA** resistente all'abrasione, all'acqua di mare, agli agenti atmosferici e all' OZONO.
- Superficie: liscia ad impressione tela.
- **NORMATIVE: F.D.A. - ISO 8099:2000**

APPLICATION

Hardwall smooth cover **rubber hose** suitable for suction and delivery of hot water and **sea water**.

EXTREMELY FLEXIBLE

Designed as sewage pipe for marine toilets bilge pumps.

It limits the spreading of odours.

- Temperature range: -40° C + 120° C

CONSTRUCTION

- Tube: **WHITE**, smooth BUTYL rubber with **permeability level lower than 1%**.
- Reinforcement: **steel wire DOUBLE helix** with high strength synthetic textile plies.
- Cover: **white PERFUMED**, abrasion, sea water, weathering and OZONE resistant rubber.
- Surface: smooth, fabric finished.
- **STANDARDS: F.D.A. - ISO 8099:2000**



Codice Part Number	Diametro Interno Inside Diameter		Ø Esterno O.D.	Pr. Esercizio Max WP	Pr. Scoppio Burst Pr.	Raggio Curv. Bend Radius	Aspirazione Vacuum	Peso Weight	Lunghezza Length
	Inch.	mm	mm.	bar	bar	mm.	bar	Kg./mt.	mt.
100 881 626	5/8"	16	26	7	21	35	0,9	0,45	30,5
100 881 929	3/4"	19	29	7	21	40	0,9	0,48	30,5
100 882 535	1"	25	35	7	21	50	0,9	0,52	30,5
100 883 040	1.3/16"	30	40	7	21	60	0,9	0,67	30,5
100 883 848	1.1/2"	38	48	7	21	80	0,9	0,85	30,5
100 884 050	1.9/16"	40	50	7	21	85	0,9	0,89	30,5
100 885 161	2"	51	61	7	21	100	0,9	1,11	30,5

• Fornibile in 7 gg lavorativi / Available in 7 working days



IMPIEGO

Tubo in gomma spiralato ondulato idoneo per scarico gas combustibili e raffreddamento degli scambiatori di calore sulle imbarcazioni da diporto entro i 24 mt. La particolare struttura consente di effettuare raggi di curvatura da 1 a 1.5 volte il diametro interno.

- Temperatura: -30°C +100°C

STRUTTURA

- Sottostrato: liscio in gomma nera resistente ai gas combustibili e all'acqua di mare.
- Rinforzi: doppia spirale metallica incorporata con filati sintetici ad alta resistenza.
- Copertura: in gomma nera resistente all'abrasione al calore, ed agli agenti marini.
- Superficie: ondulata ad impressione tela.
- Normativa: SAE J 2006:2003 R2 - ISO 13363:2004 Tipo 2 Classe B.
- Omologazione: LLOYD'S REGISTER N.96/00127 - R.I.N.A. N. DIP 075110CS.

APPLICATION

Hardwall corrugated cover marine exhaust rubber hose suitable also for cooling the heat exchangers on pleasure boats up to 24 mt. The construction ensures bending radius up to 1/1.5 for the inside diameter.

- Temperature range: -30°C +100°C

CONSTRUCTION

- Tube: black, smooth marine exhaust and sea water resistant rubber.
- Reinforcement: double steel wire helix with high strength synthetic textile yarn.
- Cover: black, abrasion, heat and marine agents resistant rubber.
- Surface: corrugated fabric finished.
- According to: SAE J 2006:2003 R2 - ISO 13363:2004 Tipo 2 Classe B.
- Approved: LLOYD'S REGISTER N.96/00127 - R.I.N.A. N. DIP 075110CS.



Codice Part Number	Diametro Interno Inside Diameter		Ø Esterno O.D.	Pr. Esercizio Max WP	Pr. Scoppio Burst Pr.	Raggio Curv. Bend Radius	Peso Weight	Lunghezza Length
	DN	Inch. mm						
100 632 535	25	1" 25	33	3	9	25	0,61	20
100 633 040	30	1.3/16" 30	38	3	9	30	0,68	20
100 633 242	32	1.1/4" 32	40	3	9	32	0,76	20
100 633 545	35	1.3/8" 35	43	3	9	35	0,82	20
100 633 848	38	1.1/2" 38	46	3	9	38	0,88	20
100 634 050	40	1.9/16" 40	48	3	9	40	0,92	20
100 634 555	45	1.3/4" 45	53	3	9	45	1,10	20
100 635 161	50	2" 51	61	3	9	51	1,16	20
100 635 560	55	2.5/32" 55	65	3	9	55	1,25	20
100 636 070	60	2.3/8" 60	70	3	9	60	1,35	20
100 636 375	63	2.1/2" 63,5	73,5	3	9	63,5	1,60	20
100 637 082	70	2.3/4" 70	80	3	9	70	1,72	20
100 637 688	76	3" 76	86	3	9	76	1,95	20

SEGUE A PAG. 155 / Follow to pag. 155



IMPIEGO

Tubo in gomma spiralato ondulato idoneo per scarico gas combustibili e raffreddamento degli scambiatori di calore sulle imbarcazioni da diporto entro i 24 mt. La particolare struttura consente di effettuare raggi di curvatura da 1 a 1.5 volte il diametro interno.

- Temperatura: -30°C +100°C

STRUTTURA

- Sottostrato: liscio in gomma nera resistente ai gas combustibili e all'acqua di mare.
- Rinforzi: doppia spirale metallica incorporata con filati sintetici ad alta resistenza.
- Copertura: in gomma nera resistente all'abrasione al calore, ed agli agenti marini.
- Superficie: ondulata ad impressione tela.
- Normativa: SAE J 2006:2003 R2 - ISO 13363:2004 Tipo 2 Classe B.
- Omologazione: LLOYD'S REGISTER N.96/00127 - R.I.N.A. N. DIP 075110CS.

APPLICATION

Hardwall corrugated cover marine exhaust rubber hose suitable also for cooling the heat exchangers on pleasure boats up to 24 mt. The construction ensures bending radius up to 1/1.5 for the inside diameter.

- Temperature range: -30°C +100°C

CONSTRUCTION

- Tube: black, smooth marine exhaust and sea water resistant rubber.
- Reinforcement: double steel wire helix with high strength synthetic textile yarn.
- Cover: black, abrasion, heat and marine agents resistant rubber.
- Surface: corrugated fabric finished.
- According to: SAE J 2006:2003 R2 - ISO 13363:2004 Tipo 2 Classe B.
- Approved: LLOYD'S REGISTER N.96/00127 - R.I.N.A. N. DIP 075110CS.



Codice Part Number	Diametro Interno Inside Diameter		Ø Esterno O.D.	Pr. Esercizio Max WP	Pr. Scoppio Burst Pr.	Raggio Curv. Bend Radius	Peso Weight	Lunghezza Length
	DN	Inch. mm						
100 638 092	80	3.5/32" 80	90	3	9	80	2,10	20
100 639 102	90	3.17/32" 90	100	3	9	90	2,50	20
100 631 116	100	4" 102	112	3	9	152	2,96	20
100 631 125	110	4.1/2" 110	122	3	9	220	3,20	20
100 631 134	120	4.3/4" 120	132	3	9	240	3,45	20
100 631 141	127	5" 127	139	3	9	255	3,65	10 - 20
100 631 144	130	5.1/8" 130	142	3	9	260	3,80	20
100 631 158	140	5.19/32" 142	154	3	9	285	4,10	10
100 631 168	150	6" 152	164	3	9	305	4,20	10 - 20
100 631 171	155	6.1/8" 155	169	3	9	465	4,50	10
100 631 190	175	7" 175	191	3	9	525	6,20	10
100 632 220	200	8" 203	219	3	9	815	6,90	10 - 20
100 632 272	250	10" 254	272	3	9	1270	8,50	10
100 633 325	300	12" 305	325	3	9	1830	10,90	10



IMPIEGO

Tubo in gomma spiraleto **idoneo per scarico gas combustibili e raffreddamento degli scambiatori di calore sulle imbarcazioni da diporto entro i 24 mt.**

- Temperatura: -30°C +100°C

STRUTTURA

- Sottostrato: liscio in gomma nera resistente ai gas combustibili ed all'acqua di mare.
- Rinforzi: doppia spirale metallica incorporata con filati sintetici ad alta resistenza.
- Copertura: in gomma nera resistente all'abrasione al calore, ed agli agenti marini.
- **Superficie: liscia ad impressione tela.**
- Normativa: **SAE J 2006:2003 R2 - ISO 13363:2004 Tipo 2 Classe B.**
- Omologazione: **LLOYD'S REGISTER N.96/00126 - R.I.N.A. N. DIP 075110CS.**

APPLICATION

Hardwall corrugated cover **marine exhaust rubber hose suitable also for cooling the heat exchangers on pleasure boats up to 24 mt.** The construction ensures bending radius up to 1/1.5 for the inside diameter.

- Temperature range: -30°C +100°C

CONSTRUCTION

- Tube: black, smooth, marine exhaust and sea water resistant rubber.
- Reinforcement: double steel wire helix with high strength synthetic textile yarn.
- Cover: black, abrasion, heat, and marine agents resistant rubber.
- **Surface: smooth fabric finished.**
- According to: **SAE J 2006:2003 R2 - ISO 13363:2004 Tipo 2 Classe B.**
- Approved: **LLOYD'S REGISTER N.96/00126 - R.I.N.A. N. DIP 075110CS.**



Codice Part Number	Diametro Interno Inside Diameter			Ø Esterno O.D.	Pr. Esercizio Max WP	Pr. Scoppio Burst Pr.	Raggio Curv. Bend Radius	Peso Weight	Lunghezza Length
	DN	Inch.	mm						
• 100 641 928	19	3/4"	19	28	3	> 10	57	0,44	20
• 100 642 534	25	1"	25	34	3	> 10	75	0,50	30,5
• 100 643 039	30	1.3/16"	30	39	3	> 10	90	0,58	30,5
• 100 643 241	32	1.1/4"	32	41	3	> 10	96	0,62	30,5
• 100 643 544	35	1.3/8"	35	44	3	> 10	105	0,66	30,5
• 100 643 847	38	1.1/2"	38	47	3	> 10	114	0,72	30,5
• 100 644 049	40	1.9/16"	40	49	3	> 10	120	0,75	30,5
• 100 644 554	45	1.3/4"	45	54	3	> 10	135	0,84	30,5
• 100 645 161	50	2"	51	61	3	> 10	150	0,96	30,5
• 100 646 070	60	2.3/8"	60	70	3	> 10	180	1,35	30,5
• 100 646 373	63	2.1/2"	63,5	73	3	> 10	190	1,48	30,5
• 100 647 686	76	3"	76	86	3	> 10	225	2,15	30,5
• 100 648 090	80	3.5/32"	80	90	3	> 10	240	2,25	30,5
• 100 649 100	90	3.17/32"	90	100	3	> 10	270	2,62	30,5
• 100 641 110	100	4"	102	110	3	> 10	280	2,95	20

• Fornibile in 7 gg lavorativi / Available in 7 working days



TUBI TRECCIATI
BRAIDS HOSES

TUBI TRECCIATI ESTERNAMENTE
EXTERNAL BRAIDS HOSES



IMPIEGO

TUBO ALTA PRESSIONE 1SN per olii idraulici, minerali e „biologici“, olii a base poliglicole, acqua, emulsioni olio/acqua.

- Temperatura: -40°C +100°C con punte di 120°C

STRUTTURA

- Sottostrato: liscio in gomma nera sintetica oleoresistente.
- Rinforzi: **1 treccia acciaio alta resistenza.**
- Copertura: gomma sintetica con ottima resistenza all'abrasione, ozono, olio ed all'invecchiamento.
- Rivestimento esterno: **treccia in acciaio zincato.**
- Normative: ISO 1436 / DIN EN 853 – 1SN / SAE J517 - SAE 100 R1AT

APPLICATION

HIGH PRESSURE 1SN HOSE for hydraulic mineral and „biological“ oils, polyglycol base oil, water, oil/water emulsions.

- Temperature range: -40°C +100°C peak of +120°C

CONSTRUCTION

- Tube: black, smooth, resistant synthetic rubber.
- Reinforcement: **1 high tensile steel wire braid.**
- Cover: abrasion, weather, ozone and oil resistant synthetic black rubber.
- External covering: **galvanized steel braid.**
- According to: ISO 1436 / DIN EN 853 – 1 SN / SAE J517 - SAE 100 R1AT



Codice Part Number	Diametro Interno Inside Diameter			Ø Esterno O.D.	Pr. Esercizio Max WP	Pr. Scoppio Burst Pr.	Raggio Curv. Bend Radius	Peso Weight	Boccola Ferrule	Lunghezza Lenght
	DN	Inch.	mm							
• 100 951 140	6	1/4"	6,3	14,4	225	900	100	0,330	014 120 140	50
• 100 951 516	8	5/16"	8	16	215	850	114	0,390	014 120 516	50
• 100 951 380	10	3/8"	9,5	18,4	180	720	127	0,480	014 120 380	50
• 100 951 120	12	1/2"	12,7	21,6	160	640	178	0,590	014 120 120	50
• 100 951 580	16	5/8"	16	24,7	130	520	200	0,680	014 120 580	50
• 100 951 340	19	3/4"	19	28,7	105	420	240	0,840	014 120 340	50
• 100 951 100	25	1"	25,4	36,6	88	350	300	1,020	014 120 100	50
• 100 951 114	31	1.1/4"	32	44,7	63	250	419	1,610	014 120 114	40
• 100 951 112	38	1.1/2"	38	51,2	50	200	500	1,880	014 120 112	40
• 100 951 200	50	2"	50,8	64,8	40	160	630	2,530	014 120 200	40

• Fornibile in 7 gg lavorativi / Available in 7 working days



IMPIEGO

TUBO ALTA PRESSIONE 2SC per olii idraulici, minerali e „biologici“, olii a base poliglicole, acqua, emulsioni olio/acqua.

- Temperatura: -40°C +100°C con punte di 120°C

STRUTTURA

- Sottostrato: liscio in gomma nera sintetica oleoresistente.
- Rinforzi: **2 treccie acciaio alta resistenza.**
- Copertura: gomma sintetica con ottima resistenza all'abrasione, ozono, olio ed all'invecchiamento.
- Rivestimento esterno: **treccia in acciaio zincato.**
- Normative: ISO 11237-1 / DIN EN 857 – 2SC

APPLICATION

HIGH PRESSURE 2SC HOSE for hydraulic mineral and „biological“ oils, polyglycol base oil, water, oil/water emulsions.

- Temperature range: -40°C +100°C peak of +120°C

CONSTRUCTION

- Tube: black, smooth, resistant synthetic rubber.
- Reinforcement: **2 high tensile steel wire braids.**
- Cover: abrasion, weather, ozone and oil resistant synthetic black rubber.
- External covering: **galvanized steel braid.**
- According to: ISO 11237-1 / DIN EN 857 – 2SC



Codice Part Number	Diametro Interno Inside Diameter			Ø Esterno O.D.	Pr. Esercizio Max WP	Pr. Scoppio Burst Pr.	Raggio Curv. Bend Radius	Peso Weight	Boccola Ferrule	Lunghezza Lenght
	DN	Inch.	mm							
• 100 952 140	6	1/4"	6,4	14,4	400	1600	75	0,390	014 120 140	25 - 50
• 100 952 516	8	5/16"	7,9	16,2	350	1400	85	0,460	014 120 516	50
• 100 952 380	10	3/8"	9,6	18,3	330	1320	90	0,550	014 120 380	25 - 50
• 100 952 120	12	1/2"	12,7	21,7	275	1100	130	0,740	014 120 120	25 - 50
• 100 952 580	16	5/8"	15,9	25,0	250	1000	170	0,910	014 120 580	50
• 100 952 340	19	3/4"	19	29,0	215	860	200	1,070	014 120 340	50
• 100 952 100	25	1"	25,4	36,7	165	660	250	1,510	014 120 100	50

• Fornibile in 7 gg lavorativi / Available in 7 working days

▲ Taglio a misura applicato sovrapprezzo di 15,00 euro / Cut To Size Applied Supplement of 15 Euro



IMPIEGO

Trafilato in P.T.F.E. trecciato in acciaio inox idoneo per impianti idraulici, circuiti di lubrificazione, passaggio carburanti, sistemi frenanti, aria compressa, gas, prodotti chimici, prodotti alimentari, prodotti farmaceutici e vapori a alta temperatura.

- Temperatura: -60°C +205°C/220°C

STRUTTURA

- Sottostrato: **P.T.F.E.** estruso.
- Rinforzi/Copertura: trecciatura di filo acciaio inox **AISI 304**.
- Superficie: trecciata.

La misura di 1/8" idoneo per tubi freno.

APPLICATION

Stainless wire braided one-layer P.T.F.E. hose suitable for hydraulic and lubricant system, fuel, brake system, compressed air, gas, chemical products, alimentary products, pharmaceutical products and steam high temperature delivery.

- Temperature range: -60°C +205°C/220°C

CONSTRUCTION

- Tube: **P.T.F.E.** one-layer.
- Reinforcement/Cover: stainless **AISI 304** wire braid.
- Surface: braided.

The 1/8" diameter suitable for brake hose



Codice Part Number	Diametro Interno Inside Diameter		Ø Esterno O.D.	Pr. Esercizio Max WP	Pr. Scoppio Burst Pr.	Raggio Curv. Bend Radius	Peso Weight	Boccola Ferrule	Lunghezza Length	
	DN	Inch. mm								mm.
100 810 507	5	3/16"	4,8	7,6	190	760	50	0,690	014 900 316	> 10
100 810 609	6	1/4"	6,35	8,8	180	720	75	0,870	014 900 140	> 10
• 100 810 811	8	5/16"	8	11,0	175	700	100	0,127	014 900 515	> 10
100 810 912	10	3/8"	9,5	12,1	165	660	125	0,145	014 900 380	> 10
100 811 316	13	1/2"	12,7	16,2	120	480	165	0,212	014 900 120	> 10
100 811 619	16	5/8"	16	18,8	88	352	200	0,260	014 900 580	> 10
• 100 811 922	19	3/4"	19	23,1	70	280	230	0,321	014 900 340	> 10
100 812 530	25	1"	25,4	29,2	60	240	300	0,450	014 900 100	> 10
• 100 951 112	38	1.1/2"	38	51,2	50	200	500	1,880	014 120 112	40

• Fornibile in 7 gg lavorativi / Available in 7 working days



IMPIEGO

Trafilato in P.T.F.E. CORRUGATO in acciaio inox idoneo per impianti idraulici, circuiti di lubrificazione, passaggio carburanti, aria compressa, gas, prodotti chimici, prodotti alimentari, prodotti farmaceutici e vapori a alta temperatura.

- Temperatura: -60°C +230°C

STRUTTURA

- Sottostrato: **P.T.F.E. corrugato**.
- Rinforzi/Copertura: trecciatura di filo acciaio inox alta tenacità **AISI 304**.
- Superficie: trecciata.
- Caratteristiche: **bassa permeabilità ed elevata flessibilità per applicazioni con raggi di curvatura ridotti.**

APPLICATION

CONVOLUTED stainless wire braided one-layer P.T.F.E. hose suitable for hydraulic and lubricant system, fuel, compressed air, gas, chemical products, alimentary products, pharmaceutical products and steam high temperature delivery.

- Temperature range: -60°C +230°C

CONSTRUCTION

- Tube: **convoluted P.T.F.E.**
- Reinforcement/Cover: stainless **AISI 304** wire braid.
- Surface: braided.
- Features: **low permeability and high flexibility for lower bending radius applications.**



Codice Part Number	Diametro Interno Inside Diameter		Ø Esterno O.D.	Pr. Esercizio Max WP	Pr. Scoppio Burst Pr.	Raggio Curv. Bend Radius	Peso Weight	Boccola Ferrule	Lunghezza Length	
	DN	Inch. mm								mm.
• 100 820 915	10	3/8"	8,99	12,95	138	414	22	0,212	014 990 380	a richiesta
• 100 821 217	13	1/2"	12,45	18,16	103	310	25	0,303	014 990 120	a richiesta
• 100 821 521	16	5/8"	15,37	21,59	83	248	51	0,361	014 990 580	a richiesta
• 100 821 825	19	3/4"	18,54	24,0	69	207	64	0,430	014 990 340	a richiesta
• 100 822 431	25	1"	24,89	32,13	46	138	89	0,653	014 990 100	a richiesta
• 100 823 139	32	1.1/4"	31,95	40,21	34	103	125	0,750	014 990 114	a richiesta
• 100 823 644	38	1.1/2"	39,12	49,02	30	90	150	0,800	014 990 112	a richiesta
• 100 824 958	51	2"	49,91	59,18	23	69	200	0,950	014 990 200	a richiesta

• Fornibile in 7 gg lavorativi / Available in 7 working days



IMPIEGO

Trafilato in gomma trecciata in acciaio zincato idoneo per mandata di olii minerali, lubrificanti, gasolio e carburanti.

- Temperatura: -20° C +90° C

STRUTTURA

- Sottostrato: trafileto monoestruso liscio in gomma nera NBR, resistente a prodotti petroliferi con contenuto aromatico non superiore del 40%.
- Rinforzi/Copertura: **trecciatura di filo acciaio zincato con filo di identificazione nero e rosso.**
- Superficie: trecciata.

Disponibile su richiesta: trecciatura in acciaio INOX.

APPLICATION

Galvanized steel wire braided cover one-layer rubber hose, suitable for loading oils, lubricant, diesel and fuels.

- Temperature range: -20° C +90° C

CONSTRUCTION

- Tube: black, smooth, petroleum product up to 40% aromatic content resistant NBR rubber.
- Reinforcement/Cover: **galvanized steel wire braid with black and red strip.**
- Surface: braided.

Available on request: stainless steel wire braid cover.



Codice Part Number	Diametro Interno Inside Diameter			Ø Esterno O.D.	Pr. Esercizio Max WP	Pr. Scoppio Burst Pr.	Raggio Curv. Bend Radius	Peso Weight	Lunghezza Length
	DN	Inch.	mm						
• 100 110 611	6	1/4"	6	11	25	75	30	0,160	100
• 100 110 813	8	5/16"	8	13	25	75	40	0,230	25 - 100
• 100 111 015	10	3/8"	10	15	25	75	50	0,280	25 - 100
• 100 111 319	12	1/2"	13	19	20	60	65	0,380	25 - 100
• 100 111 622	16	5/8"	16	22	20	60	80	0,460	100
• 100 111 925	19	3/4"	19	25	15	45	95	0,570	50
• 100 112 533	25	1"	25	33	15	45	125	0,660	50

• Fornibile in 7 gg lavorativi / Available in 7 working days



IMPIEGO

Trafilato in gomma tracciata in acciaio zincato idoneo per mandata di acqua calda e liquidi non corrosivi.

- Temperatura: -30° C +100° C

STRUTTURA

- Sottostrato: liscio in gomma nera EPDM, resistente al calore. Durezza Shore A: 80 ± 5
- Rinforzi/Copertura: tracciatura di filo acciaio zincato con due fili di identificazione: rosso e blu.
- Superficie: trecciata.

N.B. Fornibile a richiesta con trecciatura in calza acciaio inox.

APPLICATION

Galvanized steel wire braided one-layer rubber hose suitable for hot water and non corrosive liquids.

- Temperature range: -30° C +100° C

CONSTRUCTION

- Tube: black, smooth, heat resistant EPDM rubber. Hard- ness Shore A: 80 ± 5
- Reinforcement/Cover: galvanized steel wire braid with two stripe: red and blue.
- Surface: braided.

Available on request with stainless wire braided cover.



Codice Part Number	Diametro Interno Inside Diameter			Ø Esterno O.D.	Pr. Esercizio Max WP	Pr. Scoppio Burst Pr.	Raggio Curv. Bend Radius	Peso Weight	Boccola Ferrule	Lunghezza Length
	DN	Inch.	mm							
• 100 341 015	10	3/8"	10	15	25	75	100	0,25	100	a richiesta
• 100 341 319	12	1/2"	13	19	25	75	130	0,40	100	a richiesta
• 100 341 623	16	5/8"	16	23	20	60	160	0,49	50	a richiesta
• 100 341926	19	3/4"	19	26	20	60	190	0,58	50	a richiesta
• 100 342 533	25	1"	25	33	15	45	250	0,80	50	a richiesta
• 100 343 243	32	1.1/4"	32	43	10	30	320	1,13	40	a richiesta
• 100 343 851	38	1.1/2"	38	51	10	30	380	1,52	30	a richiesta
• 100 344 053	40	1.9/16"	40	53	10	30	400	1,57	30	a richiesta
• 100 345 064	50	2"	50/51	64	10	30	510	2,01	20	

• Fornibile in 7 gg lavorativi / Available in 7 working days

FORNIBILE A RICHIESTA - ON REQUEST



IMPIEGO

Trafilato in gomma trecciato in acciaio zincato idoneo per mandata di gas metano, di ossigeno e altri gas inerti.

- Temperatura: -30°C +100°C

STRUTTURA

- Sottostrato: trafilato monoestruso liscio in gomma nera autoestingente CR. Conduttività elettrica 3x108 Ω. Durezza Shore A 75 ± 5.
- Rinforzi/Copertura: trecciatura di filo acciaio zincato con filo di identificazione giallo.
- Superficie: trecciata.
- **Normativa: ASTM C542.**

APPLICATION

Galvanized steel wire braid cover one-layer rubber hose suitable for loading methane, oxygen and other inert gases.

- Temperature range: -30°C +100°C

CONSTRUCTION

- Tube: one-layer, black, smooth self-extinguishing CR rubber. Electrical conductivity 3x108 Ω. Shore A 75 ± hard-ness.
- Reinforcement/Cover: galvanized steel wire braid with yellow stripe.
- Surface: braided finished.
- **According to: ASTM C542.**



Codice Part Number	Diametro Interno Inside Diameter			Ø Esterno O.D.	Pr. Esercizio Max WP	Pr. Scoppio Burst Pr.	Raggio Curv. Bend Radius	Peso Weight	Lunghezza Lenght
	DN	Inch.	mm						
100 621 320	12	1/2"	13	20	10	30	80	0,40	100
100 621 930	19	3/4"	19	30	10	30	120	0,80	40
100 622 536	25	1"	25	36	20	60	150	0,95	30,5



● Fornibile in 7 gg lavorativi / Available in 7 working days

**TUBI FLESSIBILI
INOX**



DESCRIZIONE

I tubi metallici flessibili ondulati garantiscono una perfetta tenuta alla pressione, con un'elevata flessibilità assicurata dalla deformazione della parete ondulata. In funzione delle condizioni d'esercizio sono muniti di una o più trecce atte a resistere alla pressione in essi esercitata.

I tubi ondulati sono ricavati da lamiere di spessore sottilissimo saldate mediante metodo testa-testa o a sovrapposizione.

DESCRIPTION

The corrugated flexible steel hoses are perfect to resist to high pressure with high flexibility thanks to very high flexibility of corrugated inside wall. To increase the pressure resisting it can be supplied with one or more outside braids.

The corrugated steel hoses are product from very slim steel sheets welded by head-to-head or overlap processing.

APPLICAZIONI

I tubi flessibili ondulati trovano notevole utilizzo nel convogliamento di tutti i fluidi compatibili con gli acciai inossidabili (AISI321 - AISI316L). Sono consigliabili nelle applicazioni industriali specialmente nei settori: vapore, acqua surriscaldata, gas liquidi, solventi acidi, gas combustibili, aria, ossigeno, azoto, olio ecc.

Temperatura di esercizio:
AISI 321: - 250 / +800 °C
AISI 316: - 250 / +800 °C
Acciaio al Carbonio: fino a +350 °C

APPLICATIONS

he corrugated flexible steel hoses can be used to send all fluids compatibles with all kind of stainless steels (AISI321 - AISI316L). They are perfect for industrial using to send: vapor, hot water, liquified gasses, acid solvents, fuel, air, oxygen, nitrogen, oil etc.

Working temperature:
Stainless steel AISI 321: - 250 / +800 °C
Stainless steel AISI 316: - 250 / +800 °C
Carbon steel: up to +350 °C AISI 316: - 250 / +800 °C

TUBI FLESSIBILI INOX

TUBI ASSEMBLATI

I tubi si possono fornire assemblati con qualsiasi tipo di raccordo (UNI, ANSI, ecc.) e materiale (acciaio Inox, acciaio al carbonio, ecc.), saldati mediante saldobrasatura in lega d'argento o mediante metodo elettro-saldato (Tig).

WELDED FLEXIBLE

The flexible can be welded with all kind of fitting (UNI, ANSI, ecc.) and material (Stainless steel, carbon steel, ecc.), welded by silver brasewelding or electric welding (Tig).



TIPI DI RACCORDI

Maschio fisso: BSP - BSPT - NPT

**Femmina girevole
o fissa sede ogiva o sede piana**

Codolo liscio saldabile

Manicotto a saldare

**Bocchettone 3 pezzi femmina
o maschio**

Flangia fissa UNI - ANSI - DIN

Flangia girevole UNI - ANSI - DIN

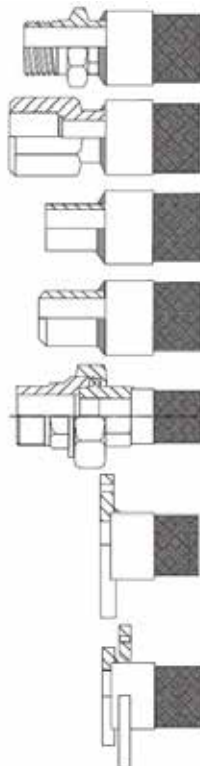

TIPI DI RACCORDI

Fixed male: BSP - BSPT - NPT

**Swivel or fixed female cone 60
or flat face**

Smooth pipe end

Welding stub

Nut union 3 pieces female or male

UNI - ANSI - DIN fixed flange

UNI - ANSI - DIN swivel flange

TUBI METALLICI METAL HOSES



DOPPIA GRAFFATURA



IMPIEGO

Tubo flessibile in **ACCIAIO ZINCATO** a doppia aggraffatura idoneo per realizzazione tubi di scarico gas (**marmite**), impianti aspirazione aria calda o fredda, protezione meccanica di cavi elettrici o tubi flessibili.

- Temperatura: +250°C

APPLICATION

Flexible double hose made of **GALVANIZED STEEL** for **gas exhaust pipes**, mechanical protection of electrical wiring, installation of hot and cold air intake application.

- Temperature range: +250°C

STRUTTURA

- **Acciaio al carbonio zincato a caldo EN10346 DX-51D+Z200**
- Struttura: Doppia aggraffatura, sezione tonda, profilo labirintico.

CONSTRUCTION

- **Galvanized steel EN10346 DX51D+Z200.**
- Structure: Winding and seamfolding of a profile strip.

Codice Part Number	Diametro Interno Inside Diameter	Ø Esterno O.D.	Raggio Curv. Bend Radius	Peso Weight	Lunghezza Length
101 000 020	20	25	70	0,51	5 - 10
101 000 025	25	30	86	0,62	5 - 10
101 000 030	30	35	102	0,73	5 - 10
101 000 035	35	40	117	0,84	5 - 10
101 000 040	40	45	163	1,10	5 - 10
101 000 045	45	50	182	1,23	5 - 10
101 000 050	50	55	201	1,36	5 - 10
101 000 055	55	60	221	1,49	5 - 10
101 000 060	60	65	240	1,62	5 - 10
101 000 065	65	70	259	1,75	5 - 10
101 000 070	70	75	278	1,88	5 - 10
101 000 075	75	80	297	2,01	5 - 10
101 000 080	80	85	316	2,14	5 - 10
101 000 085	85	90	336	2,27	5 - 10
101 000 090	90	95	355	2,40	5 - 10
101 000 095	95	100	374	2,53	5 - 10
101 000 100	100	105	393	2,66	5 - 10

Altre misure a richiesta - Other measures on request

● Fornibile in 7 gg lavorativi / Available in 7 working days



IMPIEGO

Tubo flessibile INOX corrugato, trecciato INOX A304. Idoneo per convogliamento dei fluidi (**olio diatermico, acque di raffreddamento ecc**) e acidi in ambienti con temperature critiche.

- Temperatura: -270°C +600°C

STRUTTURA

- Anima interna: acciaio INOX A304 – 321 - 316.
- Copertura: treccia acciaio INOX A304.

N.B. I TUBI POSSONO ESSERE FORNITI ASSEMBLATI, SALDATI ALL'ESTREMITÀ CON DIFFERENTI TIPI DI RACCORDI O FLANGE.

APPLICATION

Flexible stainless corrugated steel hose, stainless steel A304 braided. Suitable for fluid crossing (**diathermic oil, water for refrigerant circuits, etc.**) and acid fluids in ambients with critical temperatures.

- Temperature range: -270°C +600°C

CONSTRUCTION

- Inner tube: Stainless Steel A304 - 321 - 316.
- Cover: Stainless Steel A304 braid.

***THE HOSES CAN BE WELDED TO A LOT OF FITTINGS.**



Codice Part Number	Diametro Interno Inside Diameter			Ø Esterno O.D.	Pr. Esercizio Max WP	Pr. Esercizio Max WP	Pr. Scoppio Burst Pr.	Raggio Curv. Bend Radius	Lunghezza Lenght
	DN	Inch.	mm						
• 100 970 140	6	1/4"	6	10.7	150	230	616	25	10
• 100 970 516	8	5/16"	8	13.6	145	195	580	32	10
• 100 970 380	10	3/8"	10	15.6	105	157	420	40	10
• 100 970 120	12	1/2"	12	18.2	88	132	352	50	10
• 100 970 580	16	5/8"	16	23.1	73	109	292	50	10
• 100 970 340	20	3/4"	20	28.3	64	96	256	70	10
• 100 970 100	25	1"	25	33.7	50	75	200	90	10
• 100 970 114	32	1.1/4"	32	43.1	42	63	168	110	10
• 100 970 112	40	1.1/2"	40	52.1	32	48	128	130	10
• 100 970 200	50	2"	50	62.4	31	46	124	175	10
• 100 970 212	65	2.1/2"	65	77.4	26	39	104	200	5
• 100 970 300	80	3"	80	92.6	18	27	72	205	5
• 100 970 400	100	4"	100	112.8	16	24	64	230	5
• 100 970 500	125	5"	125	138	16	24	64	280	5
• 100 970 600	150	6"	150	163	12	18	48	320	5
• 100 970 800	200	8"	200	214	10	16	40	435	5



ACCESSORI PER TUBI
HOSES ACCESSORIES:

PROTEZIONI & ACCESSORI PER TUBI
HOSES PROTECTIONS & ACCESSORIES

SPIRALE TONDA METALLICA

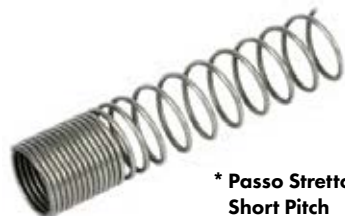

* Passo Stretto
Short Pitch

IMPIEGO

Spirale di protezione in acciaio zincato a **sezione tonda** utilizzata nelle applicazioni gravose che richiedono una protezione dei tubi oleodinamici contro tagli e abrasioni ed allo stesso tempo offrono una discreta resistenza alla curvatura eccessiva.

STRUTTURA

- Struttura: molla tonda in acciaio zincato.
- Resistenza all'abrasione: ottima.

APPLICATION

Galvanized steel protection spring with **round section** for those applications which call for tough, steel armor protection of the hydraulic hoses against cuts and abrasion and at the same time they offer a good resistance to excessive bending.

CONSTRUCTION

- Cover: galvanized rounded steel spring.
- Abrasion resistance: excellent.



Codice Part Number	Idonea per Tubi Suitable for Hoses			Diametro Interno Inside Diameter mm.	Lunghezza Length mt.
	1SN Inch.	2SN Inch.	Spiral Hose mm		
130 100 010	1/8"			10	10
130 100 015	1/4"	3/16"		15	10
130 100 017	5/16"	1/4"		17	10
130 100 019	3/8"	5/16"	1/4"	19	10
130 100 021		3/8"		21	10
130 100 023	1/2"	1/2"	3/8"	23	10
130 100 025	5/8"		1/2"	25	10
130 100 031	3/4"	5/8" - 3/4"	5/8"	31	5
130 100 033			3/4"	33	5
130 100 036				36	5
130 100 041	1"	1"	1"	41	5
130 100 048	1.1/4"		1.1/4"	48	5
130 100 051		1.1/4"		51	5
130 100 056	1.1/2"	1.1/2"	1.1/2"	56	5



• Fornibile in 7 gg lavorativi / Available in 7 working days

SPIRALE PIATTA IN POLIETILENE



IMPIEGO

Spirale di protezione in polietilene **Nero** ad alta densità che garantisce robustezza, elevata resistenza ai carichi di rottura e mantiene la flessibilità ed il raggio di curvatura del tubo su cui è montata.

- Temperatura: -75°C +120°C

STRUTTURA

- Struttura: spirale piatta **nera** in polietilene con bordi arrotondati.
- Resistenza ai raggi U.V.: buona.
- Confezione: comode scatole di cartone.

APPLICATION

Black protection high-density polyethylene spiral, which provides strength, high resistance to breaking loads and maintains the flexibility and the bend radius of the hose on which it is assembled.

- Temperature range: -75°C +120°C

CONSTRUCTION

- Cover: black flat polyethylene spring with rounded edges.
- Resistance to U.V. rays: good.
- Packaging: comfortable carton boxes.



Codice Part Number	Idonea per Tubi Suitable for Hoses			Diametro Interno Inside Diameter mm.	Lunghezza Length mt.
	1SN Inch.	2SN Inch.	Spiral Hose mm		
120 000 812	3/16"			8	50
120 001 216	1/4" - 5/16"	3/16" - 1/4"		13	20
120 001 620	3/8" - 1/2"	5/16" - 3/8"	3/8"	16	20
120 002 025	5/8"	1/2" - 5/8"	1/2"	20	20
120 002 732	3/4"	3/4"	5/8"	27	20
120 003 540	1"	1"	3/4"-1"	34	20
120 004 450	1.1/4"	1.1/4"	1.1/4"	43	20
120 005 663	1.1/2" - 2"	1.1/2"	1.1/2"	56	20
120 006 775	2.1/2" - 3"	2"	2"	67	20
120 008 090		2.1/2" - 3"		80	20
120 001 110				100	12



• Fornibile in 7 gg lavorativi / Available in 7 working days

▲ Taglio a misura applicato sovrapprezzo di 15,00 euro / Cut To Size Applied Supplement of 15 Euro

SPIRALE IN POLIETILENE GIALLA



IMPIEGO

Spirale di protezione in polietilene Gialla ad alta densità che garantisce robustezza, elevata resistenza ai carichi di rottura e mantiene la flessibilità ed il raggio di curvatura del tubo su cui è montata.

- Temperatura: -75°C +120°C

STRUTTURA

- Struttura: spirale piatta **gialla** in polietilene con bordi arrotondati.
- Resistenza ai raggi U.V.: buona.
- Confezione: comode scatole di cartone

APPLICATION

Yellow protection high-density polyethylene spiral, which provides strength, high resistance to breaking loads and maintains the flexibility and the bend radius of the hose on which it is assembled.

- Temperature range: -75°C +120°C

CONSTRUCTION

- Cover: **yellow** flat polyethylene spring with rounded edges.
- Resistance to U.V. rays: good.
- Packaging: comfortable carton boxes.



Codice Part Number	Idonea per Tubi Suitable for Hoses			Diametro Interno Inside Diameter mm.	Lunghezza Length mt.
	1SN Inch.	2SN Inch.	Spiral Hose mm		
120 101 216	1/4" - 5/16"	3/16" - 1/4"		12	20
120 101 620	3/8" - 1/2"	5/16" - 3/8"	3/8"	16	20
120 102 025	5/8"	1/2" - 5/8"	1/2"	20	20
120 102 732	3/4" - 1"	3/4" - 1"	5/8"	27	20
120 104 450	1.1/4" - 1.1/2"	1.1/4"	1.1/4" - 1.1/2"	44	20
120 106 775	2" - 2.1/2" - 3"	1.1/2" - 2"	2"	67	20
120 108 090		2.1/2" - 3"		80	20



• Fornibile in 7 gg lavorativi / Available in 7 working days

SPIRALE IN POLIETILENE FLUORESCENTE



IMPIEGO

Spirale di protezione in polietilene **Fluorescente** ad alta densità. **Sicurezza in cantiere per le persone ed i mezzi, le tubazioni idrauliche e le parti in movimento vengono riconosciute più facilmente, più sicurezza negli ambienti bui.**

STRUTTURA

- Struttura: spirale piatta **Fluorescente** in polietilene.
- Resistenza ai raggi U.V.: buona.
- Confezione: comode scatole di cartone.

APPLICATION

Protection high-density polyethylene **Fluorescent** spiral. **Safety on site for people and machinery, the hydraulic and the moving parts are recognized more easily, more safety in dark locations.**

CONSTRUCTION

- Cover: **Fluorescent** flat polyethylene spring.
- Resistance to U.V. rays: good.
- Packaging: comfortable carton boxes.



Codice Part Number	Idonea per Tubi Suitable for Hoses			Diametro Interno Inside Diameter mm.	Lunghezza Length mt.
	1SN Inch.	2SN Inch.	Spiral Hose mm		
121 000 812	3/16"			8	50
121 001 216	1/4" - 5/16"	3/16" - 1/4"		12	20
121 001 620	3/8" - 1/2"	5/16" - 3/8"	3/8"	16	20
121 002 025	5/8"	1/2" - 5/8"	1/2"	20	20
121 002 732	3/4"	3/4"	5/8"	27	20
121 003 540	1"	1"	3/4"-1"	35	20
121 004 450	1.1/4"	1.1/4"	1.1/4"	44	20
121 005 663	1.1/2" - 2"	1.1/2"	1.1/2"	56	20
121 006 775	2.1/2" - 3"	2"	2"	67	20
121 008 090		2.1/2" - 3"		80	20
120 001 110				100	12



• Fornibile in 7 gg lavorativi / Available in 7 working days

CALZA TESSILE



IMPIEGO

Calza tessile per il contenimento di tubi oleodinamici, pneumatici singoli o multipli.

- Temperatura: -40°C +100°C

STRUTTURA

- **Tubolare: 100 % Polipropilene.**
- Spessore: **1.40 mm** (+/- 1 %)
- Resistenza all'abrasione: >25.000 Cicli.
- Carico di rottura: da 428 a 1430 N.
- Allungamento rottura: da 29 a 33%

APPLICATION

Textile sleeve suitable for hydraulic and pneumatic sector. It can contain single or multiple hoses.

- Temperature range: -40°C +100°C

CONSTRUCTION

- **Hose: 100% Polypropylene.**
- Thickness: **1.40 mm** (+/- 1%)
- Abrasion resistance: >25.000 C.
- Stain at break: up 428 to 1430 N.
- Tensile Strength: up 29 to 33%



Codice Part Number	Idonea per Tubi Suitable for Hoses			Diametro Interno Inside Diameter mm.	Largh. appiattita Bend Radius mm.	Lunghezza Lenght mf.
	1SN Inch.	2SN Inch.	Spiral Hose mm			
150 000 015	3/16" - 1/4"	3/16"		15	27	50
150 000 017	1/4" - 5/16"	3/16"		18	30	50
150 000 020	3/8"	1/4" - 5/16"		20	35	20 - 100
150 000 022	1/2"	3/8"		22	40	20 - 100
150 000 025	5/8"	1/2"	3/8"	25	45	100
150 000 028		5/8"	1/2"	28	50	20 - 100
150 000 032	3/4"		5/8"	32	55	100
150 000 035		3/4"	3/4"	35	60	100
150 000 038	1"			38	65	20 - 100
150 000 045	1.1/4"	1"	1"	45	80	100
150 000 050			1.1/4"	50	90	20 - 100
150 000 070	1.1/2" - 2"	1.1/4" - 1.1/2"	1.1/4"-1.1/2"	70	120	100
150 000 090	2.1/2"	2" - 2.1/2"	2"	90	150	20 - 100
150 000 112	3"	3"		112	179	50



• Fornibile in 7 gg lavorativi / Available in 7 working days Taglio a misura applicato sovrapprezzo di 15,00 euro / Cut To Size Applied Supplement of 15 Euro

CALZA TESSILE / CHIUSURA CON VELCRO



IMPIEGO

Calza tessile per il contenimento di tubi oleodinamici, pneumatici singoli o multipli.

- **Dotata di comoda chiusura a strappo con velcro per facilitare le operazioni di calzamento su tubi multipli.**
- Temperatura: -40°C +125°C

STRUTTURA

- Resistenza all'**abrasione** secondo normativa **ISO 6945**.
- Buona Resistenza alla **Fiamma**.
- **Conducibilità Elettrica** come da normativa **ISO 8031** (3e5 Ohm/mt).

APPLICATION

Textile sleeve suitable for hydraulic and pneumatic sector. It can contain single or multiple hoses.

- **Provided with comfortable closing to tear with velcro to facilitate the protection operations on multiple hoses**
- Temperature range: -40°C +125°C

CONSTRUCTION

- **Abrasion** resistance according to **ISO 6945** norm.
- Good **Fire** Resistance.
- **Electrical Resistance** as per norms **ISO 8031** (3and5 Ohm/mt).



Codice Part Number	Diametro Interno Inside Diameter mm.	Lunghezza Lenght mf.
151 000 050	50	50
151 000 075	75	50
151 000 100	100	50
151 000 125	125	50
151 000 150	150	50
151 000 175	175	50
151 000 200	200	50



• Fornibile in 7 gg lavorativi / Available in 7 working days

CALZA IN FIBRA DI VETRO/SILICONE ROSSO



IMPIEGO

Calza in fibra di vetro con silicone utilizzata come **isolante termico ed elettrico** per tubi in ambienti con temperature superiori ai 538°C.

- Temperatura sopra i **1090°C** – 15-20 minuti;
- Temperatura sopra i **1650°C** – 15-30 secondi;

STRUTTURA

- Resistenza alla Fiamma: **autoestinguente**
- Normativa: si adegua alle norme **UL 144 I VW-I.**

APPLICATION

Glass fiber silicon braid used as **thermic and electric insulator** in demanding environments where temperatures reach up to 538°C. (1000 °F).

- Temperature up to **1090°C** - 15-20 minutes
- Temperature up to **1650°C** - 15 - 30 seconds

CONSTRUCTION

- Fire Resistance: **self-extinguishes.**
- According to: it adapts to teh norm **UL 144 I VW-I.**



Codice Part Number	Idonea per Tubi Suitable for Hoses		Spiral Hose mm	Diametro Interno Inside Diameter	Lunghezza Length
	1SN Inch.	2SN Inch.		mm.	mt.
110 100 010				10	20
110 100 012				12	20
110 100 016	3/16" - 1/4"	3/16"		16	20
110 100 019	5/16"	1/4" - 5/16"		19	20
110 100 022	3/8"	3/8"		22	20
110 100 025	1/2"	1/2"	3/8"	25	20
110 100 028	5/8"	5/8"	1/2"	28	10 - 20
110 100 032	3/4"	3/4"	5/8"	32	20
110 100 035			3/4"	35	20
110 100 038	1"			38	20
110 100 041		1"		41	10 - 20
110 100 044			1"	44	5 - 15
110 100 051	1.1/4"	1.1/4"		51	15
110 100 057	1.1/2"		1.1/4"	57	15
110 100 063		1.1/2"	1.1/2"	63	5 - 15
110 100 070	2"	2"		70	15
110 100 076			2"	76	5 - 15
110 100 082				82	15
110 100 088	2.1/2"	2.1/2"		88	15
110 100 095				95	15
110 100 102	3"	3"		102	5 - 15
110 100 114				114	15
110 100 120				120	15

• Fornibile in 7 gg lavorativi / Available in 7 working days

NASTRO IN SILICONE ROSSO



IMPIEGO

Nastro in silicone resistente alle alte temperature, fornisce uno strato isolante contro i liquidi quindi ideale come **chiusura di estremità dei tubi ignifughi**. Per applicarlo sovrapporlo per circa il 50% della sua larghezza per ottenere un'adesione ottimale.

- Temperatura: +246°C

STRUTTURA

- Struttura: silicone rosso non adesivo autoreticolante.
- Allungamento: 300%
- Resistenza alla trazione: moderata.

APPLICATION

Silicone tape resistant to high temperatures, provides an insulating layer against liquids so ideal as **end closure of fire-proof hoses**. To apply overlapped to about 50% of its width to achieve optimal adhesion.

- Temperature: +246°C

CONSTRUCTION

- Cover: red silicone non-adhesive self-crosslinking.
- Elongation: 300%
- Tensile strenght: moderate.



Codice Part Number	Diametro Interno Inside Diameter	Largh. appiattita Bend Radius	Lunghezza Length
	mm.	mm.	mt.
110 125 011	+246°C	25	11
110 138 011	+246°C	38	11
110 125 018	+260°C	25	18



• Fornibile in 7 gg lavorativi / Available in 7 working days



IMPIEGO

Anello in alluminio ferma calza/guaina. Evita lesioni perché senza spigoli vivi, come ad esempio con fascette stringitubo o fascette fermacavi. L'ancoramento viene eseguito con la presa direttamente sulla boccola già pressata del tubo flessibile.

STRUTTURA

- Applicazione semplice e veloce.
- Adesione della calza/guaina ottimale con il minimo ingombro.

APPLICATION

Aluminium ring for sleeves fixing. Prevents damage because without sharp edges, such as with hose clamps or cable ties. The anchoring is executed with the crimping machine directly to the ferrule already crimped of the flexible hose.

CONSTRUCTION

- Simply and fast application
- Optimally fixing off he sleeves with minimum crowd.



Codice Part Number	Spessore Thickness mm.	Diametro Interno Inside Diameter mm.	Quantità Minima Minimum Quantity pz.
152 000 022	1,5	22	20
152 000 025	1,5	25	20
152 000 029	1,5	29	20
152 000 032	1,5	32	20
152 000 035	1,5	35	20
152 000 039	1,5	39	20
152 000 042	1,5	42	20
152 000 047	1,5	47	20
152 000 057	1,5	57	10
152 000 067	2,0	67	10



• Fornibile in 7 gg lavorativi / Available in 7 working days



IMPIEGO

Guaina in PVC per protezione tubi e cavi.
• Temperatura: -15°C +80°C

STRUTTURA

- Struttura: monoestruso in PVC nero antifiamma.
- Durezza: shore A 75 ± 5
- Allungamento a rottura: 310%
- Carico di rottura: 13.5 N/mm².
- Normativa: **CEI 20-22 CEI 20-14.**

APPLICATION

Hose and cable protection PVC sheat.
• Temperature range: -15°C +80°C

CONSTRUCTION

- Cover: one-layer flame free black PVC.
- Hardness: shore A 75 ± 5
- Breaking stretching: 310%
- Breaking load: 13.5 N/mm².
- According to: **CEI 20-22 CEI 20-14.**



Codice Part Number	Idonea per Tubi Suitable for Hoses			Diametro Interno Inside Diameter mm.	Ø Esterno O.D. mm.	Lunghezza Lenght mt.
	1SN Inch.	2SN Inch.	Spiral Hose mm			
• 110 000 010				10	11	150
• 110 000 016	3/16" - 1/4"			16	17	100
• 110 000 018	5/16"	3/16"		18	19,2	100
• 110 000 020	3/8"	1/4"		20	21,2	25 - 100
• 110 000 022		5/16" - 3/8"		22	23,2	25 - 100
• 110 000 024	1/2"			24	25,2	100
• 110 000 025		1/2"	3/8"	25	26,2	25 - 100
• 110 000 028	5/8"		1/2"	28	29,2	100
• 110 000 030		5/8"		30	31,2	25 - 50
• 110 000 033	3/4"	3/4"	5/8"	33	34,4	50
• 110 000 036			3/4"	36	37,4	50
• 110 000 038			3/4"	38	39,4	25 - 50
• 110 000 040	1"			40	41,4	25 - 50
• 110 000 045		1"	1"	45	46,4	50
• 110 000 050	1.1/4"			50	51,4	50
• 110 000 055	1.1/2"	1.1/4"	1.1/4"	55	56,4	50



• Fornibile in 7 gg lavorativi / Available in 7 working days



IMPIEGO

Tubo in gomma telato usato per il rivestimento e la protezione dei cavi.

- Temperatura: -35°C +70°C

STRUTTURA

- Sottostrato: liscio in gomma sintetica con tessuto visibile.
- Copertura: in gomma sintetica, resistente alle intemperie, all'abrasione ed all'ozono.
- Superficie: nera liscia ad impressione di tela.

APPLICATION

Rubber hose used for covering and protection of cables.

- Temperature range: -35°C +70°C

CONSTRUCTION

- Tube: black, smooth synthetic rubber with visible fabric.
- Cover: synthetic rubber weather, abrasion and ozone resistant outer layer.
- Surface: black smooth, fabric finished.



Codice Part Number	Diametro Interno Inside Diameter mm.	Ø Esterno O.D. mm.	Peso Weight Kg./mt.	Lunghezza Length mt.
110 102 527	25	27	0,10	20 - 40
110 102 831	28	31	0,10	20 - 40
110 103 235	32	35	0,12	20 - 40
110 103 841	38	41	0,15	20 - 40
110 104 043	40	43	0,16	20 - 40
110 105 053	50	53	0,24	20 - 40



• Fornibile in 7 gg lavorativi / Available in 7 working days

IL KIT PER IL SISTEMA DI CONTROLLO PRESSATURA HSR

“HSR-Sicur Fit” offre la possibilità di un controllo di sicurezza dei diametri di pressatura finali per i tubi flessibili utilizzati con i raccordi Zinco-Nichel della propria gamma Standard ed Interlock.



Gamma “Standard”:
Codice 090 000 008

n° 8 tamponi che da una parte misurano il collassamento dei raccordi per i tubi flessibili treciati dal Ø 3/16” al Ø 1.1/4” e dall'altra parte misurano il collassamento dei raccordi per i tubi spiralati da 1/4” a 1.1/4”; (a richiesta si possono avere i tamponi per i raccordi da 1.1/2” e 2”).



Gamma “Interlock”:
Codice 090 001 003

n° 3 tamponi che misurano il collassamento dei raccordi per i tubi flessibili piralati dal 3/4” al 2”;



“HSR-Sicur Fit” fornito in una comoda custodia che ne facilita lo stoccaggio ed il trasporto.

TAPPO SERVICE

TAPPO UNIVERSALE IN GOMMA IN TRE MISURE
PER L'OCCLUSIONE RAPIDA DELLE
CONNESSIONI OLEODINAMICHE





CAMPI DI IMPIEGO:

- Oleodinamica: tubi flessibili, pompe, motori ecc..
- Automotive: impianto frenante, carburante, olio, aria condizionata.
- Industria: taglio, olio di raffreddamento.
- Trattamento delle superfici: pittura, decappaggio.

VANTAGGI:

- Semplicità di montaggio e smontaggio.
- Evita le perdite di olio o sostanze chimiche durante le operazioni di manutenzione scongiurando inutili inquinamenti.

- Evita la necessità di rabbocco dell'olio fuoriuscito ottenendo un risparmio sui costi d'intervento.
- Evita la possibilità di entrata nel circuito oleodinamico di impurità dannose all'impianto.
- È riutilizzabile (pulire bene prima dell'uso) e si adatta a tutti i tipi di raccordi e diametri (da 1 a 42 mm) grazie alla sua forma lunga e a cono.
- Utilizzare in assenza di pressione.
- Resistenze: realizzato in gomma di alta qualità resistente agli olii ed ai prodotti chimici (gomma al silicone).
- Temperatura d'esercizio: da -25°C a +95°C

Codice Part Number	Descrizione Description		
345 100 110	Confezione da 20 pz	MICRO	
355 100 110	Pezzo singolo		
345 100 423	Confezione da 10 pz	MEDIO	
355 100 423	Pezzo singolo		
345 101 243	Confezione da 5 pz	XL	
355 101 243	Pezzo singolo		
345 100 100	Box di assortimento di tutti e tre le misure dei tappi service	4 MICRO 4 MEDIO 2 XL	



TAPPO UNIVERSALE IN GOMMA



IMPIEGO

Capsula protettiva in gomma con una vasta gamma di applicazioni per la protezione contro lo sporco e danni, ad esempio, per i cavi e le estremità del tubo.

STRUTTURA

Poco costoso, universale. Protezione contro la contaminazione. Protezione contro i danni.

APPLICATION

Protective rubber caps with a wide range of applications for protection against dirt and damage, for example, for the wires and the ends of the hose.

CONSTRUCTION

Inexpensive, universal. Protection against contamination. Protection against damage.

Codice Part Number	Diametro Interno Inside Diameter	Lunghezza Length	Range d'impiego Application range		Quantità Minima Minimum Quantity
			da / from mm	a / to mm	
345 200 009	8,71	12,70	8,50	10,49	75
345 200 011	11,10	12,70	10,50	12,49	250
345 200 013	13,49	12,70	13,50	14,49	150
345 200 016	15,88	19,05	14,50	16,49	125
345 200 017	17,45	19,05	16,50	18,49	250
345 200 019	19,05	19,05	18,50	20,49	250
345 200 021	21,41	25,40	20,50	22,49	300
345 200 024	23,80	19,05	22,50	24,49	100
345 200 025	25,40	25,40	24,50	27,49	125
345 200 027	26,99	25,40	25,50	28,59	75
345 200 029	28,58	25,40	27,50	30,49	90
345 200 032	31,75	25,40	30,50	32,49	50
345 200 035	34,93	25,40	32,50	36,49	100
345 200 038	38,10	25,40	36,50	38,49	75
345 200 041	41,28	25,40	39,50	41,49	75
345 200 048	47,63	25,40	45,50	47,49	50
345 200 051	50,80	25,40	47,50	50,49	25
345 200 057	57,15	25,40	54,50	57,49	50
345 200 060	60,33	25,40	57,50	60,49	50

● Fornibile in 7 gg lavorativi / Available in 7 working days

TAPPI PLASTICA PER RACCORDI



IMPIEGO

Tappi in PVC utilizzati per impedire inclusioni di impurità esterne o fuoriuscite di liquido nei tubi raccordati e per proteggere da colpi i filetti dei raccordi oleodinamici.

APPLICATION

PVC caps used to stop inclusions of external contamination or leaks in the hose assemblies and to protect from shocks to the threads of hydraulic fittings.



Codice Part Number	Codice Part Number	Per Filetto For Thread Inch.	Pz Pcs
345 300 002	345 400 002	G 1/8"	50
345 300 004	345 400 004	G 1/4"	50
345 300 006	345 400 006	G 3/8"	50
345 300 008	345 400 008	G 1/2"	50
345 300 010	345 400 010	G 5/8"	10
345 300 012	345 400 012	G 3/4"	10
345 300 016	345 400 016	G 1"	10
	345 400 020	G 1.1/4"	10
	345 400 024	G 1.1/2"	10
	345 400 032	G 2"	10

Codice Part Number	Codice Part Number	Per Filetto For Thread Inch.	Pz Pcs
345 500 122	345 600 122	M12x1,5	50
345 500 142	345 600 142	M14x1,5	50
345 500 162	345 600 162	M16x1,5	50
345 500 182	345 600 182	M18x1,5	50
345 500 202	345 600 202	M20x1,5	50
345 500 222	345 600 222	M22x1,5	50
345 500 242	345 600 242	M24x1,5	10
345 500 262	345 600 262	M26x1,5	10
345 500 303	345 600 303	M30x2	10
345 500 363	345 600 363	M36x2	10
345 500 423	345 600 423	M42x2	10
345 500 453	345 600 453	M45x2	10
345 500 523	345 600 523	M52x2	10



Codice Part Number	Codice Part Number	Per Filetto For Thread Inch.	Pz Pcs
345 700 004		7/16"-20	50
345 700 005		1/2"-20	50
345 700 006	345 800 006	9/16"-18	50
345 700 008		3/4"-16"	50
345 700 010		7/8"-14	10
345 700 012	345 800 012	1.1/16"-12	10
345 700 020	345 800 020	1.5/8"-12	10
345 700 024		1.7/8"-12	10

Codice Part Number	Codice Part Number	Per Filetto For Thread Inch.	Pz Pcs
345 903 008	345 906 008	1/2"	10
345 903 012	345 906 012	3/4"	10
345 903 016	345 906 016	1"	10
345 903 020	345 906 020	1.1/4"	10
345 903 024	345 906 024	1.1/2"	10
345 903 032	345 906 032	2"	10

● Fornibile in 7 gg lavorativi / Available in 7 working days

JETCLEAN SYSTEM



L'EFFICIENTE SISTEMA DI PULIZIA A SECCO PER TUBI RIGIDI E FLESSIBILI
EFFICIENT SYSTEM OF DRY CLEANING FOR TUBES AND HOSES



IMPIEGO

Prima Fase:

a seconda del diametro del tubo viene inserito l'ugello corrispondente nella pistola apposita;

Seconda Fase:

viene inserito nella pistola l'apposito proiettile;

Terza Fase:

l'ugello della pistola viene inserito nel tubo da pulire.



APPLICATION

First stage:

depending on the diameter of the tube is inserted into the corresponding nozzle in the gun proper;

Second stage:

is inserted into the appropriate gun bullet;

Third stage:

the nozzle of the gun is inserted in the tube to be cleaned.

VANTAGGI

- Rapido, economico, adattabile ed efficace.
- Pochissimi secondi per la pulizia dei tubi rigidi e flessibili.
- Riduzione fermi macchina attraverso una manutenzione costante.
- Costo d'applicazione e manutenzione dei macchinari notevolmente ridotto.
- Possono essere puliti tubi rigidi e flessibili con lunghezze fino a 100 mt con diametri fino a 2".
- Possibilità di adattare il sistema anche sui furgoni "officine mobili SPRINTER".
- Con la pulizia a secco non è più necessario utilizzare sostanze chimiche come solventi o diluenti (non ci sono più costi di smaltimento di prodotti chimici, non ci sono rischi per gli operatori)

ADVANTAGE

- Fast, Cheap, adaptable and effective.
- Very few seconds for cleaning the pipes and hoses.
- Reduce downtime through constant maintenance.
- Cost of application and maintenance machinery greatly reduced.
- They can be cleaned pipes and flexible with lengths up to 100 meters with diameters up to 2".
- Possibility to adapt the system also vans "mobile workshops SPRINTER".
- With the dry cleaning is no longer need to use chemicals as solvents or diluents (there are no more disposal costs of products chemicals, there are risks to operators).



Pistola Standard
Standard Gun

Codice Part Number	Descrizione Description
090 100 000	Pistola Standard



Pistola Eco
Eco Gun

Codice Part Number	Descrizione Description
090 100 001	Pistola Eco



Kit con Valigetta
Carrying Case Kit

Codice Part Number	Descrizione Description
090 300 000	Kit pulizia Tubo Flessibile (10 ugelli da 1/4" a 2")
090 400 000	Kit pulizia Tubo Rigido (10 ugelli a scelta)
090 500 000	Valigetta con alloggiamenti pistola e ugelli



**Pistola comando
a Pedale**
Foot Switch Gun

Codice Part Number	Descrizione Description
090 200 000	Pistola comando a pedale



Ugelli Tubo Flessibile
Hydraulic Hose Nozzle

Codice Part Number	Misura Tubo Hose Size		Impiego Applications
	DN	Inch.	
090 300 004	6	1/4"	Tubo Flessibile
090 300 005	8	5/16"	Tubo Flessibile
090 300 006	10	3/8"	Tubo Flessibile
090 300 008	13	1/2"	Tubo Flessibile
090 300 010	16	5/8"	Tubo Flessibile
090 300 012	19	3/4"	Tubo Flessibile
090 300 016	25	1"	Tubo Flessibile
090 300 020	32	1.1/4"	Tubo Flessibile
090 300 024	40	1.1/2"	Tubo Flessibile
090 300 032	50	2"	Tubo Flessibile



Proiettili Tubo Flessibile
Hydraulic Hose Projectiles

Codice Part Number	Misura Tubo Hose Size		Impiego Applications	Pz Pcs
	DN	Inch.		
090 310 003	5	3/16"	Tubo Flessibile	300
090 310 004	6	1/4"	Tubo Flessibile	300
090 310 005	8	5/16"	Tubo Flessibile	300
090 310 006	10	3/8"	Tubo Flessibile	300
090 310 008	13	1/2"	Tubo Flessibile	300
090 310 010	16	5/8"	Tubo Flessibile	100
090 310 012	19	3/4"	Tubo Flessibile	100
090 310 016	25	1"	Tubo Flessibile	100
090 310 020	32	1.1/4"	Tubo Flessibile	50
090 310 024	40	1.1/2"	Tubo Flessibile	50
090 310 032	50	2"	Tubo Flessibile	50

● Fornibile in 7 gg lavorativi / Available in 7 working days



Ugelli Tubo Rigido
Rigid Tube Nozzle

Codice Part Number	Ø Est.	Ø Int.	Impiego Applications
	O. D.	I. D.	
mm			
090 400 603	6	3	Tubo Rigido
090 400 604	6	4	Tubo Rigido
090 400 805	8	5/6	Tubo Rigido
090 401 005	10	5/6	Tubo Rigido
090 401 007	10	7/8	Tubo Rigido
090 401 208	12	8/11	Tubo Rigido
090 401 409	14	9/11	Tubo Rigido
090 401 511	15	11/14	Tubo Rigido
090 401 610	16	10/14	Tubo Rigido
090 401 814	18	14/17	Tubo Rigido
090 401 913	19	13/15	Tubo Rigido
090 402 014	20	14/17	Tubo Rigido
090 402 018	20	18	Tubo Rigido
090 402 216	22	16/20	Tubo Rigido
090 402 515	25	15/18	Tubo Rigido
090 402 519	25	19/21	Tubo Rigido
090 402 523	25	23	Tubo Rigido
090 402 522	25,4	22/23	Tubo Rigido
090 402 818	28	18/21	Tubo Rigido
090 402 822	28	22/25	Tubo Rigido
090 402 828	28	26	Tubo Rigido
090 403 020	30	20/23	Tubo Rigido
090 403 024	30	24/28	Tubo Rigido
090 403 529	30	29/34	Tubo Rigido
090 403 828	38	28/31	Tubo Rigido
090 403 832	38	32/24	Tubo Rigido
090 404 236	42	36/39	Tubo Rigido



Proiettili Tubo Rigido
Rigid Tube Projectiles

Codice Part Number	Ø Int.	Impiego Applications	Pz Pcs
	I. D.		
mm			
090 410 003	3	Tubo Rigido	300
090 410 004	4	Tubo Rigido	300
090 310 003	5	Tubo Rigido	300
090 310 004	6	Tubo Rigido	300
090 410 007	7	Tubo Rigido	300
090 310 005	8	Tubo Rigido	300
090 410 009	9	Tubo Rigido	300
090 310 006	10/11	Tubo Rigido	300
090 310 008	12	Tubo Rigido	300
090 411 314	13/14	Tubo Rigido	300
090 410 015	15	Tubo Rigido	300
090 310 010	16/17	Tubo Rigido	100
090 410 018	18	Tubo Rigido	100
090 310 012	19/21	Tubo Rigido	100
090 412 223	22/23	Tubo Rigido	100
090 310 016	24/25	Tubo Rigido	100
090 412 628	26/28	Tubo Rigido	50
090 412 931	29/31	Tubo Rigido	50
090 310 020	32/34	Tubo Rigido	50
090 413 536	35/36	Tubo Rigido	50
090 413 739	37/39	Tubo Rigido	50
090 310 024	40/42	Tubo Rigido	50
090 414 345	43/45	Tubo Rigido	50
090 414 648	46/48	Tubo Rigido	50
090 414 950	49/50	Tubo Rigido	50

L'EFFICIENTE SISTEMA DI PULIZIA A SECCO PER TUBI RIGIDI E FLESSIBILI

EFFICIENT SYSTEM OF DRY CLEANING FOR TUBES AND HOSES



VANTAGGI

- Sicurezza adottata ai tubi flessibili per evitare che la forza sprigionata dallo sfilamento dei raccordi possa innescare un temibile "Effetto Frusta" molto pericoloso per cose o persone nelle vicinanze.
- Ancoraggio tramite fune all'impianto.
- I componenti possono essere applicati a tutti i tipi di tubo flessibile, nippli, flange SAE ed ad altri tipi di terminali.
- Collaudato per garantire il trattenimento del tubo fino alla pressione massima indicata nel presente catalogo facendo riferimento alle normative EN853, EN854, EN855, EN856, EN857 e SAE J517.

ADVANTAGE

- Security adopted to flexible hoses to avoid the energy unleashed by the disconnection from the fitting may trigger a fighting "Whip Effect" extremely dangerous to anyone or anything in its vicinity.
- Securing to the plant by means of a cable.
- The components can be applied to all kinds of flexible hoses, nipples, to SAE flange and other terminal type.
- Tested to ensure the retention of the hose up the maximum pressure indicated in this catalogue in compliance with the standards EN853, EN854, EN855, EN856, EN857 and SAE J517.



IMPIEGO

Prima Fase: Sfilamento

Il Security System non entra in funzione durante la fase di sfilamento del tubo flessibile ma, se applicato correttamente, fa in modo che il tubo si sganci completamente dalla bussola che lo trattiene. Durante questa fase il tubo flessibile acquista velocità e potenza a causa dell'aumento della pressione dell'olio in esso contenuto;

Seconda Fase: Rilascio/Sfogo della Pressione

In questa fase l'olio in pressione fuoriesce dal tubo flessibile che inizia a sprigionare tutta la forza che tratteneva al suo interno acquistando notevole velocità e innescando un temibile "effetto frusta", molto pericoloso per cose o persone nelle sue vicinanze;

Terza Fase: Trattenimento

Sfilato il tubo e sfogata la pressione, il tubo flessibile deve quindi essere trattenuto, ed è in questa fase che entra in funzione il Security System: la fune d'acciaio si tende e si deforma mentre la piastrina incide la gomma del tubo impedendo il distacco della fascetta, saldamente ancorata al tubo. Fascetta e piastrina cominciano a loro volta a deformarsi elasticamente assorbendo la forza scatenata dalla corsa del tubo flessibile. Si tratta di una fase molto critica che si verifica in poche frazioni di secondo durante le quali i materiali e le forme del sistema, precedentemente dimensionati e testati, arrestano la pericolosa corsa del tubo flessibile.

APPLICATION

First stage: Disengagement

The Security system does not operate during the step of disengaging the flexible hose, but, if applied correctly, it ensures that the hose is fully disengaged from the ferrule that restrains it. During this step, the flexible hose gains velocity and power due to the pressure increase of the oil contained therein;

Second stage: Release/Venting of Pressure

During this step, the pressurised oil exits from the flexible hose. The hose begins to release the energy contained therein, and gains considerable velocity, triggering a hazardous "whip effect" which is very dangerous to anyone or anything in its vicinity;

Third stage: Restraint

Once the hose has been disengaged and the pressure released, the flexible hose can be restrained. This is where the Security system gets into operation: the stainless steel cable is tensioned and deformed while the plate cuts into the rubber of the hose, preventing the clamp, firmly attached to the hose, from disengaging. The hose clamp and plate start to deform in turn, elastically absorbing the force released from the travel of the flexible hose.

This is a critical step which occurs within just a few seconds in which the materials and the components of the system, previously sized and tested, stop the dangerous travel of the flexible hose.

1



2



3



FASCETTE PER TUBO FLESSIBILE

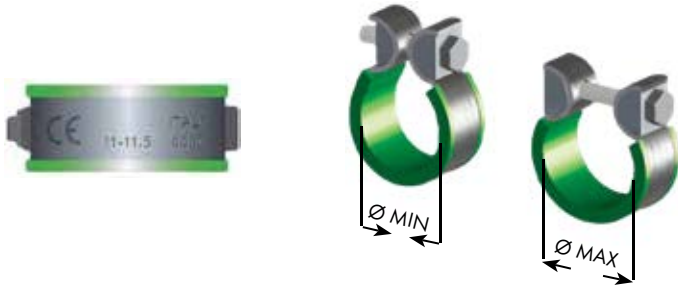

Ugelli Tubo Flessibile
Hydraulic Hose Nozzle

Codice Part Number	Range Impiego Use Range		Conf. Box pz
	Ø Min	Ø Max	
446 011 115	11	11,5	2/10
446 012 125	12	12,5	2/10
446 013 135	13	13,5	2/10
446 001 415	14	15	2/10
446 001 617	16	17	2/10
446 001 718	17	18	2/10
446 001 819	18	19	2/10
446 002 021	20	21	2/10
446 002 122	21	22	2/10
446 002 223	22	23	2/10
446 002 425	24	25	2/10
446 002 526	25	26	2/10
446 002 627	26	27	2/10
446 002 728	27	28	2/10
446 002 829	28	29	2/10
446 003 031	30	31	2/10
446 003 233	32	33	2/10
446 003 435	34	35	2/10
446 003 637	36	37	2/10
446 003 839	38	39	2/10
446 003 940	39	40	2/10

Codice Part Number	Range Impiego Use Range		Conf. Box pz
	Ø Min	Ø Max	
446 004 041	40	41	2/10
446 004 243	42	43	2/10
446 004 344	43	44	2/10
446 004 445	44	45	2/10
446 004 547	45	47	2/10
446 004 850	48	50	2/10
446 005 153	51	53	2/10
446 005 354	53	54	2/10
446 005 456	54	56	2/10
446 005 759	57	59	2/10
446 006 062	60	62	2/10
446 006 365	63	65	2/10
446 006 668	66	68	2/10
446 006 971	69	71	2/10
446 007 274	72	74	2/10
446 007 577	75	77	2/10
446 007 880	78	80	2/10
446 008 183	81	83	2/10
446 008 486	84	86	2/10
446 008 789	87	89	2/10
446 009 092	90	92	2/10
446 009 395	93	95	2/10

● Fornibile in 7 gg lavorativi / Available in 7 working days

ELEMENTI TENUTA NIPPLI

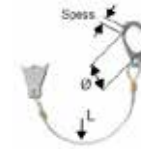

Elementi Tenuta Nippli
Nipple Retention System

Codice Part Number	Ø	Maschio BSP	Maschio Metr.	Spessore Thickness	L	* Pressione Max lavoro	Conf. Box
		BSP Male	Metric Male			* Max Working Pressure	
	mm	mm	mm	mm	mm	bar	pz
446 001 145	14,5	1/4"	M14	2	300	450	2/10
446 000 017	17	3/8"	M16	2	300	445	2/10
446 000 185	18,5		M18	2	300	420	2/10
446 001 205	20,5		M20	2	300	420	2/10
446 000 225	22,5	1/2"	M22	2	300	420	2/10
446 000 245	24,5	5/8"	M24	2	300	420	2/10
446 000 265	26,5	3/4"	M26	2	300	420	2/10
446 000 305	30,5		M30	2,5	300	420	2/10
446 000 034	34	1"		2,5	450	420	2/10
446 000 365	36,5		M36	2,5	450	420	2/10
446 000 425	42,5	1.1/4"	M42	2,5	450	420	2/10
446 000 455	45,5		M45	2,5	450	420	2/10
446 000 049	49	1.1/2"		2,5	450	420	2/10
446 000 525	52,5		M52	2,5	450	385	2/10
446 000 060	60	2"		2,5	450	350	2/10

* Intesa come pressione MAX di lavoro del sistema di trattamento.
Intended as the MAX operating pressure of the retention system

● Fornibile in 7 gg lavorativi / Available in 7 working days

SECURITY SYSTEM

ELEMENTI TENUTA FLANGE SAE 3000/6000

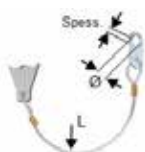

Elementi Tenuta Flange
Flange Retention System

Codice Part Number	Ø	Spessore Thickness	L	* Pressione Max lavoro * Max Working Pressure	Conf. Box
	mm	mm	mm	bar	pz
● 446 000 085	8,5	4	300	415	2/10
● 446 002 105	10,5	4	300	420	2/10
446 000 105	10,5	4	450	420	2/10
● 446 000 125	12,5	4	450	420	2/10
446 000 145	14,5	4	450	420	2/10
446 000 165	16,5	4	450	420	2/10
446 000 205	20,5	4	450	350	2/10
● 446 000 025	25	8	550	350	2/10
● 446 000 032	32	8	550	210	2/10

* Intesa come pressione MAX di lavoro del sistema di trattamento.
 Intended as the MAX operating pressure of the retention system



RACCORDI PER TUBO FLESSIBILE
FLEXIBLE HOSE FITTINGS

BOCCOLE & RACCORDI STANDARD
STANDARD FERRULES & FITTINGS



IMPIEGO

La nostra azienda è da sempre impegnata nella ricerca costante di tecnologie e processi che garantiscano ai nostri prodotti uno standard qualitativo elevato.

In quest'ottica già da qualche anno abbiamo introdotto nel nostro programma di vendita che concerne la **raccorderia per il tubo flessibile, la raccorderia DIN 2353 per il tubo rigido, gli innesti rapidi e la valvole a sfera per alta pressione, un trattamento anticorrosione con zincatura ecologica Zinco/Nichel unito ad un'ulteriore protezione sigillante, per garantire:**

- Super protezione alla corrosione
- Coppia di serraggio ottimale
- Rispondenza alle direttive europee: RoHS 2002/95/CE e ELV 2000/53/CE del 1° luglio 2007.

Prove in nebbia salina confermano una protezione oltre le 700 ore.

Questo per rispondere alle esigenze di mercato che richiedono elevate resistenze alla corrosione anche in ambienti idraulici particolarmente aggressivi.

Lo speciale trattamento superficiale a base di Zinco/Nichel associato al protettivo sigillante autolubrificante con uno spessore globale tra 6-10 micron ed una percentuale di Nichel tra il 12-15%, garantisce un **eccellente protezione anticorrosiva con una resistenza notevolmente superiore alla corrosione rispetto al sistema di zincatura standard in Cr3+** attualmente in commercio ed un **ottima protezione per le parti soggette a pinzatura o montaggio** (boccole, dadi ecc..).

Test di laboratorio in nebbia salina hanno rilevato l'assenza di ruggine rossa con questi valori:

- 1.000 ore per parti non stressate;
- 600 ore per parti stressate.

Il prodotto finito con la zincatura Zinco/Nichel si presenta con una superficie **GRIGIO OPACA**, e rappresenta una **valida alternativa all'utilizzo di raccorderia in acciaio INOX per impieghi gravosi** dove non si è obbligatoriamente soggetti all'impiego di tale materiale.

APPLICATION

Our company has always been committed to the constant search for technologies and processes that ensure a high quality standard for our products.

With this in mind a few years ago we introduced in our sales program concerning the **fittings for flexible hoses, pipe fittings DIN 2353 for the rigid tube, quick couplings and ball valves for high pressure, an anti-corrosion treatment with a new ecological zinc/nickel passivation combined with an additional film coated protection, to ensure:**

- super protection against corrosion
- optimal tightening torque
- correspondence with the European directives: RoHS 2002/95/CE and ELV 2000/53/CE from July 1, 2007.

We perform salt spray testing to confirm protection above 700 hrs.

This is to respond to market demands which require high resistance to corrosion even in particularly aggressive environments hydraulic.

Special surface treatment based on Zinc/Nickel associated with the self-lubricating film coated protection with an overall thickness of 6-10 microns and a percentage of between 12-15% Nickel, guarantees **excellent corrosion protection to a much higher resistance to corrosion than the standard galvanizing Cr3+ system** currently on the market and an **optimal protection for parts subjected to crimping or assembly** (ferrules, nuts etc ..).

Laboratory tests in salt spray have noted the absence of red rust with these values:

- 1,000 hours for non-stressed parts;
- 600 hours for stressed parts.

The finished product with galvanizing Zinc/Nickel presents a **GRAY MATT** surface, and represents a **viable alternative to the use stainless steel fittings for heavy duty use** where it is not subjected to the use of such materiale.

RISULTATI DELLE PROVE IN NEBBIA SALINA ESEGUITE IN LABORATORIO TEST RESULTS IN SALT SPRAY MADE IN THE LABORATORY



VANTAGGI

- Super resistenza alla corrosione (norma EN ISO 9227):
 - parti non stressate maggiore di 700 ore;
 - parti stressate maggiore di 350 ore.
- Conformità alle direttive europee RoHS 2007.
- Ruggine bianca evidenziata sotto forma di lieve alone grigio (non infiorescenza bianca come accade con il trattamento classico Cr3+).
- Soluzione ecologica con assenza totale di Cromo.
- Compatibilità con tutti i fluidi idraulici in commercio.
- Coppie di serraggio invariate.
- Standard già approvato nel settore Automotive.
- 100% prodotto **ITALIANO** certificabile a richiesta.

ADVANTAGE

- Super corrosion resistance (EN ISO 9227):
 - Parties not stressed exceed 700 hours;
 - Parties stressed exceed 350 hours.
- Conformity to European RoHS directives 2007.
- White rust highlighted in the form of slight halo gray (not white inflorescence as with the classic treatment Cr3+).
- Environmentally friendly with total absence of chrome.
- Compatible with all hydraulic fluids on the market.
- Tightening torques unchanged.
- Standard already approved in the automotive sector.
- 100% **ITALIAN** certifiable product on request.



**Codici in neretto
NO Zinco-Nichel**



Tubo / Hose		Tubo / Hose 1SC-R7-TP1-R8-E- LEVATOR	Tubo / Hose 1SN-2SN-2SC	Tubo / Hose 1SN	Tubo / Hose 2SN
DN	inch.	Codice / Part. nr.	Codice / Part. nr.	Codice / Part. nr.	Codice / Part. nr.
5	3/16"	*	014 120 316	●	014 601 316 ●
6	1/4"	014 701 140	*	014 120 140	014 601 140
8	5/16"	014 701 516	*	014 120 516	014 601 516
10	3/8"	014 701 380	*	014 120 380	014 601 380
13	1/2"	014 701 120	*	014 120 120	014 601 120
16	5/8"	014 701 580	*	014 120 580	014 601 580
19	3/4"	014 701 340	*	014 120 340	014 601 340
25	1"	014 701 100	*	014 120 100	014 601 100
32	1.1/4"	*	014 120 114	●	014 601 114 ●
38	1.1/2"	*	014 120 112	●	014 601 112 ●
50	2"	*	014 120 200	●	014 601 200 ●
60	2.1/2"	●	014 120 212	●	014 601 212
75	3"	●	014 120 300		

* Fornibile anche in Acciaio Inox / Also Stainless Steel available

**A SPELLARE
Skive**



Tubo / Hose		Tubo / Hose 1ST	Tubo / Hose 2ST-4SP-R9R	Tubo / Hose 4SH
DN	inch.	Codice / Part. nr.	Codice / Part. nr.	Codice / Part. nr.
5	3/16"	●*	014 801 316	●*
6	1/4"	●*	014 801 140	*
8	5/16"	●*	014 801 516	*
10	3/8"	●*	014 801 380	*
13	1/2"	●*	014 801 120	*
16	5/8"	●*	014 801 580	*
19	3/4"	●*	014 801 340	*
25	1"	●*	014 801 100	*
32	1.1/4"	●*	014 801 114	●*
38	1.1/2"	●*	014 801 112	●*
50	2"	●*	014 801 200	●*
60	2.1/2"		014 802 212	

* Fornibile anche in Acciaio Inox / Also Stainless Steel available



**Codici in neretto
NO Zinco-Nichel**



Tubo / Hose		Tubo / Hose R7	Tubo / Hose R7-TP1-R8-1SC ELEVATOR	Tubo / Hose TP2
DN	inch.	Codice / Part. nr.	Codice / Part. nr.	Codice / Part. nr.
3	1/8"	014 700 180		
4	5/32"	●	014 700 532	
5	3/16"	*	014 700 316	*
6	1/4"	*	014 700 140	*
8	5/16"	*	014 700 516	*
10	3/8"	*	014 700 380	*
13	1/2"	*	014 700 120	*
16	5/8"		*	
19	3/4"		*	
25	1"			

* Fornibile anche in Acciaio Inox / Also Stainless Steel available

**Codici in neretto
NO Zinco-Nichel**



Tubo / Hose		Tubo / Hose R6(1TE)-2TE	Tubo / Hose R3-R4-3TE	Tubo / Hose UNIVERSALE
DN	inch.	Codice / Part. nr.	Codice / Part. nr.	Codice / Part. nr.
5	3/16"			
6	1/4"	●	014 660 140	014 340 140
8	5/16"		014 660 516	014 340 516
10	3/8"		014 660 380	014 340 380
13	1/2"		014 660 120	014 340 120
16	5/8"		014 660 580	*
19	3/4"		014 660 340	014 340 340
25	1"		014 660 100	*
32	1.1/4"		014 660 114	*
38	1.1/2"	●	014 660 112	●*
50	2"	●	014 660 200	●*
60	2.1/2"			●*

* Fornibile anche in Acciaio Inox / Also Stainless Steel available



**Codici in neretto
NO Zinco-Nichel**



**Acciaio Inox
Stainless Steel**

**Acciaio Inox
Stainless Steel**

Tubo Hose		Tubo / Hose PTFE	Tubo / Hose PTFE CORRUGATO	Tubo / Hose PTFE	Tubo / Hose PTFE CORRUGATO
DN	inch.	Codice / Part. nr.	Codice / Part. nr.	Codice / Part. nr.	Codice / Part. nr.
3	1/8"	014 900 180			
5	3/16"	014 900 316		● X14 901 316	
6	1/4"	014 900 140		● X14 901 140	
8	5/16"	014 900 516		● X14 901 516	
10	3/8"	014 900 380	● 014 990 380	● X14 901 380	● X14 991 380
13	1/2"	014 900 120	● 014 990 120	● X14 901 120	● X14 991 120
16	5/8"	014 900 580	● 014 990 580	● X14 901 580	● X14 991 580
19	3/4"	014 900 340	● 014 990 340	● X14 901 340	● X14 991 340
25	1"	014 900 100	● 014 990 100	● X14 901 100	● X14 991 100
32	1.1/4"		● 014 990 114		● X14 991 114
38	1.1/2"		● 014 990 112		● X14 991 112
50	2"		● 014 990 200		● X14 991 200

● Fornibile in 7 gg lavorativi / Available in 7 working days



**Codici in neretto
NO Zinco-Nichel**



Tubo Hose		Filetto Thread	Tubo / Hose PTFE CORRUGATO	Tubo / Hose PTFE	Tubo / Hose PTFE CORRUGATO
DN	inch.	inch.	Codice / Part. nr.	Codice / Part. nr.	Codice / Part. nr.
3	1/8"	G 1/8"-28	210 100 202	290 100 202	
3	1/8"	G 1/4"-19	210 100 204		
4	5/32"	G 1/8"-28	210 100 212		
5	3/16"	G 1/8"-28	*▲ 210 100 302	* 290 100 302	* 245 100 302
5	3/16"	G 1/4"-19	* 210 100 304	* 290 100 304	* 245 100 304
6	1/4"	G 1/8"-28	* 210 100 402	* 290 100 402	* 245 100 402
6	1/4"	G 1/4"-19	*▲ 210 100 404	*▲ 290 100 404	*▲ 245 100 404
6	1/4"	G 3/8"-19	*▲ 210 100 406	*▲ 290 100 406	*▲ 245 100 406
6	1/4"	G 1/2"-14	210 100 408	290 100 408	245 100 408
8	5/16"	G 1/4"-19	210 100 504	290 100 504	245 100 504
8	5/16"	G 3/8"-19	*▲ 210 100 506	*▲ 290 100 506	*▲ 245 100 506
8	5/16"	G 1/2"-14	210 100 508	290 100 508	245 100 508
10	3/8"	G 1/4"-19	210 100 604	290 100 604	245 100 604
10	3/8"	G 3/8"-19	*▲ 210 100 606	*▲ 290 100 606	*▲ 245 100 606
10	3/8"	G 1/2"-14	*▲ 210 100 608	*▲ 290 100 608	*▲ 245 100 608
13	1/2"	G 3/8"-19	210 100 806	290 100 806	245 100 806
13	1/2"	G 1/2"-14	*▲ 210 100 808	*▲ 290 100 808	*▲ 245 100 808
13	1/2"	G 5/8"-14	210 100 810	290 100 810	245 100 810
13	1/2"	G 3/4"-14	210 100 812	290 100 812	245 100 812
16	5/8"	G 1/2"-14	210 101 008	290 101 008	245 101 008
16	5/8"	G 5/8"-14	210 101 010	290 101 010	245 101 010
16	5/8"	G 3/4"-14	* 210 101 012	290 101 012	* 245 101 012
19	3/4"	G 1/2"-14	210 101 208	290 101 208	
19	3/4"	G 5/8"-14	210 101 210	290 101 210	
19	3/4"	G 3/4"-14	* 210 101 212	290 101 212	* 245 101 212
19	3/4"	G 1"-11	* 210 101 216	290 101 216	* 245 101 216
25	1"	G 3/4"-14	210 101 612	290 101 612	* 245 101 612
25	1"	G 1"-11	* 210 101 616	290 101 616	* 245 101 616
25	1"	G 1.1/4"-11	* 210 101 620	290 101 620	* 245 101 620
32	1.1/4"	G 1.1/4"-11	* 210 102 020	290 102 020	* 245 102 020
32	1.1/4"	G 1.1/2"-11	* 210 102 024	290 102 024	* 245 102 024
38	1.1/2"	G 1.1/2"-11	* 210 102 424	290 102 424	● 245 102 424
38	1.1/2"	G 2"-11	* 210 102 432	290 102 432	●* 245 102 432
50	2"	G 2"-11	210 103 232	290 103 232	245 103 232
60	2.1/2"	G 2.1/2"-11	● 210 104 040		
75	3"	G 3"-11	210 104 848		

* Fornibile anche in Acciaio Inox / Also Stainless Steel available

● Fornibile in 7 gg lavorativi / Available in 7 working days



Codici in neretto
NO Zinco-Nichel



Tubo Hose		Filetto Thread	Femmina DKR90 compatta DKR90 compact Female	Maschio cil. AGR AGR BSP Male	Maschio conico AGR K AGR K BSPT Male
DN	inch.	inch.	Codice / Part. nr.	Codice / Part. nr.	Codice / Part. nr.
3	1/8"	G 1/8"-28		200 100 202	
5	3/16"	G 1/8"-28	*	200 100 302	●*
5	3/16"	G 1/4"-19	*	200 100 304	●*
6	1/4"	G 1/8"-28	*	200 100 402	●*
6	1/4"	G 1/4"-19	291 160 404	*	200 100 404
6	1/4"	G 3/8"-19	●	291 160 406	*
6	1/4"	G 1/2"-14		200 100 408	
8	5/16"	G 1/4"-19		200 100 504	●
8	5/16"	G 3/8"-19	●	291 160 506	*
8	5/16"	G 1/2"-14		200 100 508	
10	3/8"	G 1/4"-19		200 100 604	●
10	3/8"	G 3/8"-19	291 160 606	*	200 100 606
10	3/8"	G 1/2"-14	●	291 160 608	●*
13	1/2"	G 3/8"-19		200 100 806	●
13	1/2"	G 1/2"-14	291 160 808	*	200 100 808
13	1/2"	G 5/8"-14		200 100 810	
13	1/2"	G 3/4"-14		200 100 812	●
16	5/8"	G 1/2"-14		200 101 008	●
16	5/8"	G 5/8"-14	●	291 161 010	
16	5/8"	G 3/4"-14	*	200 101 012	●*
19	3/4"	G 1/2"-14		200 101 208	
19	3/4"	G 5/8"-14		200 101 210	
19	3/4"	G 3/4"-14	291 161 212	*	200 101 212
19	3/4"	G 1"-11	*	200 101 216	●*
25	1"	G 3/4"-14		200 101 612	
25	1"	G 1"-11	291 161 616	*	200 101 616
25	1"	G 1.1/4"-11	*	200 101 620	●*
32	1.1/4"	G 1.1/4"-11	*	200 102 020	●*
32	1.1/4"	G 1.1/2"-11	*	200 102 024	●*
38	1.1/2"	G 1.1/2"-11	*	200 102 424	●*
38	1.1/2"	G 2"-11	*	200 102 432	
50	2"	G 2"-11	*	200 103 232	●*
60	2.1/2"	G 2.1/2"-11	●	200 104 040	
75	3"	G 3"-11	●	200 104 848	

* Fornibile anche in Acciaio Inox / Also Stainless Steel available



Codici in neretto
NO Zinco-Nichel



Tubo Hose		Filetto Thread	Femmina DKR F DKR F Female	Femmina DKR F 90 DKR F 90 Female	Femmina DKR F 45 DKR F 45 Female
DN	inch.	inch.	Codice / Part. nr.	Codice / Part. nr.	Codice / Part. nr.
6	1/4"	G 1/4"-19	210 160 404	290 160 404	
6	1/4"	G 3/8"-19	●	210 160 406	
8	5/16"	G 1/4"-19	●	210 160 504	
8	5/16"	G 3/8"-19	●	210 160 506	
10	3/8"	G 3/8"-19	210 160 606	290 160 606	●
10	3/8"	G 1/2"-14	210 160 608		
10	3/8"	21,7			
13	1/2"	G 1/2"-14	210 160 808	290 160 808	●
13	1/2"	21,7	●	210 160 821	
13	1/2"	G 5/8"-14	●	210 160 810	
13	1/2"	G 3/4"-14	●	210 160 812	
16	5/8"	G 5/8"-14	●	210 161 010	
16	5/8"	G 3/4"-14	●	210 161 012	
19	3/4"	3/4"-14	210 161 212	290 161 212	
19	3/4"	1"-11	●	210 161 216	
25	1"	1"-11	210 161 616	290 161 616	
32	1.1/4"	1.1/4"-11	●	210 162 020	●
38	1.1/2"	1.1/2"-11	●	210 162 424	●

RACCORDI BSPP SEDE PIANA / NPT



**Maschio Sede Piana
BSPP Male**
Codici in neretto
NO Zinco-Nichel



**Maschio NPTF
NPTF Male**
Codici in neretto
NO Zinco-Nichel



Tubo Hose		Filetto Thread	Maschio cil. AGR F AGR F BSPP Male
DN	inch.	inch.	Codice / Part. nr.
6	1/4"	G 1/4"-19	● 200 160 404
6	1/4"	G 3/8"-19	● 200 160 406
8	5/16"	G 3/8"-19	● 200 160 506
10	3/8"	G 3/8"-19	● 200 160 606
10	3/8"	G 1/2"-14	● 200 160 608
10	3/8"	21,7	● 200 160 621
13	1/2"	G 1/2"-14	● 200 160 808
13	1/2"	21,7	● 200 160 821
13	1/2"	G 3/4"-14	● 200 160 812
16	5/8"	G 5/8"-14	● 200 161 010
16	5/8"	G 3/4"-14	● 200 161 012
19	3/4"	G 3/4"-14	● 200 161 212
19	3/4"	G 1"-11	● 200 161 216
32	1.1/4"	G 1.1/4"-11	● 200 162 020
38	1.1/2"	G 1.1/2"-11	● 200 162 424

Tubo Hose		Filetto Thread	Maschio NPTF AGN AGN NPTF Male
DN	inch.	inch.	Codice / Part. nr.
5	3/16"	1/8"-27	● 200 140 302
5	3/16"	1/4"-18	● 200 140 304
6	1/4"	1/8"-27	● 200 140 402
6	1/4"	1/4"-18	● 200 140 404
6	1/4"	3/8"-18	● 200 140 406
8	5/16"	1/4"-18	● 200 140 504
8	5/16"	3/8"-18	● 200 140 506
8	5/16"	1/2"-14	● 200 140 508
10	3/8"	1/4"-18	● 200 140 604
10	3/8"	3/8"-18	● 200 140 606
10	3/8"	1/2"-14	● 200 140 608
13	1/2"	3/8"-18	● 200 140 806
13	1/2"	1/2"-14	● 200 140 808
13	1/2"	3/4"-14	● 200 140 812
16	5/8"	1/2"-14	● 200 141 008
16	5/8"	3/4"-14	● 200 141 012
19	3/4"	1/2"-14	● 200 141 208
19	3/4"	3/4"-14	● 200 141 212
19	3/4"	1"-11,5	● 200 141 216
25	1"	3/4"-14	● 200 141 612
25	1"	1"-11,5	● 200 141 616
25	1"	1.1/4"-11,5	● 200 141 620
32	1.1/4"	1.1/4"-11,5	● 200 142 020
32	1.1/4"	1.1/2"-11,5	● 200 142 024
38	1.1/2"	1.1/4"-11,5	● 200 142 424
38	1.1/2"	1.1/2"-11,5	● 200 142 432
50	2"	2"-11,5	● 200 143 232

● Fornibile in 7 gg lavorativi / Available in 7 working days



RACCORDI JIC SEDE 74

**Codici in neretto
NO Zinco-Nichel**



Tubo Hose		Filetto Thread	Femmina DKJ DKJ Female	Femmina DKJ90 DKJ90 Female	Femmina DKJ45 DKJ45 Female
DN	inch.	inch.	Codice / Part. nr.	Codice / Part. nr.	Codice / Part. nr.
3	1/8"	7/16"-20 UNF	210 200 204		
5	3/16"	7/16"-20 UNF	210 200 304	290 200 304	● 245 200 304
5	3/16"	1/2"-20 UNF	210 200 305	290 200 305	● 245 200 305
6	1/4"	7/16"-20 UNF *	210 200 404	* 290 200 404	* 245 200 404
6	1/4"	1/2"-20 UNF *	210 200 405	* 290 200 405	* 245 200 405
6	1/4"	9/16"-18 UNF *	210 200 406	* 290 200 406	* 245 200 406
8	5/16"	1/2"-20 UNF	210 200 505	290 200 505	245 200 505
8	5/16"	9/16"-18 UNF *	210 200 506	* 290 200 506	* 245 200 506
8	5/16"	5/8"-18 UNF	210 200 507	290 200 507	245 200 507
8	5/16"	3/4"-16 UNF	210 200 508	290 200 508	245 200 508
10	3/8"	9/16"-18 UNF *	210 200 606	* 290 200 606	* 245 200 606
10	3/8"	5/8"-18 UNF	210 200 607	290 200 607	245 200 607
10	3/8"	3/4"-16 UNF *	210 200 608	* 290 200 608	* 245 200 608
10	3/8"	7/8"-14 UNF	210 200 610	290 200 610	245 200 610
13	1/2"	9/16"-18 UNF	210 200 806		
13	1/2"	3/4"-16 UNF *	210 200 808	* 290 200 808	* 245 200 808
13	1/2"	7/8"-14 UNF *	210 200 810	* 290 200 810	* 245 200 810
13	1/2"	1.1/16"-12 UN	210 200 812	290 200 812	245 200 812
16	5/8"	3/4"-16 UNF	210 201 008		
16	5/8"	7/8"-14 UNF *	210 201 010	* 290 201 010	* 245 201 010
16	5/8"	1.1/16"-12 UN *	210 201 012	* 290 201 012	* 245 201 012
19	3/4"	3/4"-16 UNF ●	210 201 208		
19	3/4"	7/8"-14 UNF	210 201 210	290 201 210	● 245 201 210
19	3/4"	1.1/16"-12 UN *	210 201 212	* 290 201 212	* 245 201 212
19	3/4"	1.3/16"-12 UN	210 201 214	290 201 214	245 201 214
19	3/4"	1.5/16"-12 UN *	210 201 216	* 290 201 216	* 245 201 216
25	1"	1.1/16"-12 UN	210 201 612	290 201 612	● 245 201 612
25	1"	1.5/16"-12 UN *	210 201 616	* 290 201 616	* 245 201 616
25	1"	1.5/8"-12 UN *	210 201 620	* 290 201 620	* 245 201 620
32	1.1/4"	1.5/8"-12 UN *	210 202 020	* 290 202 020	* 245 202 020
32	1.1/4"	1.7/8"-12 UN	210 202 024	● 290 202 024	● 245 202 024
38	1.1/2"	1.7/8"-12 UN	210 202 424	● 290 202 424	● 245 202 424
38	1.1/2"	2.1/2"-12 UN ●	210 202 432	● 290 202 432	● 245 202 432
50	2"	2.1/2"-12 UN	210 203 232	● 290 203 232	● 245 203 232

* Fornibile anche in Acciaio Inox / Also Stainless Steel available

● Fornibile in 7 gg lavorativi / Available in 7 working days



**Codici in neretto
NO Zinco-Nichel**



Tubo Hose		Filetto Thread	Femm.DKJ90 compatta DKJ90 compact Female	Maschio AGJ AGJ Male
DN	inch.	inch.	Codice / Part. nr.	Codice / Part. nr.
5	3/16"	7/16"-20 UNF		200 200 304
5	3/16"	1/2"-20 UNF		200 200 305
6	1/4"	7/16"-20 UNF	● 290 210 404	* 200 200 404
6	1/4"	1/2"-20 UNF		* 200 200 405
6	1/4"	9/16"-19 UNF	● 290 210 406	* 200 200 406
6	1/4"	3/4"-16 UNF		● 200 200 408
8	5/16"	1/2"-20 UNF		200 200 505
8	5/16"	9/16"-18 UNF		* 200 200 506
8	5/16"	5/8"-18 UNF		200 200 507
8	5/16"	3/4"-16 UNF		200 200 508
10	3/8"	1/2"-20 UNF		200 200 605
10	3/8"	9/16"-18 UNF	● 290 210 606	* 200 200 606
10	3/8"	5/8"-18 UNF		200 200 607
10	3/8"	3/4"-16 UNF	● 290 210 608	* 200 200 608
10	3/8"	7/8"-14 UNF		200 200 610
13	1/2"	3/4"-16 UNF	● 290 210 808	* 200 200 808
13	1/2"	7/8"-14 UNF	● 290 210 810	* 200 200 810
13	1/2"	1.1/16"-12 UN		200 200 812
16	5/8"	3/4"-16 UNF		200 201 008
16	5/8"	7/8"-14 UNF		* 200 201 010
16	5/8"	1.1/16"-12 UN		* 200 201 012
19	3/4"	7/8"-14 UNF		200 201 210
19	3/4"	1.1/16"-12 UN	● 290 211 212	200 201 212
19	3/4"	1.3/16"-12 UN		200 201 214
19	3/4"	1.5/16"-12 UN		* 200 201 216
25	1"	1.1/16"-12 UN		200 201 612
25	1"	1.5/16"-12 UN	● 290 211 616	* 200 201 616
25	1"	1.5/8"-12 UN		* 200 201 620
32	1.1/4"	1.5/8"-12 UN		* 200 202 020
32	1.1/4"	1.7/8"-12 UN		● 200 202 024
38	1.1/2"	1.7/8"-12 UN		● 200 202 424
38	1.1/2"	2.1/2"-12 UN		● 200 202 432
50	2"	2.1/2"-12 UN		● 200 203 232

* Fornibile anche in Acciaio Inox / Also Stainless Steel available

● Fornibile in 7 gg lavorativi / Available in 7 working days



**Codici in neretto
NO Zinco-Nichel**



Tubo Hose		Filetto Thread	Femmina ORFS ORFS Female	Femmina ORFS 90 ORFS 90 Female	Femmina ORFS 45 ORFS 45 Female	Maschio ORFS ORFS Male
DN	inch.	inch.	Codice / Part. nr.	Codice / Part. nr.	Codice / Part. nr.	Codice / Part. nr.
6	1/4"	9/16"-18 UNF	210 600 409	290 600 409	245 600 409	200 600 409
6	1/4"	11/16"-16 UN	210 600 411	290 600 411	245 600 411	200 600 411
8	5/16"	9/16"-18 UN	210 600 509	290 600 509	245 600 509	
8	5/16"	11/16"-16 UN	210 600 511	290 600 511	● 245 600 511	200 600 511
10	3/8"	9/16"-18 UNF	210 600 609	290 600 609	245 600 609	
10	3/8"	11/16"-16 UN	210 600 611	290 600 611	● 245 600 611	200 600 611
10	3/8"	13/16"-16 UN	210 600 613	290 600 613	245 600 613	200 600 613
13	1/2"	11/16"-16 UN	210 600 811			
13	1/2"	13/16"-16 UN	210 600 813	290 600 813	245 600 813	200 600 813
13	1/2"	1"-14 UNS	210 600 816	290 600 816	245 600 816	200 600 816
13	1/2"	1.3/16"-12 UN	210 600 819	290 600 819		200 600 819
16	5/8"	1"-14 UNS	210 601 016	290 601 016	245 601 016	200 601 016
16	5/8"	1.3/16"-12 UN	210 601 019	290 601 019	245 601 019	200 601 019
19	3/4"	1.3/16"-12 UN	● 210 601 219	● 290 601 219	● 245 601 219	200 601 219
19	3/4"	1.7/16"-12 UN	210 601 223	290 601 223	245 601 223	200 601 223
25	1"	1.3/16"-12 UN				● 200 601 619
25	1"	1.7/16"-12 UN	210 601 623	290 601 623	245 601 623	200 601 623
25	1"	1.11/16"-12 UN	210 601 627	290 601 627	245 601 627	
32	1.1/4"	1.11/16"-12 UN	210 602 027	290 602 027	245 602 027	● 200 602 027
38	1.1/2"	2"-12 UN	● 210 602 432	● 290 602 432	● 245 602 432	● 200 602 432

O-Ring	Ø	Codice / Part. nr.	Px. / Pcs.
	9/16"	903 011 000	50
	11/16"	903 012 000	50
	13/16"	903 014 000	50
	1"	903 016 000	50
	1.3/16"	903 018 000	25
	1.7/16"	903 021 000	25
	1.11/16"	903 025 000	10
	2"	903 029 000	10



● Fornibile in 7 gg lavorativi / Available in 7 working days



SERIE LEGGERA
Light Series

Codici in neretto
NO Zinco-Nichel



Tube Hose	Filetto Thread	Femmina DKOL DKOL Female	Femmina DKOL 90 DKOL 90 Female	Femmina DKOL 45 DKOL 45 Female	Maschio CEL CEL Male		
DN	inch.	inch.	Ø	Codice / Part. nr.	Codice / Part. nr.	Codice / Part. nr.	Codice / Part. nr.
3	1/8"	M 12x1,5	6L	210 402 122			
5	3/16"	M 12x1,5	6L *	210 403 122	* 290 403 122	* 245 403 122	* 200 403 122
5	3/16"	M 14x1,5	8L	210 403 142	290 403 142	245 403 142	200 403 142
6	1/4"	M 12x1,5	6L *	210 404 122	* 290 404 122	* 245 404 122	* 200 404 122
6	1/4"	M 14x1,5	8L *	210 404 142	* 290 404 142	* 245 404 142	* 200 404 142
6	1/4"	M 16x1,5	10L *	210 404 162	* 290 404 162	* 245 404 162	* 200 404 162
6	1/4"	M 18x1,5	12L *	210 404 182	* 290 404 182	* 245 404 182	* 200 404 182
8	5/16"	M 14x1,5	8L	210 405 142			200 405 142
8	5/16"	M 16x1,5	10L	210 405 162	290 405 162	245 405 162	200 405 162
8	5/16"	M 18x1,5	12L	210 405 182	290 405 182	245 405 182	200 405 182
10	3/8"	M 14x1,5	8L	210 406 142	290 406 142		
10	3/8"	M 16x1,5	10L	210 406 162	290 406 162	245 406 162	200 406 162
10	3/8"	M 18x1,5	12L *	210 406 182	* 290 406 182	* 245 406 182	* 200 406 182
10	3/8"	M 22x1,5	15L	210 406 222	290 406 222	245 406 222	200 406 222
10	3/8"	M 26x1,5	18L				200 406 262
13	1/2"	M 18x1,5	12L	210 408 182	290 408 182	245 408 182	200 408 182
13	1/2"	M 22x1,5	15L *	210 408 222	* 290 408 222	* 245 408 222	* 200 408 222
13	1/2"	M 26x1,5	18L	210 408 262	290 408 262	245 408 262	200 408 262
16	5/8"	M 22x1,5	15L				200 410 222
16	5/8"	M 26x1,5	18L *	210 410 262	* 290 410 262	* 245 410 262	* 200 410 262
16	5/8"	M 30x2	22L	210 410 303	290 410 303	245 410 303	200 410 303
19	3/4"	M 26x1,5	18L	210 412 262	290 412 262	245 412 262	200 412 262
19	3/4"	M 30x2	22L *	210 412 303	* 290 412 303	* 245 412 303	* 200 412 303
19	3/4"	M 36x2	28L	210 412 363	290 412 363	245 412 363	
25	1"	M 36x2	28L *	210 416 363	290 416 363	* 245 416 363	* 200 416 363
25	1"	M 36x2	35L	210 416 453			
32	1.1/4"	M 45x2	35L *	210 420 453	290 420 453	245 420 453	* 200 420 453
32	1.1/4"	M 52x2	42L	210 420 523			
38	1.1/2"	M 52x2	42L *	210 424 523	290 424 523	245 424 523	* 200 424 523

* Fornibile anche in Acciaio Inox / Also Stainless Steel available

O-Ring	Ø	Codice / Part. nr.	Px. / Pcs.	Ø	Codice / Part. nr.	Px. / Pcs.
	6L/S	903 001 006	50	18L	903 001 018	50
	8L/S	903 001 008	50	22L	903 001 022	50
	10L/S	903 001 010	50	28L	903 001 028	25
	12L	903 001 012	50	35L	903 001 035	25
	15L	903 001 015	50	42L	903 001 042	25

● Fornibile in 7 gg lavorativi / Available in 7 working days



SERIE PESANTE
Heavy Series

Codici in neretto
NO Zinco-Nichel



Tube Hose	Filetto Thread	Femmina DKOS DKOS Female	Femmina DKOS90 DKOS 90 Female	Femmina DKOS45 DKOS 45 Female	Maschio CES CES Male		
DN	inch.	inch.	Ø	Codice / Part. nr.	Codice / Part. nr.	Codice / Part. nr.	Codice / Part. nr.
5	3/16"	M 14x1,5	6S	210 503 142	290 503 142	245 503 142	200 503 142
5	3/16"	M 16x1,5	8S *	210 503 162	* 290 503 162	* 245 503 162	* 200 503 162
6	1/4"	M 14x1,5	6S *	210 504 142	* 290 504 142	* 245 504 142	* 200 504 142
6	1/4"	M 16x1,5	8S *	210 504 162	* 290 504 162	* 245 504 162	* 200 504 162
6	1/4"	M 18x1,5	10S *	210 504 182	* 290 504 182	* 245 504 182	* 200 504 182
6	1/4"	M 20x1,5	12S	210 504 202	290 504 202	245 504 202	200 504 202
8	5/16"	M 16x1,5	8S	210 505 162			200 505 162
8	5/16"	M 18x1,5	10S	210 505 182	290 505 182	245 505 182	200 505 182
8	5/16"	M 20x1,5	12S	210 505 202	290 505 202	245 505 202	200 505 202
10	3/8"	M 18x1,5	10S	210 506 182	290 506 182	245 506 182	200 506 182
10	3/8"	M 20x1,5	12S *	210 506 202	* 290 506 202	* 245 506 202	* 200 506 202
10	3/8"	M 22x1,5	14S	210 506 222	290 506 222	245 506 222	200 506 222
10	3/8"	M 24x1,5	16S	210 506 242	290 506 242		200 506 242
13	1/2"	M 20x1,5	12S	210 508 202	290 508 202		
13	1/2"	M 22x1,5	14S *	210 508 222	* 290 508 222	* 245 508 222	* 200 508 222
13	1/2"	M 24x1,5	16S *	210 508 242	* 290 508 242	* 245 508 242	* 200 508 242
13	1/2"	M 30x2	20S	210 508 303	290 508 303		200 508 303
16	5/8"	M 24x1,5	16S	210 510 242			
16	5/8"	M 30x2	20S *	210 510 303	* 290 510 303	* 245 510 303	* 200 510 303
16	5/8"	M 36x2	25S	210 510 363	290 510 363	245 510 363	200 510 363
19	3/4"	M 30x2	20S *	210 512 303	* 290 512 303	* 245 512 303	* 200 512 303
19	3/4"	M 36x2	25S *	210 512 363	* 290 512 363	* 245 512 363	* 200 512 363
25	1"	M 36x2	25S *	210 516 363	* 290 516 363	245 516 363	* 200 516 363
25	1"	M 42x2	30S *	210 516 423	* 290 516 423	245 516 423	* 200 516 423
32	1.1/4"	M 42x2	30S	210 520 423	290 520 423	245 520 423	200 520 423
32	1.1/4"	M 52x2	38S *	210 520 523	* 290 520 523	245 520 523	200 520 523
38	1.1/2"	M 52x2	38S	210 524 523	290 524 523	245 524 523	200 524 523

* Fornibile anche in Acciaio Inox / Also Stainless Steel available

O-Ring	Ø	Codice / Part. nr.	Px. / Pcs.	Ø	Codice / Part. nr.	Px. / Pcs.
	6L/S	903 001 006	50	16S	903 001 016	50
	8L/S	903 001 008	50	20S	903 001 020	50
	10L/S	903 001 010	50	25S	903 001 025	25
	12S	903 001 112	50	30S	903 001 030	25
	14S	903 001 015	50	38S	903 001 038	25

● Fornibile in 7 gg lavorativi / Available in 7 working days

BOCCOLE & RACCORDI STANDARD

STANDARD FERRULES & FITTINGS

RACCORDI METRICI SEDE 60

CONICITÀ 60°
60° CONE

Codici in neretto
NO Zinco-Nichel



Tubo Hose		Filetto Thread	Femmina Metrica Metric Female	Femmina Metr. 90 Metric 90 Female	Femmina Metr. 45 Metric 45 Female	Maschio Metrico Metric Male
DN	inch.	inch.	Codice / Part. nr.	Codice / Part. nr.	Codice / Part. nr.	Codice / Part. nr.
5	3/16"	M 10x1	210 303 100	290 303 100	245 303 100	200 303 100
5	3/16"	M 12x1,5	210 303 122	290 303 122	245 303 122	200 303 122
6	1/4"	M 10x1	210 304 100	290 304 100	245 304 100	200 304 100
6	1/4"	M 12x1,5	210 304 122	290 304 122	245 304 122	200 304 122
6	1/4"	M 14x1,5	210 304 142	290 304 142	245 304 142	200 304 142
6	1/4"	M 16x1,5	210 304 162	290 304 162	245 304 162	200 304 162
6	1/4"	M 18x1,5	210 304 182	290 304 182	245 304 182	200 304 182
8	5/16"	M 14x1,5	210 305 142	290 305 142	245 305 142	200 305 142
8	5/16"	M 16x1,5	210 305 162	290 305 162	245 305 162	200 305 162
8	5/16"	M 18x1,5	210 305 182	290 305 182	245 305 182	200 305 182
10	3/8"	M 14x1,5	210 306 142	290 306 142	245 306 142	200 306 142
10	3/8"	M 16x1,5	210 306 162	290 306 162	245 306 162	200 306 162
10	3/8"	M 18x1,5	210 306 182	290 306 182	245 306 182	200 306 182
10	3/8"	M 20x1,5	210 306 202	290 306 202	245 306 202	200 306 202
10	3/8"	M 22x1,5	210 306 222	290 306 222	245 306 222	200 306 222
13	1/2"	M 16x1,5	210 308 162	290 308 162	245 308 162	200 308 162
13	1/2"	M 18x1,5	210 308 182	290 308 182	245 308 182	200 308 182
13	1/2"	M 20x1,5	210 308 202	290 308 202	245 308 202	200 308 202
13	1/2"	M 22x1,5	210 308 222	290 308 222	245 308 222	200 308 222
13	1/2"	M 24x1,5	210 308 242	290 308 242	245 308 242	200 308 242
13	1/2"	M 26x1,5	210 308 262	290 308 262	245 308 262	200 308 262
16	5/8"	M 24x1,5	210 310 242	290 310 242	245 310 242	200 310 242
16	5/8"	M 26x1,5	210 310 262	290 310 262	245 310 262	200 310 262
16	5/8"	M 27x1,5	210 310 272	290 310 272	245 310 272	200 310 272
19	3/4"	M 26x1,5	210 312 262	290 312 262	245 312 262	200 312 262
19	3/4"	M 30x1,5	210 312 302	290 312 302	245 312 302	200 312 302
25	1"	M 38x1,5	210 316 382	290 316 382	245 316 382	200 316 382
32	1.1/4"	M 45x1,5	210 320 452	290 320 452	245 320 452	200 320 452
38	1.1/2"	M 52x1,5	210 324 522	290 324 522	245 324 522	200 324 522

● Fornibile in 7 gg lavorativi / Available in 7 working days

BOCCOLE & RACCORDI STANDARD

STANDARD FERRULES & FITTINGS

RACCORDI ESTREMITÀ TUBOLARE

SERIE PESANTE
HEAVY SERIES

Codici in neretto
NO Zinco-Nichel



Tubo Hose		Codolo Ø Pipe Ø	Estremità Tubolare Standpipe	Estremità Tubolare 90° 90° Standpipe	Estremità Tubolare 45° 45° Standpipe
DN	inch.	mm	Codice / Part. nr.	Codice / Part. nr.	Codice / Part. nr.
3	1/8"	06L	202 800 206		
4	5/32"	06L	202 800 216	202 890 216	202 840 216
5	3/16"	04LL	202 800 304	202 890 304	202 840 304
5	3/16"	06L	202 800 306	202 890 306	202 840 306
5	3/16"	08S	202 800 308	202 890 308	
6	1/4"	06L	202 800 406	202 890 406	202 840 406
6	1/4"	08L/S	202 800 408	202 890 408	202 840 408
6	1/4"	10S	202 800 410	202 890 410	202 840 410
6	1/4"	12S	202 800 412	202 890 412	202 840 412
8	5/16"	08L	202 800 508	202 890 508	
8	5/16"	10L	202 800 510	202 890 510	202 840 510
8	5/16"	12S	202 800 512	202 890 512	202 840 512
10	3/8"	10L	202 800 610	202 890 610	202 840 610
10	3/8"	12L	202 800 612	202 890 612	202 840 612
10	3/8"	14S	202 800 614	202 890 614	202 840 614
10	3/8"	15L	202 800 615	202 890 615	202 840 615
10	3/8"	16S	202 800 616	202 890 616	
13	1/2"	12S	202 800 812	202 890 812	
13	1/2"	14S	202 800 814	202 890 814	202 840 814
13	1/2"	15L	202 800 815	202 890 815	202 840 815
13	1/2"	16S	202 800 816	202 890 816	202 840 816
13	1/2"	18L	202 800 818	202 890 818	202 840 818
13	1/2"	20S	202 800 820	202 890 820	
16	5/8"	18L	202 801 018	202 891 018	202 841 018
16	5/8"	20S	202 801 020	202 891 020	202 841 020
16	5/8"	22L	202 801 022	202 891 022	202 841 022
19	3/4"	18L	202 801 218	202 891 218	
19	3/4"	20S	202 801 220	202 891 220	202 841 220
19	3/4"	22L	202 801 222	202 891 222	202 841 222
19	3/4"	25S	202 801 225	202 891 225	202 841 225
25	1"	22L	202 801 622	202 891 622	202 841 622
25	1"	25S	202 801 625	202 891 625	202 841 625
25	1"	28L	202 801 628	202 891 628	202 841 628
25	1"	30S	202 801 630	202 891 630	202 841 630
32	1.1/4"	35L	202 802 035	202 892 035	202 842 035
32	1.1/4"	38S	202 802 038	202 892 038	202 842 038
38	1.1/2"	38S	202 802 438	202 892 438	202 842 438
38	1.1/2"	42L	202 802 442	202 892 442	202 842 442

● Fornibile in 7 gg lavorativi / Available in 7 working days



Codici in neretto
NO Zinco-Nichel



Tubo Hose		Filetto Thread	Femmina Komatsu Komatsu Female	Femm. Komatsu 90 Komatsu 90 Fem.	Femm. Komatsu 45 Komatsu 45 Fem.	Maschio Komatsu Komatsu Male
DN	inch.	inch.	Codice / Part. nr.	Codice / Part. nr.	Codice / Part. nr.	Codice / Part. nr.
6	1/4"	M 12x1,5	● 210 704 122	● 290 704 122		200 704 122
6	1/4"	M 14x1,5	210 704 142	290 704 142	245 704 142	200 704 142
6	1/4"	M 16x1,5	210 704 162	● 290 704 162	245 704 162	200 704 162
8	5/16"	M 14x1,5				200 705 142
8	5/16"	M 16x1,5	210 705 162	290 705 162	245 705 162	● 200 705 162
10	3/8"	M 14x1,5	● 210 706 142	290 706 142	245 706 142	
10	3/8"	M 16x1,5	210 706 162	290 706 162	245 706 162	200 706 162
10	3/8"	M 18x1,5	210 706 182	290 706 182	245 706 182	200 706 182
10	3/8"	M 20x1,5	210 706 202			200 706 202
13	1/2"	M 18x1,5	210 708 182	290 708 182	● 245 708 182	
13	1/2"	M 20x1,5	210 708 202	● 290 708 202	● 245 708 202	200 708 202
13	1/2"	M 22x1,5	210 708 222	290 708 222	● 245 708 222	200 708 222
13	1/2"	M 24x1,5	210 708 242	● 290 708 242	245 708 242	200 708 242
16	5/8"	M 22x1,5	● 210 710 222	290 710 222	245 710 222	
16	5/8"	M 24x1,5	210 710 242	● 290 710 242	● 245 710 242	200 710 242
19	3/4"	M 30x1,5	210 712 302	● 290 712 302	● 245 712 302	200 712 302
25	1"	M 33x1,5	● 210 716 332	● 290 716 332	● 240 716 332	● 200 716 332
32	1.1/4"	M 36x1,5	● 210 720 362	● 290 720 362	● 245 720 362	● 200 720 362
38	1.1/2"	M 42x1,5	● 210 724 422	● 290 724 422	● 245 724 422	● 200 724 422

RACCORDI BSP "TOYOTA" SEDE 60

Codici in neretto
NO Zinco-Nichel



Tubo Hose		Filetto Thread	Femmina Toyota Toyota Female	Femm. Toyota 90 Toyota 90 Fem.	Femm. Toyota 45 Toyota 45 Fem.	Maschio Toyota Toyota Male
DN	inch.	inch.	Codice / Part. nr.	Codice / Part. nr.	Codice / Part. nr.	Codice / Part. nr.
6	1/4"	1/4"	210 700 404	290 700 404	245 700 404	200 700 404
10	3/8"	3/8"	210 700 606	290 700 606	245 700 606	200 700 606
13	1/2"	1/2"	210 700 808	290 700 808	245 700 808	200 700 808
19	3/4"	3/4"	210 701 212	290 701 212	245 701 212	200 701 212
25	1"	1"	210 701 616	290 701 616	245 701 616	
32	1.1/4"	1.1/4"	210 702 020	290 702 020	245 702 020	
38	1.1/2"	1.1/2"	210 702 424	290 702 424	245 702 424	

● Fornibile in 7 gg lavorativi / Available in 7 working days



**OCCHIO PER VITE GAS
BSP BOLT BANJO**

Codici in neretto
NO Zinco-Nichel



Tubo Hose		Occhio Ø Banjo Ø	Occhio BSP RNR RNR BSP Banjo
DN	inch.	mm	Codice / Part. nr.
5	3/16"	G 1/8"	201 700 302
5	3/16"	G 1/4"	201 700 304
6	1/4"	G 1/8"	201 700 402
6	1/4"	G 1/4"	* 201 700 404
6	1/4"	G 3/8"	201 700 406
6	1/4"	G 1/2"	201 700 408
8	5/16"	G 1/4"	201 700 504
8	5/16"	G 3/8"	201 700 506
8	5/16"	G 1/2"	201 700 508
10	3/8"	G 1/4"	201 700 604
10	3/8"	G 3/8"	* 201 700 606
10	3/8"	G 1/2"	201 700 608
13	1/2"	G 3/8"	201 700 806
13	1/2"	G 1/2"	* 201 700 808
13	1/2"	G 5/8"	201 700 810
13	1/2"	G 3/4"	201 700 812
16	5/8"	G 1/2"	201 701 008
16	5/8"	G 5/8"	201 701 010
16	5/8"	G 3/4"	201 701 012
19	3/4"	G 1/2"	201 701 208
19	3/4"	G 3/4"	* 201 701 212
19	3/4"	G 1"	201 701 216
25	1"	G 1"	* 201 701 616
32	1.1/4"	G 1.1/4"	● 201 702 020

* Fornibile anche in Acciaio Inox
Also Stainless Steel available

**OCCHIO PER VITE METRICA
METRIC BOLT BANJO**

Codici in neretto
NO Zinco-Nichel



Tubo Hose		Occhio Ø Banjo Ø	Occhio BSP RNR RNR BSP Banjo
DN	inch.	mm	Codice / Part. nr.
5	3/16"	M 10	201 800 310
5	3/16"	M 12	201 800 312
5	3/16"	M 14	201 800 314
6	1/4"	M 8	● 201 800 408
6	1/4"	M 10	201 800 410
6	1/4"	M 12	201 800 412
6	1/4"	M 14	201 800 414
6	1/4"	M 16	201 800 416
6	1/4"	M 18	201 800 418
8	5/16"	M 12	201 800 512
8	5/16"	M 14	201 800 514
8	5/16"	M 16	201 800 516
8	5/16"	M 18	201 800 518
8	5/16"	M 20	201 800 520
8	5/16"	M 22	201 800 522
10	3/8"	M 12	201 800 612
10	3/8"	M 14	201 800 614
10	3/8"	M 16	201 800 616
10	3/8"	M 18	201 800 618
10	3/8"	M 20	201 800 620
10	3/8"	M 22	201 800 622
13	1/2"	M 16	201 800 816
13	1/2"	M 18	201 800 818
13	1/2"	M 20	201 800 820
13	1/2"	M 22	201 800 822
13	1/2"	M 26	201 800 826
16	5/8"	M 20	201 801 020
16	5/8"	M 22	201 801 022
16	5/8"	M 24	201 801 024
16	5/8"	M 26	201 801 026
19	3/4"	M 26	201 801 226
19	3/4"	M 30	201 801 230
25	1"	M 30	201 801 630

● Fornibile in 7 gg lavorativi / Available in 7 working days

BOCCOLE & RACCORDI STANDARD

STANDARD FERRULES & FITTINGS

RACCORDI FLANGIA SAE J518 - SERIE 3000



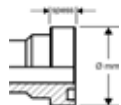

Codici in neretto
NO Zinco-Nichel



Tubo Hose		Flangia Ø Flange Ø			Flangia FL3 Diritta FL3 Straight Flange	Flangia FL3 90 FL3 90 Flange	Flangia FL3 45 FL3 45 Flange
DN	inch.	inch.	mm	spess.	Codice / Part. nr.	Codice / Part. nr.	Codice / Part. nr.
13	1/2"	1/2"	30,2	6,7	* 210 930 808	* 290 930 808	* 245 930 808
13	1/2"	5/8"	34,0	6,7	210 930 810	290 930 810	245 930 810
13	1/2"	3/4"	38,1	6,7	210 930 812	290 930 812	245 930 812
16	5/8"	1/2"	30,2	6,7	210 931 008	290 931 008	● 245 931 008
16	5/8"	5/8"	34,0	6,7	210 931 010	290 931 010	245 931 010
16	5/8"	3/4"	38,1	6,7	210 931 012	290 931 012	● 245 931 012
19	3/4"	1/2"	30,2	6,7	● 210 931 208	● 290 931 208	245 931 208
19	3/4"	3/4"	38,1	6,7	* 210 931 212	* 290 931 212	* 245 931 212
19	3/4"	1"	44,5	8,0	* 210 931 216	* 290 931 216	* 245 931 216
19	3/4"	1.1/4"	50,8	8,0		290 931 220	
25	1"	3/4"	38,1	6,7	210 931 612	290 931 612	245 931 612
25	1"	1"	44,5	8,0	* 210 931 616	* 290 931 616	* 245 931 616
25	1"	1.1/4"	50,8	8,0	* 210 931 620	* 290 931 620	* 245 931 620
32	1.1/4"	1"	44,5	8,0	● 210 932 016	● 290 932 016	● 245 932 016
32	1.1/4"	1.1/4"	50,8	8,0	* 210 932 020	* 290 932 020	* 245 932 020
32	1.1/4"	1.1/2"	60,3	8,0	* 210 932 024	* 290 932 024	245 932 024
38	1.1/2"	1.1/4"	50,8	8,0			245 932 420
38	1.1/2"	1.1/2"	60,3	8,0	* 210 932 424	* 290 932 424	* 245 932 424
38	1.1/2"	2"	71,4	9,5	●* 210 932 432	●* 290 932 432	●* 245 932 432
50	2"	2"	71,4	9,5	●* 210 933 232	* 290 933 232	* 245 933 232
50	2"	2.1/2"	84,1	9,5	● 210 933 240		
60	2.1/2"	2.1/2"	84,1	9,5	● 210 934 040	● 290 934 040	
75	3"	3"	101,6	9,5	● 210 934 848	● 290 934 848	

* Fornibile anche in Acciaio Inox/Also Stainless Steel available

SAE 3000/6000

O-Ring	Ø	Codice / Part. nr.	Pz. / Pcs.	O-Ring	Ø	Codice / Part. nr.	Pz. / Pcs.
	1/2"	903 210 000	25		1/2"	993 210 000	10
	3/4"	903 214 000	25		3/4"	993 214 000	10
	1"	903 219 000	25		1"	993 219 000	10
	1.1/4"	903 222 000	25		1.1/4"	993 222 000	10
	1.1/2"	903 225 000	10		1.1/2"	993 225 000	5
	2"	903 228 000	10		2"	993 228 000	5
	2.1/2"	903 232 000	5				
	3"	903 237 000	5				
	3.1/2"	903 241 000	5				

● Fornibile in 7 gg lavorativi / Available in 7 working days

BOCCOLE & RACCORDI STANDARD

STANDARD FERRULES & FITTINGS

RACCORDI FLANGIA SAE J518 - SERIE 6000





Codici in neretto
NO Zinco-Nichel



Tubo Hose		Flangia Ø Flange Ø			Flangia FL6 Diritta FL6 Straight Flange	Flangia FL6 90 FL6 90 Flange	Flangia FL6 45 FL6 45 Flange
DN	inch.	inch.	mm	spess.	Codice / Part. nr.	Codice / Part. nr.	Codice / Part. nr.
13	1/2"	1/2"	31,7	7,8	●* 210 960 808	●* 290 960 808	●* 245 960 808
13	1/2"	3/4"	41,3	8,8	● 210 960 812	● 290 960 812	● 245 960 812
16	5/8"	1/2"	31,7	7,8	210 961 008	● 290 961 008	● 245 961 008
16	5/8"	3/4"	41,3	8,8	● 210 961 012	● 290 961 012	● 245 961 012
19	3/4"	1/2"	31,7	7,8	210 961 208	290 961 208	245 961 208
19	3/4"	3/4"	41,3	8,8	* 210 961 212	* 290 961 212	* 245 961 212
19	3/4"	1"	47,6	9,5	* 210 961 216	* 290 961 216	* 245 961 216
25	1"	3/4"	41,3	8,8	● 210 961 612	290 961 612	245 961 612
25	1"	1"	47,6	9,5	* 210 961 616	* 290 961 616	* 245 961 616
25	1"	1.1/4"	54,0	10,3	* 210 961 620	* 290 961 620	* 245 961 620
32	1.1/4"	1"	47,6	9,5	210 962 016	290 962 016	245 962 016
32	1.1/4"	1.1/4"	54,0	10,3	* 210 962 020	* 290 962 020	* 245 962 020
32	1.1/4"	1.1/2"	63,5	12,6	* 210 962 024	●* 290 962 024	●* 245 962 024
38	1.1/2"	1.1/2"	63,5	12,6	* 210 962 424	* 290 962 424	* 245 962 424
38	1.1/2"	2"	79,4	12,6	●* 210 962 432	●* 290 962 432	●* 245 962 432
50	2"	2"	79,4	12,6	* 210 963 232	●* 290 963 232	●* 245 963 232

* Fornibile anche in Acciaio Inox/Also Stainless Steel available



SAE 3000/6000

O-Ring	Ø	Codice / Part. nr.	Pz. / Pcs.	O-Ring	Ø	Codice / Part. nr.	Pz. / Pcs.
	1/2"	903 210 000	25		1/2"	993 210 000	10
	3/4"	903 214 000	25		3/4"	993 214 000	10
	1"	903 219 000	25		1"	993 219 000	10
	1.1/4"	903 222 000	25		1.1/4"	993 222 000	10
	1.1/2"	903 225 000	10		1.1/2"	993 225 000	5
	2"	903 228 000	10		2"	993 228 000	5

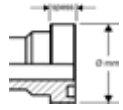
● Fornibile in 7 gg lavorativi / Available in 7 working days



Tubo Hose		Flangia Ø Flange Ø			Flangia FL9 Diritta FL9 Straight Flange	Flangia FL9 90 FL9 90 Flange	Flangia FL9 45 FL9 45 Flange
DN	inch.	inch.	mm	spess.	Codice / Part. nr.	Codice / Part. nr.	Codice / Part. nr.
19	3/4"	3/4"	41,3	14,2	210 991 212	290 991 212	245 991 212
19	3/4"	1"	47,6	14,2	210 991 216	290 991 216	245 991 216
25	1"	1"	47,6	14,2	210 991 616	290 991 616	245 991 616
25	1"	1.1/4"	54,0	14,2	210 991 620	290 991 620	245 991 620
32	1.1/4"	1.1/4"	54,0	14,2	210 992 020	290 992 020	245 992 020
32	1.1/4"	1.1/2"	63,5	14,2	210 992 024	290 992 024	245 992 024
38	1.1/2"	1.1/2"	63,5	14,2	210 992 424	290 992 424	245 992 424

O-Ring	Ø	Codice / Part. nr.	Pz. / Pcs.	O-Ring	Ø	Codice / Part. nr.	Pz. / Pcs.
	3/4"	903 214 000	25		3/4"	993 214 000	10
	1"	903 219 000	25		1"	993 219 000	10
	1.1/4"	903 222 000	25		1.1/4"	993 222 000	10
	1.1/2"	903 225 000	10		1.1/2"	993 225 000	5



● Fornibile in 7 gg lavorativi / Available in 7 working days



Dimensioni Dimensions				Semi flange SAE 3000 SAE 3000 Flange Halves	Semi flange SAE 6000 SAE 6000 Flange Halves	Semi flange SAE 9000 SAE 9000 Flange Halves
inch.	A	B	C	Codice / Part. nr.	Codice / Part. nr.	Codice / Part. nr.
1/2"	38,1	54,0	6,2	209 930 808		
1/2"	40,5	57,0	7,2		209 960 808	
3/4"	47,6	65,0	6,2	209 931 212		
3/4"	50,8	72,0	8,3		209 961 212	
3/4"	50,8	70,0	13,5			209 991 212
1"	52,4	70,0	7,5	209 931 616		
1"	57,2	81,0	9,0		209 961 616	
1"	57,2	79,0	13,5			209 991 616
1.1/4"	58,7	80,0	7,5	209 932 020		
1.1/4"	66,5	96,0	9,8		209 962 020	
1.1/4"	66,7	94,0	13,5			209 992 020
1.1/2"	69,9	94,0	7,5	209 932 424		
1.1/2"	79,4	113,0	12,1		209 962 424	
1.1/2"	79,4	109,0	13,5			209 992 424
2"	77,8	102,0	9,0	209 933 232		
2"	96,8	134,0	12,1		209 963 232	
2.1/2"	88,9	114,0	9,0	209 934 040		
3"	106,4	135,0	9,0	209 934 848		

* Fornibile anche in Acciaio Inox / Also Stainless Steel available

RACCORDO GIUNZIONE TUBO

Tubo Hose	Giunzione Tubo-Tubo Double Connector	
DN	inch.	Codice / Part. nr.
5	3/16"	190 000 303
6	1/4"	190 000 404
8	5/16"	190 000 505
10	3/8"	190 000 606
13	1/2"	190 000 808
16	5/8"	190 001 010
20	3/4"	190 001 212
25	1"	190 001 616
32	1.1/4"	190 002 020



● Fornibile in 7 gg lavorativi / Available in 7 working days

RACCORDI FLANGIA - SERIE SUPERCAT



Codici in neretto
NO Zinco-Nichel



Tubo Hose		Filetto Thread		Femmina con Girella Female with swivel nut	Codolo senza Girella Pipe without swivel nut	Maschio per Pistola Gun Male
DN	inch.	inch.	Ø	Codice / Part. nr.	Codice / Part. nr.	Codice / Part. nr.
6	1/4"	M 22x1,5	14	210 001 140	200 003 140	
6	1/4"	M 22x1,5	15	210 002 140		
6	1/4"		10			200 102 140
6	1/4"		11			200 103 140
8	5/16"	M 22x1,5	14	210 001 516	200 003 516	
8	5/16"	M 22x1,5	15	210 002 516		
8	5/16"		10			200 102 516
8	5/16"		11			200 103 516
10	3/8"	M 22x1,5	14	210 001 380		



Filetto Thread	Girella Corta Short swivel nut	Girella Lunga Long swivel nut
inch.	Codice / Part. nr.	Codice / Part. nr.
M 22x1,5	201 005 000	201 005 100



Tubo Hose		Foro Ø Hole Ø	Femmina con Girella Female with swivel nut	Codolo senza Girella Pipe without swivel nut
DN	inch.	mm	Codice / Part. nr.	Codice / Part. nr.
6	1/4"	16	100 700 016	100 701 016
8	5/16"	18	100 700 018	100 701 018
10	3/8"	21	100 700 021	100 701 021
13	1/2"	22	100 700 022	100 701 022

Adattatori
Adapters
PAG 321



● Fornibile in 7 gg lavorativi / Available in 7 working days



RACCORDI PER TUBO FLESSIBILE
FLEXIBLE HOSE FITTINGS

SISTEMA WEO PLUG-IN
PLUG-IN WEO SYSTEM

**SISTEMA PLUG-IN
PER UNA RAPIDA
CONNESSIONE A SCATTO**
Plug-In System
for Fast connection Snap



VANTAGGI

I prodotti WEO Plug-In sono caratterizzati da una connessione istantanea e autoallineante che li rende facili da installare in un sistema idraulico. Inoltre, gli incidenti sul lavoro associati al collegamento/scollegamento o a ulteriori serraggi di raccordi sono eliminati. Grazie al semplice collegamento e scollegamento istantaneo degli attacchi Weo è necessario solo un semplice cacciavite per la manutenzione o la sostituzione dei ricambi.

Un macchinario equipaggiato con WEO vi permetterà di risparmiare tempo e denaro. Grazie alla caratteristica di auto-allineamento degli inserti si eliminano problemi di attorcigliamento dei tubi flessibili, allungandone la durata di servizio. Qualora lo scollegamento dei tubi si rendesse necessario è sufficiente utilizzare, molto semplicemente, un normale cacciavite. Quando innestati, gli inserti garantiscono una connessione a perdita zero e un circuito idraulico senza ostruzioni. La garanzia di una corretta connessione degli inserti è assicurata, senza preoccupazioni di post-serraggi ulteriori.

Il sistema WEO è già montato da: **Komatsu, Palfinger, Volvo, Atlas Copco, Class, Fassi, produttori di ragni, ecc.**

DATI TECNICI

- Test: Gli inserti per tubi flessibili WEO Plug-In sono stati testati ed approvati dall'Istituto Svedese per il Controllo e la Ricerca dei materiali a norma SS-ISO 8032 - Half Omega Test ad una pressione minima di scoppio quattro volte superiore alla pressione di esercizio. Inoltre, gli inserti sono stati testati ed approvati dall'ente TÜV, Germania.
- Materiale guarnizione: Nitrile (NBR), altre guarnizioni disponibili su richiesta.
- Temperature di utilizzo: -30°C 100°C -22°F212°F
- Pressione di esercizio, Fattore di sicurezza: Gli inserti WEO nelle misure da 1/4" a 3/4" hanno una pressione max di esercizio di 350 bar (5076 PSI). La misura da 1" ha una pressione max di esercizio di 250 bar (3625 PSI). A tutte le misure è applicato un fattore minimo di sicurezza di 4:1 tra pressione di scoppio e pressione di esercizio.

ADVANTAGE

WEO Plug-Ins have click-to-connect and self-aligning features that make them easy to install in hydraulic systems. In addition, work injuries associated with connection/disconnection and follow-up tightening/untightening are eliminated. With the simple connection and disconnection of the WEO fittings, only a common screwdriver is needed for service or assembly replacements.

A machine equipped WEO will save you both time and money. Due to the fact that WEO fittings are self-aligning, twisted hose is no longer a problem giving your hose an extend service life. If necessary, disconnection can be achieved using nothing more than a simple screw driver, it's as easy as that! When plugged back in, the tight connection ensures leakage is virtually eliminated leaving you with a clog-free system. You can always rest assured the fittings are properly plugged in and don't have to worry about re-tightening.

The WEO system is already installed by: **Komatsu, Palfinger, Volvo, Atlas Copco, Class, Fassi, producers of hydraulic grabs, etc.**

DATA SHEET

- Tests: WEO Plug-In hose fittings have been tested and approved by the Swedish Institute of Materials Testing and Research to SS-ISO 8032 – Half Omega Test, and have been burst tested to a minimum pressure of four times the working pressure. The fittings have also been tested and approved by TÜV, Germany.
- Material seal: Nitrile (NBR), other sealing materials on request.
- Temperature range: -30°C 100°C -22°F212°F
- Working Pressure, Safety Factor: WEO fitting sizes 1/4 inch through 3/4 inch have a maximum working pressure of 350 bar (5075 PSI). The 1-inch size has a maximum working pressure of 250 bar (3625 PSI). A minimum safety factor of 4:1 between burst pressure and working pressure applies to all sizes. Note: Working pressure may vary among sizes. Refer to the data for each product range.



ISTRUZIONI DI UTILIZZO

COLLEGAMENTO

Prima Fase:

Controllare che il fermo di montaggio in plastica sia inserito nella cava e che l'anello di sblocco (in plastica) si muova liberamente nel proprio alloggiamento;

Seconda Fase:

Inserire il raccordo maschio nella femmina per allargare i fermi di bloccaggio;

Terza Fase:

Spingere a fondo il raccordo maschio finché il fermo di montaggio non vada in battuta sulla femmina;

Quarta Fase:

L'o-ring compresso preme i ganci di blocco nella cava del raccordo maschio. A questo punto il raccordo è bloccato e non ha possibilità di scollegarsi.

- 1: Fermo di montaggio
- 2: Anello di sblocco
- 3: Fermo
- 4: Raccordo femmina
- 5: O-ring
- 6: Back up

SCOLLEGAMENTO

Prima Fase:

Rimuovere il fermo di montaggio dalla sua sede con un cacciavite;

Seconda Fase:

Spingere a fondo il maschio sino a portarlo in battuta;

Terza Fase:

Estrarre il maschio con decisione; all'interno del sistema l'anello di sblocco terrà aperti i fermi meccanici permettendo lo scollegamento.

- 1: Fermo di montaggio
- 2: Anello di sblocco
- 3: Fermi
- 4: Back up
- 5: Anello di sblocco.



CONNECTION

First stage:

Make sure the assembly stop is in place and the release ring runs freely in its groove;

Second stage:

The plug is pushed into the socket so that the locking hooks are pressed outwards;

Third stage:

Push the plug all the way in until the assembly stop touches the socket.

Fourth stage:

The O-ring presses the locking hooks inwards so that they grip the outer locking flange on the plug. The coupling is now locked and cannot be disconnected.

- 1: Assembly stop
- 2: Release ring
- 3: Locking hook
- 4: Socket
- 5: O-ring
- 6: Outer locking flange.

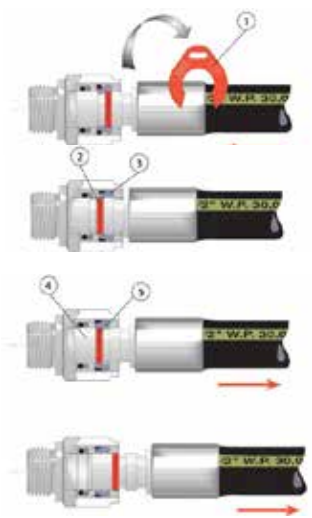

DISCONNECTION

First stage:

Using a screwdriver, remove the assembly stop;

Second stage:

Push the plug all the way in so that the release ring pushes the locking hooks aside;

Third stage:

Pull the plug out so that its outer flange connects with the release ring and draws it backwards, preventing the hooks from locking and allowing the plug to be fully withdrawn.

- 1: Assembly stop
- 2: Release ring
- 3: Locking hook
- 4: Outer flange
- 5: Release ring.

**Maschio Plug-In
Plug-In Male**



Tubo Hose		Maschio Male	Pr. es. WP	Ø	Maschio Plug-In Plug-In Male	Maschio Plug-In 90° Plug-In Male	Maschio Plug-In 45° Plug-In Male	
DN	inch.	inch.	Bar		Codice / Part. nr.	Codice / Part. nr.	Codice / Part. nr.	
6	1/4"	1/4"	6,9	350	10	147 100 404	147 140 404	147 120 404
6	1/4"	3/8"	10,1	350	13	147 100 604	147 140 604	147 120 604
10	3/8"	3/8"	10,1	350	13	147 100 606	147 140 606	147 120 606
13	1/2"	1/2"	13	350	16	147 100 808	147 140 808	147 120 808
19	3/4"	3/4"	20	350	23	147 101 212	147 141 212	147 121 212
25	1"	1"	26,2	250	30	147 101 616		

**Femmina Plug-In
Plug-In Female**



**Adattatore Plug-In
Plug-In Adaptor**

Tubo Hose		Femmina Female	Pr. es. WP	Ø	Femmina Plug-In Plug-In Female	Cartuccia Cartridge	Maschio Male	Adattatore Maschio Gas Femmina Plug-In Male BSPP Adaptor Plug-In Female	
DN	inch.	inch.	Bar		Codice / Part. nr.	inch.	inch.	Codice / Part. nr.	
6	1/4"	1/4"	6,9	350	10	148 170 404	1/4"	1/4"	148 300 404
10	3/8"	3/8"	10,1	350	13	148 170 606	3/8"	3/8"	148 300 606
13	1/2"	1/2"	10,1	350	13	148 170 808	1/2"	1/2"	148 300 808
19	3/4"	3/4"	13	350	16	148 171 212	3/4"	3/4"	148 301 212
25	1"	1"	20	350	23	148 171 616	1"	1"	148 301 616

**Giunto girevole Plug-In
Plug-In Swivel Joint**



Cartuccia Cartridge	Maschio Male	Pr. es. WP	Giunto Girevole Plug-In Plug-In Swivel Joint
inch.	inch.	Bar	Codice / Part. nr.
3/8"	3/8"	350	148 600 606
1/2"	1/2"	350	148 600 808
3/4"	3/4"	350	148 601 212



RACCORDI PER TUBO FLESSIBILE
FLEXIBLE HOSE FITTINGS

BOCCOLE E RACCORDI INTERLOCK
INTERLOCK FERRULES & FITTINGS



**Doppia Pelatura
Double Skive**



Tubo Hose		Tubo / Hose 4SH		Tubo / Hose R13/R15	
DN	inch.	Codice / Part. nr.	Codice / Part. nr.	Codice / Part. nr.	Codice / Part. nr.
19	3/4"	* 014 611 340	014 611 340	014 611 340	014 611 340
25	1"	* 014 611 100	014 611 100	014 611 100	014 611 100
32	1.1/4"	* 014 611 114	014 611 114	014 610 114	014 610 114
38	1.1/2"	* 014 611 112	014 611 112	014 610 112	014 610 112
50	2"	* 014 611 200	014 611 200	014 610 200	014 610 200

* Fornibile anche in Acciaio Inox/Also Stainless Steel available

**NELLA VERSIONE ZINCO-NICHEL
UTILIZZARE L'ACCOPIATA
BOCCOLE & RACCORDI**
In the Zinco-Nichel version using
ferrules & fittings coupled

PER FLANGE SPECIALI - FOR SPECIAL FLANGE

**Doppia Pelatura
Double Skive**



Tubo Hose		Tubo / Hose 4SH		Tubo / Hose R13/R15	
DN	inch.	Codice / Part. nr.	Codice / Part. nr.	Codice / Part. nr.	Codice / Part. nr.
19	3/4"	HV12	HV12	HV12	HV12
25	1"	HV16	HV16	HV16	HV16
32	1.1/4"	HV20	HV20	HVR20	HVR20

**NELLA VERSIONE ZINCO-NICHEL
UTILIZZARE L'ACCOPIATA
BOCCOLE & RACCORDI**
In the Zinco-Nichel version using
ferrules & fittings coupled



**Doppia Pelatura
Double Skive**



Tubo Hose		Filetto Thread		Femmina MDKOR MDKOR Female		Femmina MDKOR90 MDKOR90 Female		Femmina MDKOR45 MDKOR45 Female	
DN	inch.	inch.	Codice / Part. nr.	Codice / Part. nr.	Codice / Part. nr.	Codice / Part. nr.	Codice / Part. nr.	Codice / Part. nr.	Codice / Part. nr.
19	3/4"	G 3/4"-14	210 171 212	290 171 212	•	245 171 212			
19	3/4"	G 1"-11	• 210 171 216	• 290 171 216					
25	1"	G 1"-11	210 171 616	• 290 171 616	•	245 171 616			
25	1"	G 1.1/4"-11	• 210 171 620	• 290 171 620	•	245 171 620			
32	1.1/4"	G 1.1/4"-11	210 172 020	• 290 172 020	•	245 172 020			
38	1.1/2"	G 1.1/2"-11	210 172 424	• 290 172 424	•	245 172 424			
50	2"	G 2"-11	• 210 173 232	• 290 173 232	•	245 173 232			

NELLA VERSIONE ZINCO-NICHEL UTILIZZARE L'ACCOPIATA BOCCOLE & RACCORDI
In the Zinco-Nichel version using ferrules & fittings coupled

**Doppia Pelatura
Double Skive**



Tubo Hose		Filetto Thread		Maschio MAGR MAGR Male		Maschio NPTF MAGN MAGN NPTF Male	
DN	inch.	inch.	Codice / Part. nr.	Codice / Part. nr.	Codice / Part. nr.	Codice / Part. nr.	Codice / Part. nr.
19	3/4"	G 3/4"-14	200 171 212	19	3/4"	3/4"-14	• 200 181 212
19	3/4"	G 1"-11		19	3/4"	1"-11,5	• 200 181 216
25	1"	G 1"-11	• 200 171 616	25	1"	1"-11,5	• 200 181 616
25	1"	G 1.1/4"-11	• 200 171 620	25	1"	1.1/4"-11,5	
32	1.1/4"	G 1.1/4"-11	• 200 172 020	32	1.1/4"	1.1/4"-11,5	• 200 182 020
38	1.1/2"	G 1.1/2"-11	• 200 172 424	38	1.1/2"	1.1/2"-11,5	• 200 182 424
50	2"	G 2"-11	• 200 173 232	50	2"	2"-11,5	• 200 183 232

NELLA VERSIONE ZINCO-NICHEL UTILIZZARE L'ACCOPIATA BOCCOLE & RACCORDI
In the Zinco-Nichel version using ferrules & fittings coupled

• Fornibile in 7 gg lavorativi / Available in 7 working days



**Doppia Pelatura
Double Skive**



Tubo Hose		Filetto Thread	Femmina MDKOJ MDKOJ Female	Femmina MDKOJ90 MDKOJ90 Female	Femmina MDKOJ45 MDKOJ45 Female
DN	inch.	inch.	Codice / Part. nr.	Codice / Part. nr.	Codice / Part. nr.
19	3/4"	1.1/16"-12 UN	● 210 271 212	● 290 271 212	● 245 271 212
19	3/4"	1.5/16"-12 UN	● 210 271 216	● 290 271 216	
25	1"	1.5/16"-12 UN	● 210 271 616	● 290 271 616	● 245 271 616
25	1"	1.5/8"-12 UN	● 210 271 620		
32	1.1/4"	1.5/8"-12 UN	● 210 272 020	● 290 272 020	● 245 272 020
32	1.1/4"	1.7/8"-12 UN	● 210 272 024	● 290 272 024	● 245 272 024
38	1.1/2"	1.7/8"-12 UN	● 210 272 424	● 290 272 424	● 245 272 424
50	2"	2.1/2"-12 UN	● 210 273 232	● 290 273 232	● 245 273 232

NELLA VERSIONE ZINCO-NICHEL UTILIZZARE L'ACCOPIATA BOCCOLE & RACCORDI
In the Zinco-Nichel version using ferrules & fittings coupled

**Doppia Pelatura
Double Skive**



Tubo Hose		Filetto Thread	Maschio MAGJ MAGJ Male
DN	inch.	inch.	Codice / Part. nr.
19	3/4"	1.1/16"-12 UN	● 200 271 212
19	3/4"	1.5/16"-12 UN	● 200 271 216
25	1"	1.5/16"-12 UN	● 200 271 616
25	1"	1.5/8"-12 UN	● 200 271 620
32	1.1/4"	1.5/8"-12 UN	● 200 272 020
32	1.1/4"	1.7/8"-12 UN	● 200 272 024
38	1.1/2"	1.7/8"-12 UN	● 200 272 424
50	2"	2.1/2"-12 UN	● 200 273 232

NELLA VERSIONE ZINCO-NICHEL UTILIZZARE L'ACCOPIATA BOCCOLE & RACCORDI
In the Zinco-Nichel version using ferrules & fittings coupled



**Doppia Pelatura
Double Skive**



Tubo Hose		Filetto Thread	Femmina MORFS MORFS Female	Femmina MORFS90 MORFS90 Female	Femmina MORFS45 MORFS45 Female
DN	inch.	inch.	Codice / Part. nr.	Codice / Part. nr.	Codice / Part. nr.
19	3/4"	1.3/16" UN	● 210 611 219	● 290 611 219	● 245 611 219
19	3/4"	1.7/16" UN	● 210 611 223	● 290 611 223	● 245 611 223
25	1"	1.7/16" UN	● 210 611 623	● 290 611 623	● 245 611 623
32	1.1/4"	1.11/16" UN	● 210 612 027	● 290 612 027	● 245 612 027
38	1.1/2"	2" UN	● 210 612 432	● 290 612 432	● 245 612 432

NELLA VERSIONE ZINCO-NICHEL UTILIZZARE L'ACCOPIATA BOCCOLE & RACCORDI
In the Zinco-Nichel version using ferrules & fittings coupled

**Doppia Pelatura
Double Skive**



Tubo Hose		Filetto Thread	Maschio MORFS MORFS Male
DN	inch.	inch.	Codice / Part. nr.
19	3/4"	1.3/16" UN	● 200 611 219
19	3/4"	1.7/16" UN	● 200 611 223
25	1"	1.7/16" UN	● 200 611 623
32	1.1/4"	1.11/16" UN	● 200 612 027

NELLA VERSIONE ZINCO-NICHEL UTILIZZARE L'ACCOPIATA BOCCOLE & RACCORDI
In the Zinco-Nichel version using ferrules & fittings coupled



**Doppia Pelatura
Double Skive**



Tubo Hose		Filetto Thread		Femmina MDKOS MDKOS Female	Femmina MDKOS90 MDKOS90 Female	Femmina MDKOS45 MDKOS45 Female
DN	inch.	inch.	Ø	Codice / Part. nr.	Codice / Part. nr.	Codice / Part. nr.
19	3/4"	M 30x2	20S	210 912 303	290 912 303	245 912 303
19	3/4"	M 36x2	25S	210 912 363	290 912 363	245 912 363
25	1"	M 36x2	25S	210 916 363	290 916 363	245 916 363
25	1"	M 42x2	30S	210 916 423	290 916 423	245 916 423
32	1.1/4"	M 42x2	30S	210 920 423	290 920 423	245 920 423
32	1.1/4"	M 52x2	38S	210 920 523	290 920 523	245 920 523
38	1.1/2"	M 52x2	38S	210 924 523	290 924 523	245 924 523

NELLA VERSIONE ZINCO-NICHEL UTILIZZARE L'ACCOPIATA BOCCOLE & RACCORDI
In the Zinco-Nichel version using ferrules & fittings coupled

**Doppia Pelatura
Double Skive**



Tubo Hose		Filetto Thread		Maschio MCES MCES Male
DN	inch.	inch.	Ø	Codice / Part. nr.
19	3/4"	M 30x2	20S	200 912 303
19	3/4"	M 36x2	25S	200 912 363
25	1"	M 36x2	25S	200 916 363
25	1"	M 42x2	30S	200 916 423
32	1.1/4"	M 42x2	30S	200 920 423
32	1.1/4"	M 52x2	38S	200 920 523
38	1.1/2"	M 52x2	38S	200 924 523

NELLA VERSIONE ZINCO-NICHEL UTILIZZARE L'ACCOPIATA BOCCOLE & RACCORDI
In the Zinco-Nichel version using ferrules & fittings coupled



**Doppia Pelatura
Double Skive**



Tubo Hose		Flangia Ø Flange Ø		Flangia FL3 Diritta FL3 Straight Flange	Flangia FL3 90 FL3 90 Flange	Flangia FL3 45 FL3 45 Flange	
DN	inch.	inch.	mm	spess.	Codice / Part. nr.	Codice / Part. nr.	Codice / Part. nr.
19	3/4"	3/4"	38,1	6,7	211 931 212	299 931 212	249 931 212
19	3/4"	1"	44,5	8,0	211 931 216	299 931 216	249 931 216
25	1"	3/4"	38,1	6,7	211 931 612	299 931 612	249 931 612
25	1"	1"	44,5	8,0	211 931 616	299 931 616	249 931 616
25	1"	1.1/4"	50,8	8,0	211 931 620	299 931 620	249 931 620
32	1.1/4"	1.1/4"	50,8	8,0	211 932 020	299 932 020	249 932 020
32	1.1/4"	1.1/2"	60,3	8,0	211 932 024	299 932 024	249 932 024
38	1.1/2"	1.1/2"	60,3	8,0	211 932 424	299 932 424	249 932 424
38	1.1/2"	2"	71,4	9,5	211 932 432	299 932 432	249 932 432
50	2"	2"	71,4	9,5	211 933 232	299 933 232	249 933 232

NELLA VERSIONE ZINCO-NICHEL UTILIZZARE L'ACCOPIATA BOCCOLE & RACCORDI
In the Zinco-Nichel version using ferrules & fittings coupled

O-Ring	Ø	Codice / Part. nr.	O-Ring	Ø	Codice / Part. nr.
	3/4"	903 214 000		3/4"	993 214 000
	1"	903 219 000		1"	993 219 000
	1.1/4"	903 222 000		1.1/4"	993 222 000
	1.1/2"	903 225 000		1.1/2"	993 225 000
	2"	903 228 000		2"	993 228 000

BOCCOLE E RACCORDI INTERLOCK

INTERLOCK FERRULES & FITTINGS

RACCORDI FLANGIA SAE J518 - SERIE 6000



Doppia Pelatura
Double Skive

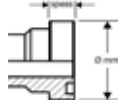

DN	Tubo Hose		Flangia Ø Flange Ø		spess.	Flangia FL6 Diritta	Flangia FL6 90	Flangia FL6 45
	inch.	inch.	mm	mm		FL6 Straight Flange	FL6 90 Flange	FL6 45 Flange
						Codice / Part. nr.	Codice / Part. nr.	Codice / Part. nr.
19	3/4"	3/4"	41,3	8,8	●	211 961 212	● 299 961 212	249 961 212
19	3/4"	1"	47,6	9,5	●	211 961 216	● 299 961 216	● 249 961 216
25	1"	3/4"	41,3	8,8	●	211 961 612	● 299 961 612	● 249 961 612
25	1"	1"	47,6	9,5		211 961 616	299 961 616	● 249 961 616
25	1"	1.1/4"	54,0	8,0	●	211 961 620	● 299 961 620	249 961 620
32	1.1/4"	1.1/4"	54,0	8,0		211 962 020	299 962 020	249 962 020
32	1.1/4"	1.1/2"	63,5	12,6		211 962 024	● 299 962 024	● 249 962 024
38	1.1/2"	1.1/2"	63,5	12,6		211 962 424	● 299 962 424	● 249 962 424
38	1.1/2"	2"	79,4	12,4	●	211 962 432	● 299 962 432	● 249 962 432
50	2"	2"	79,4	12,4		211 963 232	● 299 963 232	● 249 963 232

NELLA VERSIONE ZINCO-NICHEL UTILIZZARE L'ACCOPIATA BOCCOLE & RACCORDI
In the Zinco-Nichel version using ferrules & fittings coupled

O-Ring	Ø	Codice / Part. nr.	O-Ring	Ø	Codice / Part. nr.
	3/4"	903 214 000		3/4"	993 214 000
	1"	903 219 000		1"	993 219 000
	1.1/4"	903 222 000		1.1/4"	993 222 000
	1.1/2"	903 225 000		1.1/2"	993 225 000
	2"	903 228 000		2"	993 228 000

● Fornibile in 7 gg lavorativi / Available in 7 working days

BOCCOLE E RACCORDI INTERLOCK

INTERLOCK FERRULES & FITTINGS

RACCORDI FLANGIA - SERIE SUPERCAT



Doppia Pelatura
Double Skive

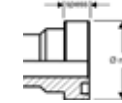

DN	Tubo Hose		Flangia Ø Flange Ø		spess.	Flangia FL9 Diritta	Flangia FL9 90	Flangia FL9 45
	inch.	inch.	mm	mm		FL9 Straight Flange	FL9 90 Flange	FL9 45 Flange
						Codice / Part. nr.	Codice / Part. nr.	Codice / Part. nr.
19	3/4"	3/4"	41,3	14,2		211 991 212	299 991 212	● 249 991 212
19	3/4"	1"	47,6	14,2	●	211 991 216	● 299 991 216	● 249 991 216
25	1"	1"	47,6	14,2		211 991 616	299 991 616	249 991 616
25	1"	1.1/4"	54,0	14,2		211 991 620	● 299 991 620	● 249 991 620
32	1.1/4"	1.1/4"	54,0	14,2	●	211 992 020	299 992 020	● 249 992 020
32	1.1/4"	1.1/2"	63,5	14,2	●	211 992 024	● 299 992 024	● 249 992 024
38	1.1/2"	1.1/2"	63,5	14,2		211 992 424	299 992 424	249 992 424

NELLA VERSIONE ZINCO-NICHEL UTILIZZARE L'ACCOPIATA BOCCOLE & RACCORDI
In the Zinco-Nichel version using ferrules & fittings coupled

O-Ring	Ø	Codice / Part. nr.	O-Ring	Ø	Codice / Part. nr.
	3/4"	903 214 000		3/4"	993 214 000
	1"	903 219 000		1"	993 219 000
	1.1/4"	903 222 000		1.1/4"	993 222 000
	1.1/2"	903 225 000		1.1/2"	993 225 000
	2"	903 228 000		2"	993 228 000

● Fornibile in 7 gg lavorativi / Available in 7 working days



COLLO LUNGO - LONG DROP

Doppia Pelatura
Double Skive



DN	Tubo Hose		Flangia Ø Flange Ø		H +,-2,5	Flangia FL6 90° speciale Special FL6 90° Flange	Codice / Part. nr.
	inch.	inch.	mm	spess.			
19	3/4"	3/4"	41,3	8,8	80	● HV12SFH6-90S12-SL80	
19	3/4"	3/4"	41,3	8,8	100	● HV12SFH6-90S12-SL100	
19	3/4"	3/4"	41,3	8,8	120	● HV12SFH6-90S12-SL120	
19	3/4"	3/4"	41,3	8,8	135	● HV12SFH6-90S12-SL135	
25	1"	1"	47,6	9,5	100	● HV16SFH6-90S16-SL100	
25	1"	1"	47,6	9,5	110	● HV16SFH6-90S16-SL110	
25	1"	1"	47,6	9,5	120	● HV16SFH6-90S16-SL120	
25	1"	1"	47,6	9,5	130	● HV16SFH6-90S16-SL130	
32	1.1/4"	1.1/4"	54,0	8,0	100	● HV20SFH6-90S20-SL100	
32	1.1/4"	1.1/4"	54,0	8,0	150	● HV20SFH6-90S20-SL150	
32	1.1/4"	1.1/4"	54,0	8,0	170	● HV20SFH6-90S20-SL170	

NELLA VERSIONE ZINCO-NICHEL UTILIZZARE L'ACCOPIATA BOCCOLE & RACCORDI
In the Zinco-Nichel version using ferrules & fittings coupled



CURVE SPECIALI - SPECIAL ELBOW

Doppia Pelatura
Double Skive

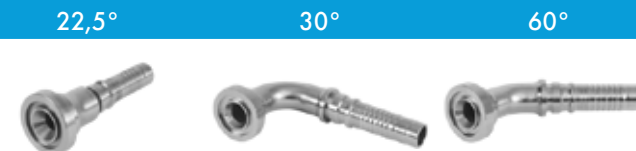

DN	Tubo Hose		Flangia Ø Flange Ø		Flangia FL6 22,5° FL6 22,5° Flange	Flangia FL6 30° FL6 30° Flange	Flangia FL6 60° FL6 60° Flange
	inch.	inch.	mm	spess.			
19	3/4"	3/4"	41,3	8,8	● HV12SFH6-22,5S12	● HV12SFH6-30S12	● HV12SFH6-60S12
19	3/4"	1"	47,6	9,5			● HV16SFH6-60S12
25	1"	1"	47,6	9,5	● HV16SFH6-22,5S16	● HV16SFH6-30S16	● HV16SFH6-60S16
32	1.1/4"	1.1/4"	54,0	8,0	● HV20SFH6-22,5S20	● HV20SFH6-30S20	● HV20SFH6-60S20

Doppia Pelatura
Double Skive



DN	Tubo Hose		Flangia Ø Flange Ø		Flangia FL6 67,5° FL6 67,5° Flange	Flangia FL6 100° FL6 100° Flange	Flangia FL6 110° FL6 110° Flange
	inch.	inch.	mm	spess.			
19	3/4"	3/4"	41,3	8,8	● HV12SFH6-67,5S12	● HV12SFH6-100S12	● HV12SFH6-110S12
25	1"	1"	47,6	9,5	● HV16SFH6-67,5S16	● HV16SFH6-100S16	● HV16SFH6-110S16
32	1.1/4"	1.1/4"	54,0	8,0	● HV20SFH6-67,5S20	● HV20SFH6-100S20	● HV20SFH6-110S20

Doppia Pelatura
Double Skive



DN	Tubo Hose		Flangia Ø Flange Ø		Flangia FL6 130° FL6 130° Flange	Flangia FL6 135° FL6 135° Flange
	inch.	inch.	mm	spess.		
19	3/4"	3/4"	41,3	8,8	● HV12SFH6-130S12	
25	1"	1"	47,6	9,5	● HV16SFH6-130S16	● HV16SFH6-135S16
32	1.1/4"	1.1/4"	54,0	8,0	● HV20SFH6-130S20	

NELLA VERSIONE ZINCO-NICHEL UTILIZZARE L'ACCOPIATA BOCCOLE & RACCORDI
In the Zinco-Nichel version using ferrules & fittings coupled



RACCORDI PER TUBO FLESSIBILE
FLEXIBLE HOSE FITTINGS

PROGRAMMA ALTA PRESSIONE 700 bar
700 bar HIGH PRESSURE PROGRAM

BOCCOLE A PRESSARE



700 bar



Tubo Hose		Tubo / Hose TP10HS		Tubo / Hose TP10HS/NC	
DN	inch.	Codice / Part. nr.		Codice / Part. nr.	
4	1/8"			●	XJ02HL
6	1/4"	XJ04HS		●	XJ04HL
10	3/8"	XJ06HS			

TAMPONE DI CONTROLLO



Tubo/ Hose Lato A		Tubo/ Hose Lato B		Tampone di Controllo Serie XJ XJ Series Test Mandrel	
DN	inch.	DN	inch.	Codice / Part. nr.	
6	1/4"	10	3/8"	●	PD-TP10HS



Pressatura Perfetta

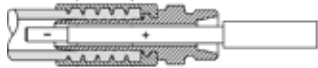

Pressatura Non Corretta

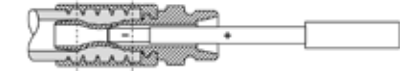

Pressatura Completamente Errata

RACCORDI BSP SEDE 60°



700 bar



Tubo Hose		Filetto Thread		Femmina DKR DKR Female		Maschio AGR AGR Male		Maschio AG Faccia Piana Flat Face AG Male	
DN	inch.	inch.		Codice / Part. nr.		Codice / Part. nr.		Codice / Part. nr.	
4	1/8"	G 1/4"-19						●	XJ04BMR02
6	1/4"	G 1/4"-19		XJ04BF04		●	XJ04BM04	●	XJ04BMR04
10	3/8"	G 3/8"-19		XJ06BF06					

RACCORDI NPTF SEDE 60°

700 bar



Tubo Hose		Filetto Thread		Maschio NPTF AGN AGN NPTF Male	
DN	inch.	inch.		Codice / Part. nr.	
4	1/8"	1/4"-18		●	XJ04NM02
4	1/8"	3/8"-18		●	XJ06NM02
6	1/4"	1/4"-18		●	XJ04NM04
6	1/4"	3/8"-18		●	XJ06NM04
10	3/8"	3/8"-18		●	XJ06NM06

PROGRAMMA ALTA PRESSIONE 700 bar
700 bar HIGH PRESSURE PROGRAM

RACCORDI JIC SEDE 74°



700 bar



Tubo Hose		Filetto Thread		Femmina DKJ DKJ Female
DN	inch.	inch.		Codice / Part. nr.
6	1/4"	1/2"-20 UNF	●	XJ08JF04
6	1/4"	9/16"-18 UNF	●	XJ09JF04

RACCORDI METRICI FACCIA PIANA

700 bar



Tubo Hose		Filetto Thread	Maschio Metrico Sede Piana Flat Face Metric Male	
DN	inch.	mm	Codice / Part. nr.	
6	1/4"	M 12x1,5	XJ12MMW04	

● Fornibile in 7 gg lavorativi / Available in 7 working days

PROGRAMMA ALTA PRESSIONE 700 bar
700 bar HIGH PRESSURE PROGRAM

RACCORDI METRICI SEDE 24° DKL



SERIE LEGGERA - LIGHT SERIES

700 bar

SERIE LEGGERA
Light Series



Tubo Hose		Filetto Thread		Femmina DKL DKL Female
DN	inch.	mm.	Ø	Codice / Part. nr.
4	1/8"	M 14x1,5	8L	● XJMSF0802
6	1/4"	M 14x1,5	8L	XJMSF0804

RACCORDI METRICI SEDE 24° DKS

700 bar

SERIE LEGGERA
Light Series



Tubo Hose		Filetto Thread		Femmina DKS DKS Female
DN	inch.	mm.	Ø	Codice / Part. nr.
4	1/8"	M 16x1,5	8S	● XJMSS0802
6	1/4"	M 16x1,5	8S	XJMSS0804
6	1/4"	M 18x1,5	10S	XJMSS1004

RACCORDI METRICI SEDE 24° DKOS CON O-RING

700 bar

SERIE PESANTE
Heavy Series



Tubo Hose		Filetto Thread		Femmina DKS DKS Female
DN	inch.	mm.	Ø	Codice / Part. nr.
6	1/4"	M 18x1,5	10S	● XJMSO1004

● Fornibile in 7 gg lavorativi / Available in 7 working days



RACCORDI PER TUBO FLESSIBILE
FLEXIBLE HOSE FITTINGS

BOCCOLE & RACCORDI RECUPERABILI
REUSABLE FERRULES & FITTINGS



Tubo Hose		Tubo / Hose 1SN	Tubo / Hose 2SN
DN	inch.	Codice / Part. nr.	Codice / Part. nr.
5	3/16"	014 620 110	
6	1/4"	014 620 111	014 620 211
8	5/16"	014 620 112	014 620 212
10	3/8"	014 620 113	014 620 213
13	1/2"	014 620 114	014 620 214
16	5/8"	● 014 620 115	● 014 620 215
19	3/4"	● 014 620 116	014 620 216
25	1"	● 014 620 117	014 620 217
32	1.1/4"	● 014 620 118	
38	1.1/2"	● 014 620 119	



Tubo Hose		Tubo / Hose R7	Tubo / Hose TP1
DN	inch.	Codice / Part. nr.	Codice / Part. nr.
4	5/32"- 4x8	014 620 028	
5	3/16"	014 620 029	● 014 620 040
6	1/4"	014 620 031	● 014 620 041
8	5/16"	014 620 032	● 014 620 042
10	3/8"	014 620 033	● 014 620 043
13	1/2"	● 014 620 034	● 014 620 044

● Fornibile in 7 gg lavorativi / Available in 7 working days



Tubo Hose		Filetto Thread	Femmina DKR DKR Female	Femmina DKR90 DKR90 Female	Femmina DKR45 DKR45 Female
DN	inch.	inch.	Codice / Part. nr.	Codice / Part. nr.	Codice / Part. nr.
4	5/32"- 4x8	G 1/8"-28	210 120 102	290 120 102	● 245 120 102
4	5/32"- 4x8	G 1/4"-19	● 210 120 104	● 290 120 104	
5	3/16"	G 1/8"-28	210 120 302	● 290 120 302	● 245 120 302
5	3/16"	G 1/4"-19	210 120 304	● 290 120 304	● 245 120 304
6	1/4"	G 1/4"-19	210 120 404	290 120 404	● 245 120 404
6	1/4"	G 3/8"-19	210 120 406	● 290 120 406	
8	5/16"	G 1/4"-19	210 120 504	● 290 120 504	
8	5/16"	G 3/8"-19	210 120 506	● 290 120 506	● 245 120 506
10	3/8"	G 3/8"-19	210 120 606	290 120 606	● 245 120 606
10	3/8"	G 1/2"-14	210 120 608	● 290 120 608	● 245 120 608
13	1/2"	G 1/2"-14	210 120 808	290 120 808	● 245 120 808
13	1/2"	G 5/8"-14	● 210 120 810		
16	5/8"	G 5/8"-14	● 210 121 010	● 290 121 010	● 245 121 010
16	5/8"	G 3/4"-14	● 210 121 012	● 290 121 012	● 245 121 012
19	3/4"	G 3/4"-14	210 121 212	● 290 121 212	● 245 121 212
25	1"	G 1"-11	210 121 616	● 290 121 616	● 245 121 616
32	1.1/4"	G 1.1/4"-11	● 210 122 020	● 290 122 020	
38	1.1/2"	G 1.1/4"-11	● 210 122 424	● 290 122 424	

● Fornibile in 7 gg lavorativi / Available in 7 working days

BOCCOLE & RACCORDI RECUPERABILI REUSABLE FERRULES & FITTINGS

RACCORDI BSP SEDE 60°

HSR®



Tubo Hose		Filetto Thread	Maschio cilindrico AGR AGR BSP Male	Maschio Conico AGR K AGR K BSPT Male
DN	inch.	inch.	Codice / Part. nr.	Codice / Part. nr.
4	5/32"	G 1/8"-28	• 200 120 102	
5	3/16"	G 1/8"-28	• 200 120 302	
5	3/16"	G 1/4"-19	• 200 120 304	
6	1/4"	G 1/4"-19	• 200 120 404	• 200 130 404
6	1/4"	G 3/8"-19	• 200 120 406	
8	5/16"	G 3/8"-19	• 200 120 506	• 200 130 506
6	3/8"	G 3/8"-19	• 200 120 606	• 200 130 606
6	3/8"	G 1/2"-14	• 200 120 608	• 200 130 608
13	1/2"	G 1/2"-14	• 200 120 808	• 200 130 808
13	1/2"	G 3/4"-14	• 200 120 812	
16	5/8"	G 5/8"-14	• 200 121 010	
16	5/8"	G 3/4"-14	• 200 121 012	• 200 131 012
19	3/4"	G 3/4"-14	• 200 121 212	• 200 131 212
19	3/4"	G 1"-11	• 200 121 216	
25	1"	G 1.1/4"-11	• 200 121 616	• 200 131 616
32	1.1/4"	G 1.1/4"-11		• 200 132 020
38	1.1/2"	G 1.1/4"-11		• 200 132 424



Tubo Hose		Filetto Thread	Maschio NPTF AGN AGN NPTF Male
DN	inch.	inch.	Codice / Part. nr.
4	5/32"- 4x8	G 1/8"-28	• 200 150 102
5	3/16"	G 1/8"-28	• 200 150 302
5	3/16"	G 1/4"-19	• 200 150 304
6	1/4"	G 1/4"-19	• 200 150 404
6	1/4"	G 3/8"-19	• 200 150 406
8	5/16"	G 3/8"-19	• 200 150 506
6	3/8"	G 3/8"-19	• 200 150 606

• Fornibile in 7 gg lavorativi / Available in 7 working days

BOCCOLE & RACCORDI RECUPERABILI REUSABLE FERRULES & FITTINGS

RACCORDI JIC SEDE 74°

HSR®



Tubo Hose		Filetto Thread	Femmina DKJ DKJ Female	Femmina DKJ90 DKJ90 Female	Femmina DKJ45 DKJ45 Female
DN	inch.	inch.	Codice / Part. nr.	Codice / Part. nr.	Codice / Part. nr.
5	3/16"	7/16"-20 UNF	• 210 220 304	• 290 220 304	• 245 220 304
5	3/16"	1/2"-20 UNF	• 210 220 305	• 290 220 305	
6	1/4"	7/16"-20 UNF	• 210 220 404	• 290 220 404	• 245 220 404
6	1/4"	1/2"-20 UNF	• 210 220 405	• 290 220 405	• 245 220 405
6	1/4"	9/16"-19 UNF	• 210 220 406	• 290 220 406	• 245 220 406
8	5/16"	9/16"-19 UNF	• 210 220 506	• 290 220 506	• 245 220 506
10	3/8"	9/16"-18 UNF	• 210 220 606	• 290 220 606	
10	3/8"	3/4"-16 UNF	• 210 220 608	• 290 220 608	• 245 220 608
10	3/8"	7/8"-14 UNF	• 210 220 610		
13	1/2"	3/4"-16 UNF	• 210 220 808	• 290 220 808	• 245 220 808
13	1/2"	7/8"-14 UNF	• 210 220 810	• 290 220 810	• 245 220 810
16	5/8"	7/8"-14 UNF	• 210 221 010		
16	5/8"	1.1/16"-12 UN	• 210 221 012	• 290 221 012	
19	3/4"	1.1/16"-12 UN	• 210 221 212	• 290 221 212	• 245 221 212
25	1"	1.5/16"-12 UN	• 210 221 616	• 290 221 616	• 245 221 616



Tubo Hose		Filetto Thread	Maschio AGJ AGJ Male
DN	inch.	inch.	Codice / Part. nr.
6	1/4"	1/2"-20 UNF	• 200 220 405
8	5/16"	9/16"-19 UNF	• 200 220 506
10	3/8"	3/4"-16 UNF	• 200 220 608

• Fornibile in 7 gg lavorativi / Available in 7 working days



Conicità a 60°
60° Cone



Tubo Hose		Filetto Thread	Femmina Metrica Metric Female		Femmina Metr. 90° Metric 90° Female	Femmina Metr. 45° Metric 45° Female		
DN	inch.	mm	Codice / Part. nr.		Codice / Part. nr.	Codice / Part. nr.		
5	3/16"	M 10x1	●	210 323 100	●	290 323 100	●	245 323 100
6	1/4"	M 14x1,5	●	210 324 142	●	290 324 142		
6	1/4"	M 16x1,5	●	210 324 162	●	290 324 162		
8	5/16"	M 14x1,5	●	210 325 142	●	290 325 142		
8	5/16"	M 16x1,5	●	210 325 162	●	290 325 162	●	245 325 162
8	5/16"	M 18x1,5	●	210 325 182				
10	3/8"	M 16x1,5	●	210 326 162	●	290 326 162	●	245 326 162
10	3/8"	M 18x1,5	●	210 326 182	●	290 326 182	●	245 326 182
10	3/8"	M 22x1,5	●	210 326 222	●	290 326 222		
13	1/2"	M 18x1,5	●	210 328 182	●	290 328 182		
13	1/2"	M 20x1,5	●	210 328 202	●	290 328 202		
13	1/2"	M 22x1,5	●	210 328 222	●	290 328 222	●	245 328 222
16	5/8"	M 26x1,5	●	210 320 262	●	290 320 262		
19	3/4"	M 26x1,5	●	210 322 262	●	290 322 262		

Conicità a 60°
60° Cone



Tubo Hose		Filetto Thread	Maschio Metrico Metric Male	
DN	inch.	inch.	Codice / Part. nr.	
5	3/16"	M 10x1	●	200 323 100
8	5/16"	M 16x1,5	●	200 325 162
10	3/8"	M 16x1,5	●	200 326 162
10	3/8"	M 18x1,5	●	200 326 182
13	1/2"	M 22x1,5	●	200 328 222
16	5/8"	M 26x1,5	●	200 320 262

● Fornibile in 7 gg lavorativi / Available in 7 working days



SERIE LEGGERA
Light Series



Tubo Hose		Filetto Thread	Maschio CEL CEL Male	
DN	inch.	mm.	Ø	Codice / Part. nr.
6	1/4"	M 14x1,5	8L ●	200 424 142
8	5/16"	M 16x1,5	10L ●	200 425 162
10	3/8"	M 18x1,5	12L ●	200 426 182
13	1/2"	M 22x1,5	15L ●	200 428 222

SERIE PESANTE
Heavy Series



Tubo Hose		Filetto Thread	Maschio CES CES Male	
DN	inch.	mm.	Ø	Codice / Part. nr.
6	1/4"	M 18x1,5	10S ●	200 524 182
10	3/8"	M 22x1,5	14S ●	200 526 222
13	1/2"	M 24x1,5	16S ●	200 528 242

● Fornibile in 7 gg lavorativi / Available in 7 working days



DN	Tubo Hose		Ø Codolo Pipe Ø	Estremità Tubolare Standpipe		Estremità Tubolare 90° Standpipe		Estremità Tubolare 45° Standpipe	
	inch.	mm		Codice / Part. nr.	Codice / Part. nr.	Codice / Part. nr.	Codice / Part. nr.		
4	5/32"	4x8	04LL	●	222 800 104	●	222 890 104		
4	5/32"	4x8	06L	●	222 800 106	●	222 890 106	●	222 840 106
4	5/32"		08L/S	●	222 800 108				
5	3/16"		04LL	●	222 800 304	●	222 890 304		
5	3/16"		06L	●	222 800 306	●	222 890 306	●	222 840 306
5	3/16"		08S	●	222 800 308	●	222 890 308		
6	1/4"		06L	●	222 800 406	●	222 890 406	●	222 840 406
6	1/4"		08L/S	●	222 800 408	●	222 890 408	●	222 840 408
6	1/4"		10S	●	222 800 410	●	222 890 410	●	222 840 410
6	1/4"		12S	●	222 800 412	●	222 890 412		
8	5/16"		08L	●	222 800 508	●	222 890 508		
8	5/16"		10L	●	222 800 510	●	222 890 510	●	222 840 510
8	5/16"		12S	●	222 800 512	●	222 890 512	●	222 840 512
10	3/8"		10L	●	222 800 610	●	222 890 610		
10	3/8"		12L	●	222 800 612	●	222 890 612	●	222 840 612
10	3/8"		14S	●	222 800 614	●	222 890 614	●	222 840 614
10	3/8"		15L	●	222 800 615	●	222 890 615		
13	1/2"		15L	●	222 800 815	●	222 890 815	●	222 840 815
13	1/2"		16S	●	222 800 816	●	222 890 816	●	222 840 816
13	1/2"		18L	●	222 800 818	●	222 890 818		
16	5/8"		18L	●	222 801 018	●	222 891 018	●	222 841 018
16	5/8"		20S	●	222 801 020	●	222 891 020		
19	3/4"		20S	●	222 801 220	●	222 891 220		
19	3/4"		22L	●	222 801 222	●	222 891 222		
19	3/4"		25S	●	222 801 225	●	222 891 225		
25	1"		28L	●	222 801 628	●	222 891 628		
25	1"		30S	●	222 801 630				

● Fornibile in 7 gg lavorativi / Available in 7 working days



**Occhio per vite Gas
BSP Bolt Banjo**



**Occhio per vite Metrica
Metric Bolt Banjo**



DN	Tubo Hose		Ø Occhio Banjo Ø	Occhio BSP RNR		Occhio Metrico RNM				
	inch.	mm		RNR BSP Banjo	RNR Metric Banjo	RNM Metric Banjo	RNM Metric Banjo			
inch.	mm	Inch.	Codice / Part. nr.	Codice / Part. nr.	Codice / Part. nr.	Codice / Part. nr.				
4	5/32"	4x8	G 1/8"	●	221 700 102	4	1/8"	M 10	●	221 800 210
5	3/16"		G 1/8"	●	221 700 302	5	3/16"	M 10	●	221 800 310
5	3/16"		G 1/4"	●	221 700 304	6	1/4"	M 10	●	221 800 410
6	1/4"		G 1/8"	●	221 700 402	6	1/4"	M 12	●	221 800 412
6	1/4"		G 1/4"	●	221 700 404	6	1/4"	M 14	●	221 800 414
6	1/4"		G 3/8"	●	221 700 406	8	5/16"	M 16	●	221 800 516
8	5/16"		G 3/8"	●	221 700 506	8	5/16"	M 18	●	221 800 518
10	3/8"		G 3/8"	●	221 700 606	10	3/8"	M 18	●	221 800 618
10	3/8"		G 1/2"	●	221 700 608	10	3/8"	M 20	●	221 800 620
13	1/2"		G 1/2"	●	221 700 808	13	1/2"	M 18	●	221 800 818
16	5/8"		G 3/4"	●	221 701 012					
19	3/4"		G 3/4"	●	221 701 212					

● Fornibile in 7 gg lavorativi / Available in 7 working days



RACCORDI PER TUBO FLESSIBILE
FLEXIBLE HOSE FITTINGS

BOCCOLE & RACCORDI BASSA PRESSIONE
LOW PRESSURE FERRULES & FITTINGS

BOCCOLE & RACCORDI BASSA PRESSIONE

LOW PRESSURE FERRULES & FITTINGS

BOCCOLE A PRESSARE



Alluminio
Aluminium



Acciaio Leggero
Light Steel



Ø Interno ID Ø	Ø Esterno ED Ø	Boccola Alluminio Aluminium Ferrule	Ø Interno ID Ø	Ø Esterno ED Ø	Boccola Acciaio Steel Ferrule	Manicotto Acciaio Steel Sleeve
mm	mm	Codice / Part. nr.	mm	mm	Codice / Part. nr.	Codice / Part. nr.
8	10	014 000 810	17	20	● 014 501 720	014 601 720
9	11	014 000 911	19	22	● 014 501 922	014 601 922
10	12	014 001 012	21	24	● 014 502 124	014 602 124
11	13	014 001 113	22	25	● 014 502 225	014 602 225
12	14	014 001 214	24	27	● 014 502 427	014 602 427
13	15	014 001 315	27	30	● 014 502 730	014 602 730
14	16	014 001 416	29	32	● 014 502 932	014 602 932
15	17	014 001 517	32	35	● 014 503 235	014 603 235
16	18	014 001 618	35	38	● 014 503 538	014 603 538
17	19	014 001 719	37	40	● 014 503 740	014 603 740
18	20	014 001 820	39	42	● 014 503 942	014 603 942
20	22	014 002 022	42	45	● 014 504 245	014 604 245
22	24	014 002 224	46	50	● 014 504 650	014 604 650
23	25	014 002 325	48	52	● 014 504 852	014 604 852
24	26	014 002 426	51	55	● 014 505 155	014 605 155
25	27	014 002 527	56	60	● 014 505 660	014 605 660
26	28	014 002 628	60	65	● 014 506 065	014 606 065
28	30	014 002 830	65	70	● 014 506 570	014 606 570
29	31	014 002 931	70	75	● 014 507 075	014 607 075
30	32	014 003 032	76	82	● 014 507 682	014 607 682
32	34	014 003 234	80	85	● 014 508 085	014 608 085
36	38	014 003 638	85	90	● 014 508 590	014 608 590
38	40	014 003 840	90	95	● 014 509 095	014 609 095
			95	100	● 014 595 100	014 695 100
			100	105	● 014 100 105	018 100 105

● Fornibile in 7 gg lavorativi / Available in 7 working days

BOCCOLE & RACCORDI BASSA PRESSIONE

LOW PRESSURE FERRULES & FITTINGS

RACCORDI BSP SEDE 60°



Tubo Hose	Filetto Thread	Femmina DKR DKR Female	Femmina DKR90 DKR90 Female	Maschio AGR P AGR P Male	Femmina DKR P DKR P BSPP Female
DN	inch.	inch.	Codice / Part. nr.	Codice / Part. nr.	Codice / Part. nr.
6	1/4"	G 1/4"-19	● 210 190 404	● 290 190 404	● 200 190 404
8	5/16"	G 1/4"-19	● 210 190 504	● 290 190 504	● 200 190 504
8	5/16"	G 3/8"-19	● 210 190 506	● 290 190 506	● 200 190 506
10	3/8"	G 1/4"-19			● 200 190 604
10	3/8"	G 3/8"-19	● 210 190 606	● 290 190 606	● 200 190 606
10	3/8"	G 1/2"-14	● 210 190 608	● 290 190 608	● 200 190 608
13	1/2"	G 3/8"-19	● 210 190 806	● 290 190 806	● 200 190 806
13	1/2"	G 1/2"-14	● 210 190 808	● 290 190 808	● 200 190 808
16	5/8"	G 3/8"-19			● 200 191 006
16	5/8"	G 1/2"-14	● 210 191 008	● 290 191 008	● 200 191 008
16	5/8"	G 3/4"-14	● 210 191 012	● 290 191 012	● 200 191 012
19	3/4"	G 1/2"-14	● 210 191 208	● 290 191 208	● 200 191 208
19	3/4"	G 3/4"-14	● 210 191 212	● 290 191 212	● 200 191 212
19	3/4"	G 1"-11	● 210 191 216	● 290 191 216	● 200 191 216
25	1"	G 3/4"-14		● 290 191 612	● 200 191 612
25	1"	G 1"-11	● 210 191 616	● 290 191 616	● 200 191 616
32	1.1/4"	G 1"-11			● 200 192 016
32	1.1/4"	G 1.1/4"-11	● 210 192 020	● 290 192 020	● 200 192 020
32	1.1/4"	G 1.1/2"-11	● 210 192 024		
38	1.1/2"	G 1.1/2"-11	● 210 192 424	● 290 192 424	● 200 192 424
50	2"	G 2"-11	● 210 193 232	● 290 193 232	● 200 193 232
65	2.1/2"	G 2.1/2"-11	● 210 194 040		● 200 194 040
75	3"	G 3"-11	● 210 194 848		● 200 194 848

● Fornibile in 7 gg lavorativi / Available in 7 working days



Conicità a 60°
60° Cone



Tubo Hose		Filetto Thread	Femmina Metrica Metric Female	Femmina Metr. 90° Metric 90° Female	Femmina Metr. 45° Metric 45° Female
DN	inch.	mm	Codice / Part. nr.	Codice / Part. nr.	Codice / Part. nr.
6	1/4"	M 10x1	● 219 304 100		
6	1/4"	M 12x1,5			● 209 304 122
6	1/4"	M 14x1,5	● 219 304 142	● 299 304 142	● 209 304 142
8	5/16"	M 14x1,5	● 219 305 142		● 209 305 142
8	5/16"	M 16x1,5	● 219 305 162	● 299 305 162	
10	3/8"	M 14x1,5			● 209 306 142
10	3/8"	M 16x1,5			● 209 306 162
10	3/8"	M 18x1,5	● 219 306 182	● 299 306 182	● 209 306 182
13	1/2"	M 18x1,5	● 219 308 182	● 299 308 182	● 209 308 182
13	1/2"	M 22x1,5			● 209 308 222
16	5/8"	M 18x1,5			● 209 310 182
16	5/8"	M 22x1,5			● 209 310 222
19	3/4"	M 18x1,5			● 209 312 182
19	3/4"	M 22x1,5			● 209 312 222
19	3/4"	M 26x1,5			● 209 312 262

● Fornibile in 7 gg lavorativi / Available in 7 working days



Occhio per vite Gas
BSP Bolt Banjo



Occhio per vite Metrica
Metric Bolt Banjo



Tubo Hose		Ø Occhio Banjo Ø	Occhio BSP RNR RNR BSP Banjo	Tubo Hose	Ø Occhio Banjo Ø	Occhio Metrico RNM RNM Metric Banjo	
DN	inch.	Inch.	Codice / Part. nr.	DN	inch.	mm	Codice / Part. nr.
6	1/4"	G 1/4"	● 201 790 404	6	1/4"	M 8	● 201 890 408
8	5/16"	G 1/4"	● 201 790 504	6	1/4"	M 10	● 201 890 410
8	5/16"	G 3/8"	● 201 790 506	6	1/4"	M 12	● 201 890 412
10	3/8"	G 1/4"	● 201 790 604	6	1/4"	M 14	● 201 890 414
10	3/8"	G 3/8"	● 201 790 606	8	5/16"	M 10	● 201 890 510
10	3/8"	G 1/2"	● 201 790 608	8	5/16"	M 12	● 201 890 512
13	1/2"	G 3/8"	● 201 790 806	8	5/16"	M 14	● 201 890 514
13	1/2"	G 1/2"	● 201 790 808	10	3/8"	M 14	● 201 890 614
16	5/8"	G 1/2"	● 201 791 008	10	3/8"	M 16	● 201 890 616
16	5/8"	G 3/4"	● 201 791 012	10	3/8"	M 18	● 201 890 618
19	3/4"	G 1/2"	● 201 791 208	13	1/2"	M 18	● 201 890 818
19	3/4"	G 3/4"	● 201 791 212	16	5/8"	M 22	● 201 891 022
25	1"	G 3/4"	● 201 791 612	19	3/4"	M 18	● 201 891 218
25	1"	G 1"	● 201 791 616	19	3/4"	M 22	● 201 891 222

● Fornibile in 7 gg lavorativi / Available in 7 working days



ADATTATORI DI COLLEGAMENTO
CONNECTING ADAPTORS

ADATTATORI BSP/BSPT/NPT
BSP/BSPT/NPT ADAPTORS



BSP / BSPT



Filetto G1 G1 Thread	Filetto G2 G2 Thread		Nipplo M/M Gas M/M BSP Nipple		Nipplo M.Gas/M.conico M.BSP/M.BSPT Nipple		Nipplo M/M conico M/M BSPT Nipple
Inch	Inch		Codice / Part. nr.		Codice / Part. nr.		Codice / Part. nr.
G 1/8"-28	G 1/8"-28	*	300 000 202	●*	302 000 202	●*	301 000 202
G 1/4"-19	G 1/4"-19	*	300 000 404	*	302 000 404	*	301 000 404
G 3/8"-19	G 3/8"-19	*	300 000 606	*	302 000 606	*	301 000 606
G 1/2"-14	G 1/2"-14	*	300 000 808	*	302 000 808	*	301 000 808
G 5/8"-14	G 5/8"-14		300 001 010	●	302 001 010		
G 3/4"-14	G 3/4"-14	*	300 001 212	*	302 001 212	*	301 001 212
G 1"-11	G 1"-11	*	300 001 616	*	302 001 616	*	301 001 616
G 1.1/4"-11	G 1.1/4"-11	*	300 002 020	*	302 002 020	●*	301 002 020
G 1.1/2"-11	G 1.1/2"-11	*	300 002 424	●*	302 002 424	●*	301 002 424
G 2"-11	G 2"-11	*	300 003 232	●*	302 003 232	●*	301 003 232
G 2.1/2"-11	G 2.1/2"-11	●*	300 004 040	●*	302 004 040	●*	301 004 040
G 3"-11	G 3"-11	●	300 004 848	●	302 004 848		

BSP / BSPT

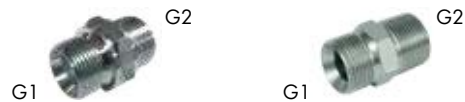

Filetto G1 G1 Thread	Filetto G2 G2 Thread		Nipplo M/M Gas M/M BSP Nipple		Nipplo M.Gas/M.conico M.BSP/M.BSPT Nipple
Inch	Inch		Codice / Part. nr.		Codice / Part. nr.
G 1/8"-28	G 1/8"-27	●*	302 050 202	●	302 150 202
G 1/8"	G 1/4"		302 050 204		
G 1/4"-19	G 1/4"-18	●*	302 050 404	●	302 150 404
G 3/8"-19	G 3/8"-18	●*	302 050 606		302 150 606
G 3/8"	G 1/2"		302 050 608		
G 1/2"-14	G 1/2"-14	●*	302 050 808		302 150 808
G 3/4"-14	G 3/4"-14	●*	302 051 212		302 151 212
G 1"-11	G 1"-11,5	●	302 051 616		302 151 616
G 1.1/4"-11	G 1.1/4"-11,5	●*	302 052 020	●	302 052 020
G 1.1/2"-11	G 1.1/2"-11,5	●*	302 052 424	●	302 152 424
G 2"-11	G 2"-11,5	●*	302 053 232	●	302 153 232
G 2"-11	G 2"-11	●*	300 003 232	●	302 003 232



BSP / BSPT

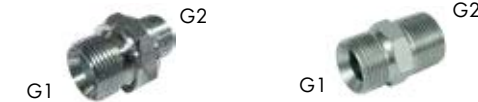

Filetto G1 G1 Thread	Filetto G2 G2 Thread		Riduzione M/M Gas M/M BSP Reducing		Riduzione M.Gas/M.conico M.BSP/M.BSPT Reducing
Inch	Inch		Codice / Part. nr.		Codice / Part. nr.
G 1/4"-19	G 1/8"-28	*	304 000 402		304 500 402
G 1/4"-19	G 3/8"-19				304 500 406
G 1/4"-19	G 1/2"-14				304 500 408
G 3/8"-19	G 1/8"-28	*	304 000 602		
G 3/8"-19	G 1/4"-19	*	304 000 604	●	304 500 604
G 3/8"-19	G 1/2"-14				304 500 608
G 1/2"-14	G 1/8"-28		304 000 802		
G 1/2"-14	G 1/4"-19	*	304 000 804	●	304 500 804
G 1/2"-14	G 3/8"-19	*	304 000 806	●	304 500 806
G 1/2"-14	G 3/4"-14				304 500 812
G 1/2"-14	G 1"-11			●	304 500 816
G 5/8"-14	G 3/8"-19	●	304 001 006		
G 5/8"-14	G 1/2"-14		304 001 008		
G 3/4"-14	G 1/4"-19	*	304 001 204		
G 3/4"-14	G 3/8"-19	*	304 001 206		
G 3/4"-14	G 1/2"-14	*	304 001 208	●	304 501 208
G 3/4"-14	G 5/8"-14		304 001 210		
G 3/4"-14	G 1"-11			●	304 501 216
G 1"-11	G 1/4"-19		304 001 604		
G 1"-11	G 3/8"-19		304 001 606		
G 1"-11	G 1/2"-14	*	304 001 608		
G 1"-11	G 5/8"-14		304 001 610		
G 1"-11	G 3/4"-14	*	304 001 612	●	304 501 612
G 1"-11	G 1.1/4"-11			●	304 501 620
G 1.1/4"-11	G 1/2"-14		304 002 008		
G 1.1/4"-11	G 3/4"-14	*	304 002 012		
G 1.1/4"-11	G 1"-11	*	304 002 016	●	304 502 016
G 1.1/2"-11	G 1/2"-14				
G 1.1/2"-11	G 3/4"-14	*	304 002 412		
G 1.1/2"-11	G 1"-11	*	304 002 416		
G 1.1/2"-11	G 1.1/4"-11	*	304 002 420		
G 2"-11	G 1"-11	*	304 003 216		
G 2"-11	G 1.1/4"-11	*	304 003 220		
G 2"-11	G 1.1/2"-11	*	304 003 224		
G 2.1/2"-11	G 2"-11	●	304 004 032		
G 3"-11	G 2.1/2"-11	●	304 004 840		

● Fornibile in 7 gg lavorativi / Available in 7 working days

* Fornibile anche in Acciaio Inox / Also Stainless Steel available

● Fornibile in 7 gg lavorativi / Available in 7 working days

* Fornibile anche in Acciaio Inox / Also Stainless Steel available



METRICO



BSP / METRICO



Filetto G1 G1 Thread	Filetto G2 G2 Thread	Nipplo M/M Metrico M/M Metric Nipple	Riduzione M/M Metrico M/M Metric Reducing	Filetto G1 G1 Thread	Filetto G2 G2 Thread	Nipplo M/M Gas/ Metr. M/M BSP/ Met. Nipple
mm	mm	Codice / Part. nr.	Codice / Part. nr.	Inch	Inch	Codice / Part. nr.
M 10x1	M 10x1	303 000 100		G 1/8"-28	M 10x1	304 102 100
M 12x1,5	M 10x1		304 122 100	G 1/8"-28	M 12x1,5	304 102 122
M 12x1,5	M 12x1,5	303 000 122		G 1/8"-28	M 14x1,5	● 304 102 142
M 14x1,5	M 10x1		304 142 100	G 1/4"-19	M 10x1	304 104 100
M 14x1,5	M 12x1,5		304 142 122	G 1/4"-19	M 12x1,5	304 104 122
M 14x1,5	M 14x1,5	303 000 142		G 1/4"-19	M 14x1,5	304 104 142
M 16x1,5	M 12x1,5		304 162 122	G 1/4"-19	M 16x1,5	304 104 162
M 16x1,5	M 14x1,5		304 162 142	G 1/4"-19	M 18x1,5	304 104 182
M 16x1,5	M 16x1,5	303 000 162		G 1/4"-19	M 22x1,5	● 304 104 222
M 18x1,5	M 14x1,5		● 304 182 142	G 3/8"-19	M 12x1,5	304 106 122
M 18x1,5	M 16x1,5		304 182 162	G 3/8"-19	M 14x1,5	304 106 142
M 18x1,5	M 18x1,5	303 000 182		G 3/8"-19	M 16x1,5	304 106 162
M 20x1,5	M 14x1,5		304 202 142	G 3/8"-19	M 18x1,5	304 106 182
M 20x1,5	M 16x1,5		304 202 162	G 3/8"-19	M 20x1,5	304 106 202
M 20x1,5	M 18x1,5		● 304 202 182	G 3/8"-19	M 22x1,5	304 106 222
M 20x1,5	M 20x1,5	303 000 202		G 1/2"-14	M 12x1,5	● 304 108 122
M 22x1,5	M 14x1,5		304 222 142	G 1/2"-14	M 14x1,5	304 108 142
M 22x1,5	M 16x1,5		304 222 162	G 1/2"-14	M 16x1,5	304 108 162
M 22x1,5	M 18x1,5		304 222 182	G 1/2"-14	M 18x1,5	304 108 182
M 22x1,5	M 20x1,5		304 222 202	G 1/2"-14	M 20x1,5	304 108 202
M 22x1,5	M 22x1,5	303 000 222		G 1/2"-14	M 22x1,5	304 108 222
M 24x1,5	M 18x1,5		● 304 242 182	G 1/2"-14	M 24x1,5	304 108 242
M 24x1,5	M 22x1,5		● 304 242 222	G 1/2"-14	M 26x1,5	● 304 108 262
				G 1/2"-14	M 27x2	304 108 273
M 24x1,5	M 24x1,5	303 000 242		G 5/8"-14	M 18x1,5	● 304 110 182
M 26x1,5	M 22x1,5		● 304 262 222	G 5/8"-14	M 20x1,5	● 304 110 202
M 26x1,5	M 24x1,5		● 304 262 242	G 5/8"-14	M 22x1,5	● 304 110 222
M 26x1,5	M 26x1,5	303 000 262		G 3/4"-14	M 18x1,5	304 112 182
M 30x1,5	M 22x1,5		● 304 302 222	G 3/4"-14	M 22x1,5	304 112 222
M 30x1,5	M 26x1,5		● 304 302 262	G 3/4"-14	M 26x1,5	304 112 262
M 30x1,5	M 30x1,5	303 000 302		G 3/4"-14	M 30x1,5	304 112 302
				G 3/4"-14	M 33x2	304 112 333
				G 1"-11	M 22x1,5	304 116 222
				G 1"-11	M 26x1,5	304 116 262
				G 1"-11	M 30x1,5	● 304 116 302
				G 1.1/4"-11	M 30x1,5	● 304 120 302
				G 1.1/4"-11	M 38x1,5	● 304 120 382

● Fornibile in 7 gg lavorativi / Available in 7 working days



BSP



Filetto Thread	Lungh. Esagono Hexagon Leng.	Prolunga M/F Gas M/F BSP Extension	Prolunga M/M Gas M/M BSP Extension
Inch	mm	Codice / Part. nr.	Codice / Part. nr.
G 1/8"-28	L. 17/20	* 400 000 220	
G 1/8"-28	L. 28/32	●* 400 000 230	
G 1/4"-19	L. 20/22	* 400 000 420	
G 1/4"-19	L. 30/31	400 000 430	●* 400 010 430
G 1/4"-19	L. 39/40	* 400 000 440	
G 1/4"-19	L. 50	●* 400 000 450	
G 3/8"-19	L. 20/22	* 400 000 620	●* 400 010 625
G 3/8"-19	L. 29/30	* 400 000 630	● 400 010 630
G 3/8"-19	L. 39/41	400 000 640	
G 3/8"-19	L. 50	* 400 000 650	
G 1/2"-14	L. 23/26	* 400 000 825	
G 1/2"-14	L. 30/31	* 400 000 830	●* 400 010 830
G 1/2"-14	L. 40/45	400 000 840	400 010 840
G 1/2"-14	L. 50/51	* 400 000 850	
G 1/2"-14	L. 60/61	400 000 860	
G 5/8"-14	L. 45	● 400 001 045	
G 3/4"-14	L. 29/30	* 400 001 230	
G 3/4"-14	L. 40/41	* 400 001 240	●* 400 011 240
G 3/4"-14	L. 48/52	* 400 001 250	
G 3/4"-14	L. 60		● 400 011 260
G 3/4"-14	L. 80/81	● 400 001 280	
G 1"-11	L. 30/31	* 400 001 630	
G 1"-11	L. 40/42	400 001 640	
G 1"-11	L. 50		●* 400 011 650
G 1"-11	L. 60/62	400 001 660	● 400 011 660
G 1"-11	L. 70	400 001 670	
G 1.1/4"-11	L. 40/42	400 002 040	
G 1.1/4"-11	L. 60		●* 400 012 060
G 1.1/4"-11	L. 70/72	* 400 002 070	
G 1.1/2"-11	L. 34/35	●* 400 002 435	
G 1.1/2"-11	L. 73/76	●* 400 002 475	
G 2"-11	L. 35/37	● 400 003 235	
G 2"-11	L. 49/50	●* 400 003 250	
G 2"-11	L. 100/2	● 400 032 100	
G 2.1/2"-11	L. 35	● 400 004 035	

● Fornibile in 7 gg lavorativi / Available in 7 working days

* Fornibile anche in Acciaio Inox / Also Stainless Steel available



BSP



Filetto Thread	Lung. Esagono Hexagon Leng.	Prolunga F/F Gas F/F BSP Extension	Prolunga F/F Gas F/F BSP Extension
Inch	mm	Codice / Part. nr.	Codice / Part. nr.
G 1/8"-28	L. 20	* 400 020 220	400 020 202
G 1/8"-28	L. 30	400 020 230	
G 1/4"-19	L. 30	* 400 020 430	400 020 404
G 3/8"-19	L. 30	* 400 020 630	400 020 606
G 1/2"-14	L. 30		400 020 808
G 1/2"-14	L. 40	* 400 020 840	
G 5/8"-14	L. 35	400 021 035	
G 3/4"-14	L. 40	* 400 021 240	● 400 021 212
G 1"-11	L. 40		● 400 021 616
G 1"-11	L. 50	* 400 021 650	
G 1.1/4"-11	L. 40		● 400 022 020
G 1.1/4"-11	L. 50	* 400 022 050	
G 1.1/2"-11	L. 35		● 400 024 024
G 1.1/2"-11	L. 50	●* 400 022 450	
G 2"-11	L. 55	●* 400 023 255	

RIDUZIONE F/F GIREVOLE BSP



Filetto G1 G1 Thread	Filetto G2 G2 Thread	Riduzione Fg/Fg Gas Fg/Fg BSP Reducing
Inch	Inch	Codice / Part. nr.
G 1/8"-28	G 1/4"-19	● 400 020 204
G 1/4"-19	G 3/8"-19	● 400 020 406
G 1/4"-19	G 1/2"-14	● 400 020 408
G 1/2"-14	G 5/8"-14	● 400 020 810
G 1/2"-14	G 3/4"-14	● 400 020 812
G 1"-11	G 1/2"-14	● 400 021 608
G 1"-11	G 3/4"-14	● 400 021 612
G 1.1/4"-1	G 1"	● 400 022 016

● Fornibile in 7 gg lavorativi / Available in 7 working days

* Fornibile anche in Acciaio Inox / Also Stainless Steel available



BSP



BSP



Filetto G1 G1 Thread	Filetto G2 G2 Thread	Riduzione Alta M/F Gas M/F BSP Long Reducing	Filetto G1 G1 Thread	Filetto G2 G2 Thread	Riduzione Bassa M/F Gas M/F BSP Short Reducing
Inch	Inch	Codice / Part. nr.	Inch	Inch	Codice / Part. nr.
G 1/8"-28	G 1/4"-19	* 400 040 204	G 1/4"-19	G 1/8"-28	* 400 030 402
G 1/8"-28	G 3/8"-19	400 040 206	G 3/8"-19	G 1/8"-28	* 400 030 602
G 1/4"-19	G 1/8"-28	400 040 402	G 3/8"-19	G 1/4"-19	* 400 030 604
G 1/4"-19	G 3/8"-19	* 400 040 406	G 1/2"-14	G 1/8"-28	400 030 802
G 1/4"-19	G 1/2"-14	* 400 040 408	G 1/2"-14	G 1/4"-19	* 400 030 804
G 1/4"-19	G 1/2"	400 040 412	G 1/2"-14	G 3/8"-19	* 400 030 806
G 3/8"-19	G 1/4"-19	* 400 040 604	G 3/4"-14	G 1/4"-19	* 400 031 204
G 3/8"-19	G 1/2"-14	* 400 040 608	G 3/4"-14	G 3/8"-19	* 400 031 206
G 3/8"-19	G 3/4"-14	* 400 040 612	G 3/4"-14	G 1/2"-14	* 400 031 208
G 3/8"-19	G 1"-11	400 040 616	G 1"-11	G 1/4"-19	400 031 604
G 1/2"-14	G 1/4"-19	400 040 804	G 1"-11	G 3/8"-19	400 031 606
G 1/2"-14	G 3/8"-19	* 400 040 806	G 1"-11	G 1/2"-14	* 400 031 608
G 1/2"-14	G 3/4"-14	* 400 040 812	G 1"-11	G 3/4"-14	* 400 031 612
G 1/2"-14	G 1"-11	* 400 040 816	G 1.1/4"-11	G 1/2"-14	400 032 008
G 1/2"-14	G 1.1/4"-11	● 400 040 820	G 1.1/4"-11	G 3/4"-14	* 400 032 012
G 1/2"-14	G 1.1/2"-11	● 400 040 824	G 1.1/4"-11	G 1"-11	* 400 032 016
G 3/4"-14	G 1/4"-19	400 041 204	G 1.1/2"-11	G 1/2"-14	● 400 032 408
G 3/4"-14	G 3/8"-19	400 041 206	G 1.1/2"-11	G 3/4"-14	●* 400 032 412
G 3/4"-14	G 1/2"-14	* 400 041 208	G 1.1/2"-11	G 1"-11	* 400 032 416
G 3/4"-14	G 1"-11	* 400 041 216	G 1.1/2"-11	G 1.1/4"-11	* 400 032 420
G 3/4"-14	G 1.1/4"-11	400 041 220	G 2"-11	G 1"-11	●* 400 033 216
G 1"-11	G 3/8"-19	● 400 041 606	G 2"-11	G 1.1/4"-11	* 400 033 220
G 1"-11	G 1/2"-14	400 041 608	G 2"-11	G 1.1/2"-11	* 400 033 224
G 1"-11	G 3/4"-14	* 400 041 612			
G 1"-11	G 1.1/4"-11	* 400 041 620			
G 1"-11	G 1.1/2"-11	400 041 624			
G 1.1/4"-11	G 1/2"-14	● 400 042 008			
G 1.1/4"-11	G 3/4"-14	400 042 012			
G 1.1/4"-11	G 1"-11	* 400 042 016			
G 1.1/4"-11	G 1.1/2"-11	●* 400 042 024			
G 1.1/2"-11	G 3/4"-14	● 400 042 412			
G 1.1/2"-11	G 1"-11	400 042 416			
G 1.1/2"-11	G 1.1/4"-11	* 400 042 420			
G 1.1/2"-11	G 2"-11	* 400 042 432			
G 2"-11	G 1"-11	● 400 043 216			
G 2"-11	G 1.1/4"-11	● 400 043 220			
G 2"-11	G 1.1/2"-11	●* 400 043 224			

● Fornibile in 7 gg lavorativi / Available in 7 working days

* Fornibile anche in Acciaio Inox / Also Stainless Steel available



METRICHE



Filetto Thread	Lungh. Esagono Hexagon Leng.	Prolunga M/F Metrica M/F Metric Extension	Prolunga F/F Metrica F/F Metric Extension
Inch	mm	Codice / Part. nr.	Codice / Part. nr.
M 10x1	L. 15/17	● 400 100 015	
M 10x1	L. 25/31	● 400 100 030	400 210 025
M 12x1,5	L. 20	● 400 122 020	
M 12x1,5	L. 25		400 212 225
M 14x1,5	L. 17/25	● 400 142 020	● 400 214 225
M 14x1,5	L. 35/36	● 400 142 035	400 214 235
M 16x1,5	L. 20	400 162 020	
M 16x1,5	L. 35/40	400 162 040	● 400 216 235
M 18x1,5	L. 20	400 182 020	
M 18x1,5	L. 30	● 400 182 030	● 400 218 230
M 18x1,5	L. 40	● 400 182 040	
M 18x1,5	L. 45		● 400 218 245
M 20x1,5	L. 25	400 202 025	
M 20x1,5	L. 45	● 400 202 045	
M 22x1,5	L. 25	● 400 222 025	
M 22x1,5	L. 40		● 400 222 240
M 22x1,5	L. 45	● 400 222 045	
M 26x1,5	L. 25	● 400 262 025	

RIDUZIONI M/F METRICHE

METRICHE



Filetto G1 G1 Thread	Filetto G2 G2 Thread	Riduzione Alta M/F Metrica M/F Metric Long Reducing
Inch	Inch	Codice / Part. nr.
M 18x1,5	M 12x1,5	
M 18x1,5	M 14x1,5	● 400 061 814
M 18x1,5	M 22x1,5	● 400 061 822
M 22x1,5	M 18x1,5	● 400 062 218

● Fornibile in 7 gg lavorativi / Available in 7 working days



BPS / METRICHE

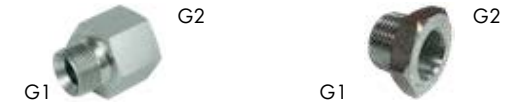

Filetto G1 G1 Thread	Filetto G2 G2 Thread	Riduzione Alta M Gas/F Metrica M BSP/F Metric Long Reducing	Riduzione Bassa M Gas/F Metrica M BSP/F Metric Short Reducing
Inch	mm	Codice / Part. nr.	Codice / Part. nr.
G 1/4"-19	M 10x1	400 060 410	
G 1/4"-19	M 14x1,5	400 060 414	
G 3/8"-19	M 12x1,5		400 030 612
G 3/8"-19	M 14x1,5	400 060 614	400 030 614
G 3/8"-19	M 16x1,5	400 060 616	
G 3/8"-19	M 18x1,5	400 060 618	
G 3/8"-19	M 22x1,5	400 060 622	
G 1/2"-14	M 12x1,5		● 400 030 812
G 1/2"-14	M 14x1,5	● 400 060 814	● 400 030 814
G 1/2"-14	M 16x1,5	400 060 816	
G 1/2"-14	M 18x1,5	400 060 818	
G 1/2"-14	M 22x1,5	400 060 822	
G 3/4"-14	M 18x1,5	● 400 061 218	● 400 031 218

BPS / METRICHE

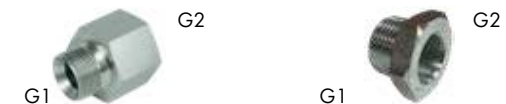

Filetto G1 G1 Thread	Filetto G2 G2 Thread	Riduzione Alta M Metrico/F Gas M Metric/F BSP Long Reducing	Riduzione Bassa M Metrico/F Gas M Metric/F BSP Short Reducing
Inch	mm	Codice / Part. nr.	Codice / Part. nr.
M 10x1	G 1/8"-28	● 400 061 002	
M 14x1,5	G 1/4"-19	400 061 404	
M 16x1,5	G 1/4"-19	400 061 604	
M 18x1,5	G 1/4"-19	● 400 061 804	● 400 031 804
M 22x1,5	G 1/4"-19	400 062 204	400 032 204
M 14x1,5	G 3/8"-19	400 061 406	
M 16x1,5	G 3/8"-19	400 061 606	
M 18x1,5	G 3/8"-19	400 061 806	
M 22x1,5	G 3/8"-19	400 062 206	400 032 206
M 18x1,5	G 1/2"-14	400 061 808	
M 22x1,5	G 1/2"-14	400 062 208	

● Fornibile in 7 gg lavorativi / Available in 7 working days

* Fornibile anche in Acciaio Inox / Also Stainless Steel available



**MASCHIO / FEMMINA
GIREVOLE BSP**



Filetto G1 G1 Thread	Filetto G2 G2 Thread		Adattatore M/Fg Gas M/Fg BSP Adaptors		Adattatore 90° M/Fg Gas 90° M/Fg BSP Adaptors		Adattatore 45° M/Fg Gas 45° M/Fg BSP Adaptors
Inch	Inch		Codice / Part. nr.		Codice / Part. nr.		Codice / Part. nr.
G 1/8"-28	G 1/8"-28	●	401 010 202	●	490 000 202	●	445 000 202
G 1/4"-19	G 1/4"-19	Sp*	401 000 404	Sp*	490 000 404	Sp*	445 000 404
G 3/8"-19	G 3/8"-19	Sp*	401 000 606	Sp*	490 000 606	Sp*	445 000 606
G 1/2"-14	G 1/2"-14	Sp*	401 000 808	Sp*	490 000 808	Sp*	445 000 808
G 5/8"-14	G 5/8"-14		401 001 010		490 001 010	●	445 001 010
G 3/4"-14	G 3/4"-14	Sp*	401 001 212	Sp*	490 001 212	Sp*	445 001 212
G 1"-11	G 1"-11	Sp*	401 001 616	Sp*	490 001 616	Sp*	445 001 616
G 1.1/4"-11	G 1.1/4"-11	Sp*	401 002 020	*	490 002 020	●*	445 002 020
G 1.1/2"-11	G 1.1/2"-11	Sp●	401 002 424		490 002 424	●	445 002 424
G 2"-11	G 2"-11	●	401 003 232		490 003 232	●	445 003 232

Sp. : Fornibile con dato spinato

**RIDUZIONE M/F
GIREVOLE BSP**



Filetto G1 G1 Thread	Filetto G2 G2 Thread		Riduzione M/Fg Gas M/Fg BSP Reducing
Inch	Inch		Codice / Part. nr.
G 1/8"-28	G 1/4"-19	●	401 000 204
G 1/4"-19	G 3/8"-19		401 000 406
G 1/4"-19	G 1/2"-14		401 000 408
G 3/8"-19	G 1/4"-19		401 000 604
G 3/8"-19	G 1/2"-14		401 000 608
G 3/8"-19	G 3/4"-14		401 000 612
G 1/2"-14	G 1/4"-19		401 000 804
G 1/2"-14	G 3/8"-19		401 000 806
G 1/2"-14	G 5/8"-14	●	401 000 810
G 1/2"-14	G 3/4"-14		401 000 812
G 3/4"-14	G 3/8"-19	●	401 001 206
G 3/4"-14	G 1/2"-14		401 001 208
G 3/4"-14	G 1"-11		401 001 216
G 1"-11	G 3/4"-14		401 001 612
G 1"-11	G 1.1/4"-11	●	401 001 620
G 1.1/4"-11	G 1"-11	●	401 002 016

● Fornibile in 7 gg lavorativi / Available in 7 working days

* Fornibile anche in Acciaio Inox / Also Stainless Steel available



**MASCHIO / FEMMINA
GIREVOLE METRICI**



Filetto G1 G1 Thread	Filetto G2 G2 Thread		Adattatore M/Fg Metr. M/Fg Metric Adaptors		Adattatore 90° M/Fg Metr. 90° M/Fg Metr. Adaptors		Adattatore 45° M/Fg Metr. 45° M/Fg Metr. Adaptors
mm	mm		Codice / Part. nr.		Codice / Part. nr.		Codice / Part. nr.
M 10x1	M 10x1			●	490 000 100	●	445 000 100
M 12x1,5	M 12x1,5	●	401 000 122	●	490 000 122	●	445 000 122
M 14x1,5	M 14x1,5		401 000 142	●	490 000 142	●	445 000 142
M 16x1,5	M 16x1,5		401 000 162	●	490 000 162	●	445 000 162
M 18x1,5	M 18x1,5		401 000 182	●	490 000 182	●	445 000 182
M 20x1,5	M 20x1,5	●	401 000 202	●	490 002 002	●	445 010 202
M 22x1,5	M 22x1,5	●	401 000 222	●	490 000 222	●	445 000 222
M 24x1,5	M 24x1,5	●	401 000 242	●	490 000 242	●	445 000 242
M 26x1,5	M 26x1,5	●	401 000 262	●	490 000 262	●	445 000 262
M 30x1,5	M 30x1,5	●	401 000 302				

**RIDUZIONE M.BSP
F.GIREVOLE METRICA**



Filetto G1 G1 Thread	Filetto G2 G2 Thread		Riduzione M Gas/Fg Metr. M BSP/Fg Metric Reducing
mm	mm		Codice / Part. nr.
G 1/4"-19	M 14x1,5	●	401 004 142
G 3/8"-19	M 18x1,5		401 006 182
G 1/2"-14	M 22x1,5		401 008 222

**RIDUZIONE
M.METRICO
F.GIREVOLE BSP**



Filetto G1 G1 Thread	Filetto G2 G2 Thread		Riduzione M Metr./Fg Gas M Metric/Fg BSP Reducing
mm	mm		Codice / Part. nr.
M 16x1,5	G 1/4"-19		401 162 004
M 18x1,5	G 3/8"-19		401 182 006
M 18x1,5	G 1/2"-14		401 182 008

● Fornibile in 7 gg lavorativi / Available in 7 working days

* Fornibile anche in Acciaio Inox / Also Stainless Steel available



**FEMMINA / FEMMINA
GIREVOLE BSP**



Filetto G1 G1 Thread	Filetto G2 G2 Thread		Adattatore Fg/Fg Gas Fg/Fg BSP Adaptors		Adattatore 90° Fg/Fg Gas 90° Fg/Fg BSP Adaptors		Adattatore 45° Fg/Fg Gas 45° Fg/Fg BSP Adaptors
Inch	Inch		Codice / Part. nr.		Codice / Part. nr.		Codice / Part. nr.
G 1/8"-28	G 1/8"-28	●	401 100 202	●	490 100 202	●	445 100 202
G 1/4"-19	G 1/4"-19	Sp*	401 100 404	*	490 100 404	●*	445 100 404
G 3/8"-19	G 3/8"-19	Sp*	401 100 606	*	490 100 606	●*	445 100 606
G 1/2"-14	G 1/2"-14	Sp*	401 100 808	*	490 100 808	●*	445 100 808
G 5/8"-14	G 5/8"-14		401 101 010	●	490 101 010	●	445 101 010
G 3/4"-14	G 3/4"-14	Sp*	401 101 212	*	490 101 212	●*	445 101 212
G 1"-11	G 1"-11	Sp*	401 101 616	*	490 101 616	●*	445 101 616
G 1.1/4"-11	G 1.1/4"-11	●*	401 102 020	●*	490 102 020	●*	445 102 020
G 1.1/2"-11	G 1.1/2"-11	●	401 102 424	●	490 102 424	●	445 102 424
G 2"-11	G 2"-11	●	401 103 232	●	490 103 232	●	445 103 232

Sp. : Fornibile con dato spinato

ADATTATORI F./F. GIREVOLE METRICI

**FEMMINA / FEMMINA
GIREVOLE METRICI**



Filetto G1 G1 Thread	Filetto G2 G2 Thread		Adattatore Fg/Fg Metrico Fg/Fg Metric Adaptors		Adattatore 90° Fg/Fg Metrico 90° Fg/Fg Metric Adaptors		Adattatore 45° Fg/Fg Metrico 45° Fg/Fg Metric Adaptors
mm	mm		Codice / Part. nr.		Codice / Part. nr.		Codice / Part. nr.
M 10x1	M 10x1	●	401 100 100	●	490 100 100		
M 12x1,5	M 12x1,5	●	401 100 122	●	490 100 122		
M 14x1,5	M 14x1,5	●	401 100 142	●	490 100 142	●	445 100 142
M 16x1,5	M 16x1,5	●	401 100 162	●	490 100 162	●	445 100 162
M 18x1,5	M 18x1,5	●	401 100 182	●	490 100 182	●	445 101 182
M 20x1,5	M 20x1,5	●	401 200 202	●	490 110 202		
M 22x1,5	M 22x1,5	●	401 100 222	●	490 100 222	●	445 101 222
M 24x1,5	M 24x1,5	●	401 100 242	●	490 100 242		
M 26x1,5	M 26x1,5	●	401 100 262	●	490 100 262		

● Fornibile in 7 gg lavorativi / Available in 7 working days

* Fornibile anche in Acciaio Inox / Also Stainless Steel available



BSP / BSPT



Filetto Thread	Tappo Femmina Gas Female BSP Plug	Tappo Maschio Gas Male BSP Plug	Tappo Maschio Gas conico Male BSP Plug
Inch	Codice / Part. nr.	Codice / Part. nr.	Codice / Part. nr.
G 1/8"-28	400 050 102	* 400 050 002	
G 1/4"-19	* 400 050 104	* 400 050 004	● 400 152 104
G 3/8"-19	* 400 050 106	* 400 050 006	● 400 152 106
G 1/2"-14	* 400 050 108	* 400 050 008	● 400 152 108
G 5/8"-14	400 050 110	400 050 010	
G 3/4"-14	* 400 050 112	* 400 050 012	● 400 152 112
G 1"-11	* 400 050 116	* 400 050 016	● 400 152 116
G 1.1/4"-11	* 400 050 120	* 400 050 020	
G 1.1/2"-11	* 400 050 124	* 400 050 024	
G 2"-11	400 050 132	●* 400 050 032	
G 2.1/2"-11		● 400 050 040	
G 3"-11		● 400 050 048	

BSP / BSPT



Filetto Thread	Tappo Maschio esagono incassato Gas conico Male BSPT Plug with inner exagon	Tappo Maschio Gas esagono incassato con battuta Male BSP Blanking Plug with inner exagon	Tappo Maschio Gas esagono incassato con battuta e O-ring Male BSP Blanking Plug with inner ex. and O-ring
Inch	Codice / Part. nr.	Codice / Part. nr.	Codice / Part. nr.
G 1/8"-28	400 150 002	400 250 002	400 350 002
G 1/4"-19	400 150 004	400 250 004	400 350 004
G 3/8"-19	400 150 006	400 250 006	400 350 006
G 1/2"-14	400 150 008	400 250 008	400 350 008
G 5/8"-14	● 400 150 010		
G 3/4"-14	● 400 150 012	400 250 012	400 350 012
G 1"-11	● 400 150 016	● 400 250 016	400 350 016
G 1.1/4"-11	● 400 150 020	● 400 250 020	400 350 020
G 1.1/2"-11	● 400 150 024	● 400 250 024	● 400 350 024
G 2"-11		● 400 250 032	● 400 350 032

● Fornibile in 7 gg lavorativi / Available in 7 working days

* Fornibile anche in Acciaio Inox / Also Stainless Steel available

TAPPI NPT

NPT



Filetto Thread	Tappo Maschio NPT NPT BSP Plug
Inch	Codice / Part. nr.
G 1/8"-27	• 400 252 102
G 1/4"-18	• 400 252 104
G 3/8"-18	• 400 252 106
G 1/2"-14	• 400 252 108
G 3/4"-14	• 400 252 112
G 1"-11,5	• 400 252 116
G 1.1/4"-11,5	• 400 252 120
G 1.1/2"-11,5	• 400 252 124
G 2"-11,5	• 400 252 132

TAPPI METRICI

METRICI



Filetto Thread	Tappo Femmina Metrico Female Metric Plug	Tappo Maschio Metrico Male Metric Plug	Tappo Maschio esagono incas. con battuta e O-ring Male BSP Blanking Plug with inner ex. and O-ring
mm	Codice / Part. nr.	Codice / Part. nr.	Codice / Part. nr.
M 8x1		400 051 080	
M 10x1	400 050 100	400 051 100	400 350 100
M 12x1,5	400 050 122	400 051 122	400 350 122
M 14x1,5	400 050 142	400 051 142	400 350 142
M 16x1,5	400 050 162	400 051 162	400 350 162
M 18x1,5	400 050 182	400 051 182	400 350 182
M 20x1,5	400 050 202	400 051 202	400 350 202
M 22x1,5	400 050 222	400 051 222	400 350 222
M 24x1,5	400 050 242	400 051 242	
M 26x1,5	400 050 262	400 051 262	• 400 350 262
M 27x2			• 400 350 273
M 28x1,5	• 400 050 282	400 051 282	
M 30x1,5	• 400 050 302	400 051 302	
M 33x2			• 400 350 333
M 42x2			• 400 350 423
M 48x2			• 400 350 483

• Fornibile in 7 gg lavorativi / Available in 7 working days

* Fornibile anche in Acciaio Inox / Also Stainless Steel available

VITI FORATE BSP

BSP



Filetto Thread	Vite Forata Gas BSP Bolt	Vite Forata Doppia Gas Double BSP Bolt
Inch	Codice / Part. nr.	Codice / Part. nr.
G 1/8"-28	203 000 202	203 100 202
G 1/4"-19	* 203 000 404	* 203 100 404
G 3/8"-19	* 203 000 606	* 203 100 606
G 1/2"-14	* 203 000 808	* 203 100 808
G 5/8"-14	203 001 010	• 203 101 010
G 3/4"-14	* 203 001 212	•* 203 101 212
G 1"-11	* 203 001 616	•* 203 101 616
G 1.1/4"-11	• 203 002 020	

OCCHI FILETTATI BSP

BSP



Ø Occhio Banjo Ø	Filetto Thread	Occhio Filettato Gas BSP Banjo Threaded	Occhio Filettato Gas con Battuta BSP Banjo Threaded with guide
Inch	Inch	Codice / Part. nr.	Codice / Part. nr.
G 1/8"-28	G 1/8"-28	201 710 202	
G 1/4"-19	G 1/4"-19	201 710 404	201 720 404
G 3/8"-19	G 1/4"-19	• 201 710 604	
G 3/8"-19	G 3/8"-19	201 710 606	201 720 606
G 3/8"-19	G 1/2"-14	• 201 710 608	
G 1/2"-14	G 1/4"-19	• 201 710 804	
G 1/2"-14	G 3/8"-19	• 201 710 806	
G 1/2"-14	G 1/2"-14	201 710 808	• 201 720 808
G 3/4"-14	G 1/2"-14	• 201 711 208	
G 3/4"-14	G 3/4"-14	• 201 711 212	• 201 721 212
G 1"-11	G 1"-11	• 201 711 616	

• Fornibile in 7 gg lavorativi / Available in 7 working days

* Fornibile anche in Acciaio Inox / Also Stainless Steel available

VITI FORATE METRICHE



METRICHE



Filetto Thread	Vite Forata Metrica Metric Bolt	Vite Forata Doppia Metrica Double Metric Bolt
mm	Codice / Part. nr.	Codice / Part. nr.
M 6x1	203 000 060	
M 8x1	• 203 000 080	203 100 080
M 8x1,25	203 000 081	203 100 081
M 8x1,5	203 000 082	203 100 082
M 10x1	203 000 100	203 100 100
M 10x1,25	203 000 101	203 100 101
M 10x1,5	203 000 102	
M 12x1	• 203 000 120	
M 12x1,25	203 000 121	
M 12x1,5	203 000 122	203 100 122
M 14x1,5	203 000 142	203 100 142
M 16x1,5	203 000 162	203 100 162
M 18x1,5	203 000 182	203 100 182
M 20x1,5	• 203 001 202	• 203 101 202
M 22x1,5	203 000 222	203 100 222
M 24x1,5	203 000 242	
M 26x1,5	• 203 000 262	• 203 100 262
M 30x1,5	• 203 000 302	

OCCHI FILETTATI METRICI

METRICO



Ø Occhio Banjo Ø	Filetto Thread	Occhio Filettato Metrico Metric Banjo Threaded
mm	mm	Codice / Part. nr.
M 10x1	M 10x1	• 201 710 100
M 12x1,5	M 12x1,5	• 201 710 122
M 14x1,5	M 14x1,5	• 201 710 142
M 16x1,5	M 16x1,5	• 201 710 162
M 18x1,5	M 18x1,5	• 201 710 182
M 20x1,5	M 20x1,5	• 201 710 212
M 22x1,5	M 22x1,5	• 201 710 222
M 24x1,5	M 24x1,5	• 201 710 242
M 26x1,5	M 26x1,5	• 201 711 262

• Fornibile in 7 gg lavorativi / Available in 7 working days

OCCHI BSP/DIN



BSP



Ø Occhio Banjo Ø	Ø Tubo Tube OD	Lunghezza Length	Occhio Gas con Estremità Tubolare BSP Banjo with Standpipe	Ø Occhio Banjo Ø	Ø Tubo Tube OD	Occhio Gas con Dado e Ogiva DIN BSP Banjo with DIN nut and olive
Inch	mm	mm	Codice / Part. nr.	Inch	mm	Codice / Part. nr.
G 1/4"-19	12	100	• 201 704 100	G 1/4"-19	8L	201 704 008
G 1/4"-19	12	200	201 704 200			
G 3/8"-19	12	40	201 706 040	G 3/8"-19	8L	201 706 008
G 3/8"-19	12	100	201 706 100	G 3/8"-19	10L	201 706 010
G 3/8"-19	12	200	201 706 200			
G 3/8"-19	12	300	201 706 300			
G 3/8"-19	12	400	201 706 400			
G 3/8"-19	12	500	201 706 500			
G 3/8"-19	12L			G 3/8"-19	12L	201 706 012
G 1/2"-14	12	45	• 201 708 045	G 1/2"-14	12L	201 708 012
G 1/2"-14	15	45	• 201 718 045	G 1/2"-14	15L	201 706 015

PASSAPARETE M/M

BSP



METRICO



Filetto Thread	Passaparete Gas completo di dado BSP Bulkhead nut completed	Filetto Thread	Passaparete Metrico completo di dado Metric Bulkhead nut completed
Inch	Codice / Part. nr.	mm	Codice / Part. nr.
G 1/8"-28	* 305 000 202	M 14x1,5	• 305 000 142
G 1/4"-19	* 305 000 404	M 16x1,5	• 305 000 162
G 3/8"-19	* 305 000 606	M 18x1,5	• 305 000 182
G 1/2"-14	305 000 808	M 22x1,5	• 305 000 222
G 5/8"-14	* 305 001 010		
G 3/4"-14	* 305 001 212		
G 1"-11	* 305 001 616		
G 1.1/4"-11	• 305 002 020		
G 1.1/2"-11	• 305 002 424		
G 2"-11	• 305 003 232		

• Fornibile in 7 gg lavorativi / Available in 7 working days

* Fornibile anche in Acciaio Inox / Also Stainless Steel available



BSP



Filetto Thread	Nipplo a saldare Gas BSP welding Nipple	Tronchetto a saldare Gas BSP welding Adaptor	Borchia a saldare Gas BSP welding Stud	Lunghezza Length
Inch	Codice / Part. nr.	Codice / Part. nr.	Codice / Part. nr.	mm
G 1/8"-28	●* 310 000 002	● 404 201 002	●* 404 100 202	
G 1/4"-19	* 310 000 004	● 404 201 404	* 404 100 404	
G 3/8"-19	* 310 000 006	● 404 201 706	* 404 100 606	
G 1/2"-14	* 310 000 008	● 404 202 108	* 404 100 808	
G 5/8"-14	● 310 000 010	● 404 202 410	●* 404 101 010	
G 3/4"-14	* 310 000 012	● 404 202 812	* 404 101 212	
G 1"-11	* 310 000 016	● 404 203 416	* 404 101 616	
G 1.1/4"-11	* 310 000 020	●* 404 204 220	* 404 102 020	
G 1.1/2"-11	* 310 000 024	● 404 204 824	* 404 102 424	
G 2"-11	●* 310 000 032	● 404 206 032	●* 404 103 232	
G 2.1/2"-11	● 310 000 040		● 404 104 040	40
G 3"-11	● 310 000 048			

BSP



BSP



Ø Occhio Banjo Ø	Lunghezza Length	Manicotto a saldare Gas BSP welding Sleeve	Ø Occhio Banjo Ø	Tasca Socket	Occhio a saldare Gas con tasca BSP welding Banjo with socket
Inch	mm	Codice / Part. nr.	mm	mm	Codice / Part. nr.
G 1/8"-28			G 1/8"-28	6	● 201 750 206
G 1/4"-19	25	404 000 404	G 1/4"-19	8	● 201 750 408
G 3/8"-19	30	404 000 606	G 1/4"-19	10	● 201 750 410
G 1/2"-14	35	404 000 808	G 3/8"-19	10	● 201 750 610
G 5/8"-14			G 3/8"-19	12	● 201 750 612
G 3/4"-14	40	404 001 212	G 1/2"-14	15	● 201 750 815
G 1"-11	40	404 001 616	G 1/2"-14	16	● 201 750 816
G 1.1/4"-11	45	404 002 020	G 5/8"-14	18	● 201 751 018
G 1.1/2"-11	48	404 002 424	G 5/8"-14	22	● 201 751 022
G 2"-11	86	404 003 232	G 3/4"-14	20	● 201 751 220
			G 3/4"-14	22	● 201 751 222
			G 1"-11	27	● 201 751 627

● Fornibile in 7 gg lavorativi / Available in 7 working days

* Fornibile anche in Acciaio Inox / Also Stainless Steel available



METRICO



Filetto Thread	Nipplo a saldare Metrico Metric welding Nipple	Borchia a saldare Metrico Metric welding Stud
Inch	Codice / Part. nr.	Codice / Part. nr.
M 10x1	● 310 000 100	● 404 100 100
M 12x1,5	● 310 000 122	● 404 100 122
M 14x1,5	● 310 000 142	● 404 100 142
M 16x1,5	● 310 000 162	● 404 100 162
M 18x1,5	● 310 000 182	● 404 100 182
M 20x1,5	● 310 000 202	● 404 110 202
M 22x1,5	● 310 000 222	● 404 100 222
M 24x1,5	● 310 000 242	
M 26x1,5	● 310 000 262	
M 28x1,5	● 310 000 282	
M 30x1,5	● 310 000 302	

METRICO



Ø Occhio Banjo Ø	Tasca Socket	Occhio a saldare Metrico con tasca Metric welding Banjo with socket
mm	mm	Codice / Part. nr.
M 6x1	4	● 201 740 604
M 8x1	5	● 201 740 805
M 10x1	6	● 201 741 006
M 12x1,5	8	● 201 741 208
M 12x1,5	8	● 201 741 210
M 14x1,5	10	● 201 741 408
M 14x1,5	12	● 201 741 410
M 16x1,5	14	● 201 741 612
M 16x1,5	12	● 201 741 614
M 18x1,5	14	● 201 741 812
M 18x1,5	15	● 201 741 814
M 18x1,5	14	● 201 741 815
M 20x1,5	16	● 201 742 014
M 22x1,5	18	● 201 742 216
M 22x1,5	18	● 201 742 218
M 24x1,5	18	● 201 742 418
M 26x1,5	22	● 201 742 622
M 30x1,5	28	● 201 743 028

● Fornibile in 7 gg lavorativi / Available in 7 working days

**GOMITO M/M
BSP/BSPT**



Filetto Thread	Gomito 90° M/M Gas cilindrico 90° M/M BSP Elbow	Gomito 90° M.Gas/M.Gas conico 90° M.BSP/M.BSPT Elbow	Gomito 90° M/M Gas conico 90° M/M BSPT Elbow
Inch	Codice / Part. nr.	Codice / Part. nr.	Codice / Part. nr.
G 1/8"-28	● 402 000 202	402 100 202	● 402 150 202
G 1/4"-19	402 000 404	402 100 404	● 402 150 404
G 3/8"-19	402 000 606	402 100 606	● 402 150 606
G 1/2"-14	402 000 808	402 100 808	● 402 150 808
G 5/8"-14	● 402 001 010	● 402 101 010	
G 3/4"-14	● 402 001 212	402 101 212	● 402 151 212
G 1"-11	● 402 001 616	402 101 616	● 402 151 616
G 1.1/4"-11	● 402 002 020	● 402 102 020	● 402 152 020
G 1.1/2"-11	● 402 002 424	● 402 102 424	● 402 152 424

**GOMITO M/M
M/F BSP/BSPT**



Filetto Thread	Gomito 90° M.Gas/ M.Gas orientabile 90° M.BSP/M.BSP adjustable Elbow	Gomito 45° M.Gas/ M.Gas orientabile 45° M.BSP/M.BSP adjustable Elbow	Gomito 90° M.Gas conico/ F.Gas cilindrica 90° M.BSPT/F.BSP Elbow
Inch	Codice / Part. nr.	Codice / Part. nr.	Codice / Part. nr.
G 1/8"-28	● 402 700 202		● 402 800 202
G 1/4" - G 1/8"	402 700 402	●	
G 1/4"-19	402 700 404	● 402 950 404	● 402 800 404
G 3/8"-19	402 700 606	● 402 950 606	● 402 800 606
G 1/2"-14	402 700 808	● 402 950 808	● 402 800 808
G 3/4"-14	402 701 212	● 402 951 212	● 402 801 212
G 1"-11	● 402 701 616	● 402 951 616	● 402 801 616
G 1.1/4"-11	● 402 702 020	● 402 952 020	● 402 802 020
G 1.1/2"-11	● 402 702 424	402 952 424	● 402 802 424

**GOMITO M/M -
M/F BSP/NPT**



Filetto G1 G1 Thread	Filetto G2 G2 Thread	Gomito 90° M.Gas/M.NPT 90° M.BSP/M.NPT Elbow	Gomito 90° M/F NPT 90° M/F NPT Elbow	Gomito 90° F/F NPT 90° F/F NPT Elbow
Inch	Inch	Codice / Part. nr.	Codice / Part. nr.	Codice / Part. nr.
G 1/8"-28	G 1/8"-27	402 180 202	● 402 610 202	● 402 410 202
G 1/4"-19	G 1/4"-18	● 402 180 404	● 402 610 404	● 402 400 404
G 3/8"-19	G 3/8"-18	● 402 180 606	● 402 610 606	● 402 400 606
G 1/2"-14	G 1/2"-14	● 402 180 808	● 402 610 808	● 402 400 808
G 3/4"-14	G 3/4"-14	● 402 181 212	● 402 611 212	● 402 401 212
G 1"-11	G 1"-11,5	● 402 181 616	● 402 611 616	● 402 401 616
G 1.1/4"-11	G 1.1/4"-11,5	● 402 182 020	● 402 612 020	● 402 402 020
G 1.1/2"-11	G 1.1/2"-11,5		● 402 612 424	● 402 402 424

**GOMITO F/F -
M/F BSP**



Filetto Thread	Gomito 90° F/F Gas cilindrico 90° F/F BSP Elbow	Gomito 90° Fem./Fem. girevole Gas cilindrico 90° Fem./Fem.swivel BSP Elbow	Gomito 90° F.gir.Gas/ M.Gas orientabile 90° F.swiv.BSP/M.BSP adjustable Elbow
Inch	Codice / Part. nr.	Codice / Part. nr.	Codice / Part. nr.
G 1/8"-28	402 300 202	● 402 600 202	
G 1/4"-19	402 300 404	● 402 600 404	● 402 710 404
G 3/8"-19	402 300 606	● 402 600 606	● 402 710 606
G 1/2"-14	402 300 808	● 402 600 808	● 402 710 808
G 5/8"-14		● 402 601 010	
G 3/4"-14	402 301 212	● 402 601 212	● 402 711 212
G 1"-11	402 301 616	● 402 601 616	● 402 711 616
G 1.1/4"-11	● 402 302 020	● 402 602 020	● 402 712 020
G 1.1/2"-11	● 402 302 424	● 402 602 424	● 402 712 424



**GOMITO M/M
BSP/BSPT**



Filetto Thread	Gomito 90° M/Fem. girevole Gas cilindrico 90° M/Fem.swivel BSP Elbow	Gomito 90° M.conico/Fem.girevole Gas cil. 90° M.BSPT/Fem.swivel BSP Elbow	Gomito 45° M/Fem.girevole Gas cilindrico 45° M/Fem.swivel BSP Elbow
Inch	Codice / Part. nr.	Codice / Part. nr.	Codice / Part. nr.
G 1/8"-28	● 402 400 002	● 402 500 002	
G 1/4"-19	Sp 402 400 004	402 500 004	Sp ● 402 900 404
G 3/8"-19	Sp 402 400 006	402 500 006	Sp ● 402 900 606
G 1/2"-14	Sp 402 400 008	402 500 008	Sp ● 402 900 808
G 5/8"-14	Sp 402 400 010		
G 3/4"-14	Sp 402 400 012	402 500 012	Sp ● 402 901 212
G 1"-11	Sp 402 400 016	402 500 016	Sp ● 402 901 616
G 1.1/4"-11	Sp ● 402 400 020	● 402 500 020	● 402 902 020
G 1.1/2"-11	Sp ● 402 400 024	● 402 500 024	
G 2"-11	● 402 400 032		



**TEE M/M/M
BSP**



Filetto Thread	TEE M/M/M Gas cilindrico M/M/M BSP TEE	TEE M.Gas/M.Gas/M.Gas orientabile laterale M.BSP/M.BSP/M.BSP adjustable lateral TEE	TEE M.Gas/M.Gas orientabile centrale/M.Gas M.BSP/M.BSP adjustable central/M.BSP TEE
Inch	Codice / Part. nr.	Codice / Part. nr.	Codice / Part. nr.
G 1/8"-28	● 403 000 002	● 403 800 002	● 403 500 002
G 1/4"-19	403 000 004	● 403 800 004	● 403 500 004
G 3/8"-19	403 000 006	● 403 800 006	● 403 500 006
G 1/2"-14	403 000 008	● 403 800 008	● 403 500 008
G 5/8"-14	● 403 000 010		
G 3/4"-14	403 000 012	● 403 800 012	● 403 500 012
G 1"-11	403 000 016	● 403 800 016	● 403 500 016
G 1.1/4"-11	● 403 000 020	● 403 800 020	● 403 500 020
G 1.1/2"-11	● 403 000 024	● 403 800 024	● 403 500 024

ADATTATORI STAMPATI METRICI

GOMITI METRICI



Filetto Thread	Gomito 90° M/Fem.girevole Metrico 90° M/Fem. swivel Metric Elbow	Gomito 90° M/M Metrico 90° M/M Metric Elbow	Gomito 90° M.Metr./M.Metr. orientabile 90° M.Metr./M.Metr. adjustable Elbow
mm	Codice / Part. nr.	Codice / Part. nr.	Codice / Part. nr.
M 10x1		● 402 000 100	
M 12x1,5	● 402 400 122	● 402 000 122	● 402 700 122
M 14x1,5	● 402 400 142	● 402 000 142	● 402 700 142
M 16x1,5	● 402 400 162	● 402 000 162	● 402 700 162
M 18x1,5	● 402 400 182	● 402 000 182	● 402 700 182
M 20x1,5	● 402 400 202	● 402 010 202	
M 22x1,5	● 402 400 222	● 402 000 222	● 402 700 222
M 26x1,5	● 402 400 262	● 402 000 262	
M 30x1,5	● 402 400 302	● 402 000 302	

ADATTATORI STAMPATI METRICI

TEE M/M/M METRICI



Filetto Thread	TEE M/M/M Metrico M/M/M Metric TEE	TEE M.Metr./M.Metr./M.Metr. orientabile laterale M.Metr./M.Metr./M.Metr. adjustable lateral TEE	TEE M.Metr./M.Metr. orientabile centrale/M.Metr. M.Metr./M.Metr. adjustable central/M. Metr. TEE
Inch	Codice / Part. nr.	Codice / Part. nr.	Codice / Part. nr.
M 10x1	● 403 000 100		
M 12x1,5	● 403 000 122	● 403 800 122	● 403 500 122
M 14x1,5	● 403 000 142	● 403 800 142	● 403 500 142
M 16x1,5	● 403 000 162	● 403 800 162	● 403 500 162
M 18x1,5	● 403 000 182	● 403 800 182	● 403 500 182
M 20x1,5	● 403 000 202		
M 22x1,5	● 403 000 222	● 403 800 222	● 403 500 222
M 26x1,5	● 403 000 262		
M 30x1,5	● 403 000 302		



TEE BSP/BSPT



Filetto Thread	TEE M.Gas/M.Gas/ M.Gas conico laterale M.BSP/M.BSP/M.BSPT lateral TEE	TEE M.Gas/M.Gas conico centrale/M.Gas M.BSP/M.BSPT central/M.BSP TEE	TEE F.Gas/M.Gas conico centrale/F.Gas F.BSP/M.BSPT central/ F.BSP TEE
Inch	Codice / Part. nr.	Codice / Part. nr.	Codice / Part. nr.
G 1/8"-28	● 403 001 002	● 403 002 002	● 403 400 002
G 1/4"-19	● 403 001 004	● 403 002 004	● 403 400 004
G 3/8"-19	● 403 001 006	● 403 002 006	● 403 400 006
G 1/2"-14	● 403 001 008	● 403 002 008	● 403 400 008
G 5/8"-14	● 403 001 010	● 403 002 010	
G 3/4"-14	● 403 001 012	● 403 002 012	● 403 400 012
G 1"-11	● 403 001 016	● 403 002 016	● 403 400 016
G 1.1/4"-11	● 403 001 020	● 403 002 020	

TEE BSP/NPT



Filetto G1 G1 Thread	Filetto G2 G2 Thread	TEE M.Gas/M.Gas/ M.NPT laterale M.BSP/M.BSP/M.NPT lateral TEE	TEE M.Gas/M.NPT centrale/M.Gas M.BSP/M.NPT central/M.BSP TEE	TEE F/F/F NPT F/F/F NPT TEE
Inch	Inch	Codice / Part. nr.	Codice / Part. nr.	Codice / Part. nr.
G 1/8"-28	G 1/8"-27	● 403 003 002	● 403 004 002	● 403 101 002
G 1/4"-19	G 1/4"-18	● 403 003 004	● 403 004 004	● 403 101 004
G 3/8"-19	G 3/8"-18	● 403 003 006	● 403 004 006	● 403 101 006
G 1/2"-14	G 1/2"-14	● 403 003 008	● 403 004 008	● 403 101 008
G 5/8"-14	G 5/8"-14	● 403 003 010	● 403 004 010	
G 3/4"-14	G 3/4"-14	● 403 003 012	● 403 004 012	● 403 101 012
G 1"-11	G 1"-11,5	● 403 003 016	● 403 004 016	● 403 101 016
G 1.1/4"-11	G 1.1/4"-11,5	● 403 003 020	● 403 004 020	● 403 101 020
G 1.1/2"-11	G 1.1/2"-11,5			● 403 101 024



**TEE E CROCE
BSP**



Filetto Thread	TEE F/F/F Gas cilindrico F/F/F BSP TEE	Croce F/F/F/F Gas cilindrico F/F/F/F BSP Cross
Inch	Codice / Part. nr.	Codice / Part. nr.
G 1/8"-28	403 100 002	● 405 000 202
G 1/4"-19	403 100 004	405 000 404
G 3/8"-19	403 100 006	405 000 606
G 1/2"-14	403 100 008	405 000 808
G 3/4"-14	403 100 012	405 001 212
G 1"-11	403 100 016	● 405 001 616
G 1.1/4"-11	403 100 020	● 405 002 020
G 1.1/2"-11	● 403 100 024	● 405 002 424

TEE BSP



Filetto Thread	TEE Fem./Fem./Fem. girevole Gas cilindrico Fem./Fem./Fem.swivel BSP TEE	TEE M.Gas/M.Gas/ Fem. girevole Gas laterale M.BSP/M.BSP/Fem. swivel .BSP lateral TEE	TEE M.Gas/Fem. girevole Gas centrale/M.Gas M.BSP/Fem. swivel BSP central/M.BSP TEE
Inch	Codice / Part. nr.	Codice / Part. nr.	Codice / Part. nr.
G 1/8"-28	● 403 600 002	● 403 200 002	● 403 300 002
G 1/4"-19	403 600 004	403 200 004	403 300 004
G 3/8"-19	403 600 006	403 200 006	403 300 006
G 1/2"-14	403 600 008	403 200 008	403 300 008
G 3/4"-14	403 600 012	403 200 012	403 300 012
G 1"-11	403 600 016	403 200 016	403 300 016
G 1.1/4"-11	● 403 600 020	● 403 200 020	● 403 300 020
G 1.1/2"-11		● 403 200 024	● 403 300 024

TEE METRICI



Filetto Thread	TEE M. Metr./ M. Metr./ Fem. girevole Metr. laterale M. Metr./ M. Metr./ Fem. swivel .Metr. lateral TEE	TEE M. Metr./Fem. girevole Metr. centrale/ M. Metr. M. Metr./ Fem. swivel Metr. central/ M. Metr. TEE
Inch	Codice / Part. nr.	Codice / Part. nr.
M 12x1,5	● 403 200 122	● 403 300 122
M 14x1,5	● 403 200 142	● 403 300 142
M 16x1,5	● 403 200 162	● 403 300 162
M 18x1,5	● 403 200 182	● 403 300 182
M 20x1,5	● 403 200 202	● 403 300 202
M 22x1,5	● 403 200 222	● 403 300 222
M 26x1,5	● 403 200 262	● 403 300 262
M 30x1,5	● 403 200 302	● 403 300 302

ADATTATORI DI COLLEGAMENTO
CONNECTING ADAPTORS

ADATTATORI JIC 37°
JIC 37° ADAPTORS



BUSSOLA



DADO



Ø Tubo Rigido OD Tube	Bussola Metrica per tubo rigido Tube Sleeve Metric	Filetto Thread	Dado di serraggio JIC per tubo rigido Tube nut Jic
Inch	Codice / Part. nr.	Inch	Codice / Part. nr.
6	• 400 151 006	7/16"-20 UNF	• 400 151 104
8	• 400 151 008	1/2"-20 UNF	• 400 151 105
10	• 400 151 010	9/16"-18 UNF	• 400 151 106
12	• 400 151 012	3/4"-16 UNF	• 400 151 108
14	• 400 151 014	7/8"-14 UNF	• 400 151 110
18	• 400 151 018	1.1/16"-12 UN	• 400 151 112
20	• 400 151 020	1.3/16"-12 UN	• 400 151 114
25	• 400 151 025	1.5/16"-12 UN	• 400 151 116
30	• 400 151 030	1.5/8"-12 UN	• 400 151 120
32	• 400 151 032	1.7/8"-12 UN	• 400 151 124
38	• 400 151 038	2.1/2"-12 UN	• 400 151 132

BUSSOLE E DADI JIC

JIC / SAE



Filetto Thread	Nipplo M/M Jic 37° JIC 37° M/M Union	Nipplo M.Jic/M SAE M.Jic/M.SAE Union
Inch	Codice / Part. nr.	Codice / Part. nr.
7/16"-20 UNF	308 000 404	311 000 404
1/2"-20 UNF	308 000 505	311 000 505
9/16"-18 UNF	308 000 606	311 000 606
3/4"-16 UNF	308 000 808	311 000 808
7/8"-14 UNF	308 001 010	311 001 010
1.1/16"-12 UN	308 001 212	311 001 212
1.3/16"-12 UN	• 308 001 414	311 001 414
1.5/16"-12 UN	308 001 616	311 001 616
1.5/8"-12 UN	• 308 002 020	311 002 020
1.7/8"-12 UN	• 308 002 424	311 002 424
2.1/2"-12 UN	• 308 003 232	

• Fornibile in 7 gg lavorativi / Available in 7 working days



JIC / SAE



Filetto G1 G1 Thread	Filetto G2 G2 Thread	Riduzione M/M JIC 37° JIC 37° M/M Reducing	Riduzione M.JIC/M SAE M.JIC/M.SAE Reducing
Inch	Inch	Codice / Part. nr.	Codice / Part. nr.
7/16"-20 UNF	1/2"-20 UNF	•	311 000 405
7/16"-20 UNF	9/16"-18 UNF	•	311 000 406
7/16"-20 UNF	3/4"-16 UNF	•	311 000 408
1/2"-20 UNF	9/16"-18 UNF	•	311 000 506
1/2"-20 UNF	7/8"-14 UNF	•	311 000 510
9/16"-18 UNF	7/16"-20 UNF	•	311 000 604
9/16"-18 UNF	1/2"-20 UNF	•	311 000 605
9/16"-18 UNF	3/4"-16 UNF	•	311 000 608
9/16"-18 UNF	7/8"-14 UNF	•	311 000 610
3/4"-16 UNF	9/16"-18 UNF	•	311 000 806
3/4"-16 UNF	7/8"-14 UNF	•	311 000 810
3/4"-16 UNF	1.1/16"-12 UN	•	311 000 812
7/8"-14 UNF	3/4"-16 UNF	•	311 001 008
7/8"-14 UNF	1.1/16"-12 UN	•	311 001 012
1.1/16"-12 UN	3/4"-16 UNF	•	311 001 208
1.1/16"-12 UN	7/8"-14 UNF	•	311 001 210
1.1/16"-12 UN	1.5/16"-12 UN	•	311 001 216
1.3/16"-12 UN	1.5/16"-12 UN	•	308 001 416
1.5/16"-12 UN	7/8"-14 UNF	•	311 001 610
1.5/16"-12 UN	1.1/16"-12 UN	•	311 001 612
1.5/16"-12 UN	1.5/8"-12 UN	•	311 001 620
1.5/8"-12 UN	1.5/16"-12 UN	•	311 002 016
1.7/8"-12 UN	1.5/8"-12 UN	•	311 002 420

• Fornibile in 7 gg lavorativi / Available in 7 working days



NIPPLI M/M JIC / BSP / BSPT



Filetto G1 G1 Thread	Filetto G2 G2 Thread	Nipplo M.JIC/M.Gas svasato M.Jic/M.BSP cone 60° Union	Nipplo M.JIC/M.Gas piano con o-ring M.Jic/M.BSP flat o-ring Union	Nipplo M.JIC/M.Gas conico M.Jic/M.BSPT Union
Inch	Inch	Codice / Part. nr.	Codice / Part. nr.	Codice / Part. nr.
7/16"-20 UNF	G 1/8"-28	319 000 402	318 000 402	327 000 402
7/16"-20 UNF	G 1/4"-19	319 000 404	318 000 404	327 000 404
7/16"-20 UNF	G 3/8"-19	319 000 406	318 000 406	
7/16"-20 UNF	G 1/2"-14	319 000 408	318 000 408	
1/2"-20 UNF	G 1/8"-28			327 000 502
1/2"-20 UNF	G 1/4"-19	319 000 504	318 000 504	327 000 504
1/2"-20 UNF	G 3/8"-19	319 000 506	318 000 506	
9/16"-18 UNF	G 1/4"-19	319 000 604	318 000 604	327 000 604
9/16"-18 UNF	G 3/8"-19	319 000 606	318 000 606	327 000 606
9/16"-18 UNF	G 1/2"-14	319 000 608	318 000 608	327 000 608
3/4"-16 UNF	G 1/4"-19	319 000 804	318 000 804	327 000 804
3/4"-16 UNF	G 3/8"-19	319 000 806	318 000 806	327 000 806
3/4"-16 UNF	G 1/2"-14	319 000 808	318 000 808	327 000 808
3/4"-16 UNF	G 3/4"-14	319 000 812	318 000 812	327 000 812
7/8"-14 UNF	G 3/8"-19	319 001 006	318 001 006	327 001 006
7/8"-14 UNF	G 1/2"-14	319 001 008	318 001 008	327 001 008
7/8"-14 UNF	G 3/4"-14	319 001 012	318 001 012	327 001 012
7/8"-14 UNF	G 1"-11	319 001 016		
1.1/16"-12 UN	G 1/2"-14	319 001 208	318 001 208	327 001 208
1.1/16"-12 UN	G 3/4"-14	319 001 212	318 001 212	327 001 212
1.1/16"-12 UN	G 1"-11	319 001 216	318 001 216	327 001 216
1.5/16"-12 UN	G 3/4"-14	319 001 612	318 001 612	327 001 612
1.5/16"-12 UN	G 1"-11	319 001 616	318 001 616	327 001 616
1.5/16"-12 UN	G 1.1/4"-11	319 001 620	318 001 620	
1.5/8"-12 UN	G 1"-11	319 002 016	318 002 016	327 002 016
1.5/8"-12 UN	G 1.1/4"-11	319 002 020	318 002 020	327 002 020
1.7/8"-12 UN	G 1.1/4"-11	319 002 420	318 002 420	327 002 420
1.7/8"-12 UN	G 1.1/2"-11	319 002 424	318 002 424	327 002 424

● Fornibile in 7 gg lavorativi / Available in 7 working days

JIC / NPT



Filetto G1 G1 Thread	Filetto G2 G2 Thread	Nipplo M.JIC/M.NPT M.Jic/M.NPT Union
Inch	Inch	Codice / Part. nr.
7/16"-20 UNF	G 1/8"-27	336 000 402
7/16"-20 UNF	G 1/4"-18	336 000 404
7/16"-20 UNF	G 3/8"-18	336 000 406
7/16"-20 UNF	G 1/2"-14	336 000 408
1/2"-20 UNF	G 1/8"-27	336 000 502
1/2"-20 UNF	G 1/4"-18	336 000 504
1/2"-20 UNF	G 3/8"-18	336 000 506
9/16"-18 UNF	G 1/8"-27	336 000 602
9/16"-18 UNF	G 1/4"-18	336 000 604
9/16"-18 UNF	G 3/8"-18	336 000 606
9/16"-18 UNF	G 1/2"-14	336 000 608
3/4"-16 UNF	G 1/4"-18	336 000 804
3/4"-16 UNF	G 3/8"-18	336 000 806
3/4"-16 UNF	G 1/2"-14	336 000 808
3/4"-16 UNF	G 3/4"-14	336 000 812
7/8"-14 UNF	G 3/8"-18	336 001 006
7/8"-14 UNF	G 1/2"-14	336 001 008
7/8"-14 UNF	G 3/4"-14	336 001 012
7/8"-14 UNF	G 1"-11,5	336 001 016
1.1/16"-12 UN	G 1/2"-14	336 001 208
1.1/16"-12 UN	G 3/4"-14	336 001 212
1.1/16"-12 UN	G 1"-11,5	336 001 216
1.5/16"-12 UN	G 3/4"-14	336 001 612
1.5/16"-12 UN	G 1"-11,5	336 001 616
1.5/16"-12 UN	G 1.1/4"-11,5	336 001 620
1.5/8"-12 UN	G 1"-11,5	336 002 016
1.5/8"-12 UN	G 1.1/4"-11,5	336 002 020
1.7/8"-12 UN	G 1.1/4"-11,5	336 002 420
1.7/8"-12 UN	G 1.1/2"-11,5	336 002 424

● Fornibile in 7 gg lavorativi / Available in 7 working days



JIC / METRICO

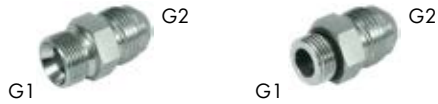

Filetto G1 G1 Thread	Filetto G2 G2 Thread	Nipplo M.JIC/M. Metric svasato M.Jic/M.Metric cone 60° Union	Nipplo M.JIC/M.Metrico piano con o-ring M.Jic/M.Metric flat o-ring Union
Inch	mm	Codice / Part. nr.	Codice / Part. nr.
7/16"-20 UNF	M 10x1	• 329 004 100	• 328 004 100
7/16"-20 UNF	M 12x1,5	• 329 004 122	• 328 004 122
7/16"-20 UNF	M 14x1,5	• 329 004 142	• 328 004 142
1/2"-20 UNF	M 10x1	• 329 005 100	• 328 005 100
1/2"-20 UNF	M 12x1,5	• 329 005 122	• 328 005 122
1/2"-20 UNF	M 14x1,5	• 329 005 142	• 328 005 142
9/16"-18 UNF	M 14x1,5	• 329 006 142	• 328 006 142
9/16"-18 UNF	M 16x1,5	• 329 006 162	• 328 006 162
3/4"-16 UNF	M 16x1,5	• 329 008 162	• 328 008 162
3/4"-16 UNF	M 18x1,5	• 329 008 182	• 328 008 182
3/4"-16 UNF	M 22x1,5	• 329 008 222	• 328 008 222
7/8"-14 UNF	M 18x1,5	• 329 010 182	• 328 010 182
7/8"-14 UNF	M 20x1,5	• 329 010 222	• 328 010 202
7/8"-14 UNF	M 22x1,5	• 329 010 222	• 328 010 222
1.1/16"-12 UN	M 22x1,5	• 329 012 222	• 328 012 222
1.1/16"-12 UN	M 27x23	• 329 012 222	• 328 012 273
1.5/16"-12 UN	M 27x2	• 329 016 273	• 328 016 273
1.5/16"-12 UN	M 33x2	• 329 016 333	• 328 016 333
1.5/8"-12 UN	M 42x2	• 329 020 423	• 328 020 423
1.7/8"-12 UN	M 48x2	• 329 024 483	• 328 024 483

• Fornibile in 7 gg lavorativi / Available in 7 working days



JIC / BSP



Filetto G1 G1 Thread	Filetto G2 G2 Thread	Adattatore M.JIC/Femmina Fissa Gas M.Jic/Female BSP Adaptor	Filetto G1 G1 Thread	Adattatore M.JIC/Femmina Fissa NPT M.Jic/Female NPT Adaptor
Inch	Inch	Codice / Part. nr.	Inch	Codice / Part. nr.
7/16"-20 UNF	G 1/8"-28	• 324 000 402	G 1/8"-27	• 337 000 402
7/16"-20 UNF	G 1/4"-19	• 324 000 404	G 1/4"-18	• 337 000 404
1/2"-20 UNF	G 1/8"-28	• 324 000 502	G 1/8"-27	• 337 000 502
1/2"-20 UNF	G 1/4"-19	• 324 000 504	G 1/4"-18	• 337 000 504
9/16"-18 UNF	G 1/4"-19	• 324 000 604	G 1/4"-18	• 337 000 604
9/16"-18 UNF	G 3/8"-19	• 324 000 606	G 3/8"-18	• 337 000 606
3/4"-16 UNF	G 1/4"-19	• 324 000 804	G 1/4"-18	• 337 000 804
3/4"-16 UNF	G 3/8"-19	• 324 000 806	G 3/8"-18	• 337 000 806
3/4"-16 UNF	G 1/2"-14	• 324 000 808	G 1/2"-14	• 337 000 808
7/8"-14 UNF	G 1/2"-14	• 324 001 008	G 1/2"-14	• 337 001 008
1.1/16"-12 UN	G 1/2"-14	• 324 001 208	G 1/2"-14	• 337 001 208
1.1/16"-12 UN	G 3/4"-14	• 324 001 212	G 3/4"-14	• 337 001 212
1.5/16"-12 UN	G 1"-11	• 324 001 616	G 1"-11,5	• 337 001 616
1.5/8"-12 UN	G 1"-11	• 324 002 016		
1.5/8"-12 UN	G 1.1/4"-11	• 324 002 020	G 1.1/4"-11,5	• 337 002 020
1.7/8"-12 UN	G 1.1/2"-11	• 324 002 424	G 1.1/2"-11,5	• 337 002 424

• Fornibile in 7 gg lavorativi / Available in 7 working days

ADATTATORI CON F.GIREVOLE JIC



ADATTATORI M.BSP/F.GIREVOLE JIC

JIC



Filetto Thread	Adattatore M./Fem. girevole JIC 37° M./Fem.swivel JIC 37° Adaptors	Adattatore Fem./Fem. girevole JIC 37° Fem./Fem.swivel JIC 37° Adaptors
Inch	Codice / Part. nr.	Codice / Part. nr.
7/16"-20 UNF	● 308 100 404	● 308 400 404
1/2"-20 UNF	● 308 100 505	● 308 400 505
9/16"-18 UNF	● 308 100 606	● 308 400 606
3/4"-16 UNF	● 308 100 808	● 308 400 808
7/8"-14 UNF	● 308 101 010	● 308 401 010
1.1/16"-12 UN	● 308 101 212	● 308 401 212
1.3/16"-12 UN	● 308 101 414	● 308 401 414
1.5/16"-12 UN	● 308 101 616	
1.5/8"-12 UN	● 308 102 020	
1.7/8"-12 UN	● 308 102 424	
2.1/2"-12 UN	● 308 103 232	

JIC / BSP



Filetto G1 G1 Thread	Filetto G2 G2 Thread	Adattatore F.gir.JIC/ M Gas Fem.swivel Jic/ Male BSP Adaptor
Inch	Inch	Codice / Part. nr.
7/16"-20 UNF	G 1/8"-28	● 325 000 402
7/16"-20 UNF	G 1/4"-19	● 325 000 404
7/16"-20 UNF	G 3/8"-19	● 325 000 406
1/2"-20 UNF	G 1/8"-28	● 325 000 502
1/2"-20 UNF	G 1/4"-19	● 325 000 504
1/2"-20 UNF	G 3/8"-19	● 325 000 506
9/16"-18 UNF	G 1/4"-19	● 325 000 604
9/16"-18 UNF	G 3/8"-19	● 325 000 606
9/16"-18 UNF	G 1/2"-14	● 325 000 608
3/4"-16 UNF	G 1/4"-19	● 325 000 804
3/4"-16 UNF	G 3/8"-19	● 325 000 806
3/4"-16 UNF	G 1/2"-14	● 325 000 808
3/4"-16 UNF	G 3/4"-14	● 325 000 812
7/8"-14 UNF	G 3/8"-19	● 325 001 006
7/8"-14 UNF	G 1/2"-14	● 325 001 008
7/8"-14 UNF	G 3/4"-14	● 325 001 012
1.1/16"-12 UN	G 1/2"-14	● 325 001 208
1.1/16"-12 UN	G 3/4"-14	● 325 001 212
1.1/16"-12 UN	G 1"-11	● 325 001 216
1.5/16"-12 UN	G 3/4"-14	● 325 001 612
1.5/16"-12 UN	G 1"-11	● 325 001 616
1.5/16"-12 UN	G 1.1/4"-11	● 325 001 620
1.5/8"-12 UN	G 1"-11	● 325 002 016
1.5/8"-12 UN	G 1.1/4"-11	● 325 002 020
1.7/8"-12 UN	G 1.1/4"-11	● 325 002 420
1.7/8"-12 UN	G 1.1/2"-11	● 325 002 424

ADATTATORI M./F.GIREVOLE JIC / SAE

RIDUZIONE M./Fg. JIC



ADATTATORE Fg. JIC / M. SAE



Filetto G1 G1 Thread	Filetto G2 G2 Thread	Riduzione M./Fem. girevole JIC 37° M.SAE/Fem.swivel JIC 37° Reducing	Filetto Thread	Adattatore M.SAE/ Fem. girevole JIC 37° M.SAE/Fem.swivel JIC 37° Adaptors
Inch	Inch	Codice / Part. nr.	Inch	Codice / Part. nr.
7/16"-20 UNF	9/16"-18 UNF	308 100 406	7/16"-20 UNF	● 314 000 404
7/16"-20 UNF	3/4"-16 UNF	308 100 408	1/2"-20 UNF	● 314 000 505
7/16"-20 UNF	7/8"-14 UNF	308 100 410	9/16"-18 UNF	● 314 000 606
9/16"-18 UNF	3/4"-16 UNF	308 100 608	3/4"-16 UNF	● 314 000 808
9/16"-18 UNF	7/8"-14 UNF	308 100 610	7/8"-14 UNF	● 314 001 010
9/16"-18 UNF	1.1/16"-12 UN	308 100 612	1.1/16"-12 UN	● 314 001 212
3/4"-16 UNF	7/8"-14 UNF	308 100 810	1.3/16"-12 UN	● 314 001 414
3/4"-16 UNF	1.1/16"-12 UN	308 100 812	1.5/16"-12 UN	● 314 001 616
7/8"-14 UNF	1.1/16"-12 UN	308 101 012	1.5/8"-12 UN	● 314 002 020
1.1/16"-12 UN	1.5/16"-12 UN	308 101 216	1.7/8"-12 UN	● 314 002 424

ADATTATORI JIC 37° JIC 37° ADAPTORS

TAPPI JIC / SAE



JIC / SAE



Filetto Thread	Tappo Femmina Jic 37° JIC 37° Female Plug	Tappo Maschio Jic 37° JIC 37° Male Plug	Tappo Maschio SAE SAE Male Plug
Inch	Codice / Part. nr.	Codice / Part. nr.	Codice / Part. nr.
7/16"-20 UNF	400 051 104	400 051 004	317 700 404
1/2"-20 UNF	400 051 105	400 051 005	317 700 505
9/16"-18 UNF	400 051 106	400 051 006	317 700 606
3/4"-16 UNF	400 051 108	400 051 008	317 700 808
7/8"-14 UNF	400 051 110	400 051 010	317 701 010
1.1/16"-12 UN	400 051 112	400 051 012	317 701 212
1.3/16"-12 UN	400 051 114	400 051 014	317 701 414
1.5/16"-12 UN	400 051 116	400 051 016	317 701 616
1.5/8"-12 UN	400 051 120	400 051 020	317 702 020
1.7/8"-12 UN	400 051 124	400 051 024	

PASSAPARETE JIC

JIC



Filetto Thread	Passaparete JIC 37° completo di dado JIC 37° Bulkhead nut completed	Passaparete 90° JIC 37° completo di dado 90° JIC 37° Bulkhead nut completed
Inch	Codice / Part. nr.	Codice / Part. nr.
7/16"-20 UNF	305 100 404	490 300 404
1/2"-20 UNF	305 100 505	490 300 505
9/16"-18 UNF	305 100 606	490 300 606
3/4"-16 UNF	305 100 808	490 300 808
7/8"-14 UNF	305 101 010	490 301 010
1.1/16"-12 UN	305 101 212	490 301 212
1.3/16"-12 UN	305 101 414	490 301 414
1.5/16"-12 UN	305 101 616	490 301 616
1.5/8"-12 UN	305 102 020	490 302 020
1.7/8"-12 UN	305 102 424	490 302 424

● Fornibile in 7 gg lavorativi / Available in 7 working days

ADATTATORI JIC 37° JIC 37° ADAPTORS

ADATTATORI STAMPATI JIC / SAE



GOMITO M/M JIC / SAE



Filetto Thread	Gomito 90° M./M. JIC 37° 90° M./M.JIC 37° Elbow	Gomito 90° M.JIC/ M.SAE orientabile 90° M.JIC/M.SAE adjustable Elbow	Gomito 45° M.JIC/ M.SAE orientabile 45° M.JIC/M.SAE adjustable Elbow
Inch	Codice / Part. nr.	Codice / Part. nr.	Codice / Part. nr.
7/16"-20 UNF	490 200 404	313 000 404	312 000 404
1/2"-20 UNF	490 200 505	313 000 505	312 000 505
9/16"-18 UNF	490 200 606	313 000 606	312 000 606
3/4"-16 UNF	490 200 808	313 000 808	312 000 808
7/8"-14 UNF	490 201 010	313 001 010	312 001 010
1.1/16"-12 UN	490 201 212	313 001 212	312 001 212
1.3/16"-12 UN	490 201 414		
1.5/16"-12 UN	490 201 616	313 001 616	312 001 616
1.5/8"-12 UN	490 202 020	313 002 020	312 002 020
1.7/8"-12 UN	490 202 424	313 002 424	312 002 424

ADATTATORI STAMPATI JIC

JIC



Filetto Thread	Gomito 90° M/Fem. girevole JIC 37° 90° M/Fem.swivel JIC 37° Elbow	Gomito 45° M/Fem. girevole JIC 37° 45° M/Fem.swivel JIC 37° Elbow
Inch	Codice / Part. nr.	Codice / Part. nr.
7/16"-20 UNF	308 300 404	308 200 404
1/2"-20 UNF	308 300 505	308 200 505
9/16"-18 UNF	308 300 606	308 200 606
3/4"-16 UNF	308 300 808	308 200 808
7/8"-14 UNF	308 301 010	308 201 010
1.1/16"-12 UN	308 301 212	308 201 212
1.3/16"-12 UN	308 301 414	308 201 414
1.5/16"-12 UN	308 301 616	308 201 616
1.5/8"-12 UN	308 302 020	308 202 020
1.7/8"-12 UN	308 302 424	308 202 424
2.1/2"-12 UN		

● Fornibile in 7 gg lavorativi / Available in 7 working days



**GOMITO RIDOTTO
M/M JIC / SAE**

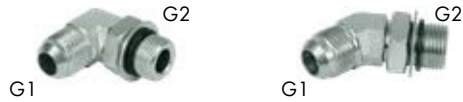

Filetto G1 G1 Thread	Filetto G2 G2 Thread	Gomito Rid. 90° M.JIC/ M.SAE orientabile 90° M.JIC/M.SAE adjustable Elbow Red.	Gomito Rid. 45° M.JIC/ M.SAE orientabile 45° M.JIC/M.SAE adjustable Elbow Red.
Inch	Inch	Codice / Part. nr.	Codice / Part. nr.
7/16"-20 UNF	1/2"-20 UNF	• 313 000 405	• 312 000 405
7/16"-20 UNF	9/16"-18 UNF	• 313 000 406	
1/2"-20 UNF	9/16"-18 UNF	• 313 000 506	
9/16"-18 UNF	7/16"-20 UNF	• 313 000 604	
9/16"-18 UNF	1/2"-20 UNF	• 313 000 605	
9/16"-18 UNF	3/4"-16 UNF	• 313 000 608	• 312 000 608
3/4"-16 UNF	9/16"-18 UNF	• 313 000 806	
3/4"-16 UNF	7/8"-14 UNF	• 313 000 810	• 312 000 810
3/4"-16 UNF	1.1/16"-12 UN	• 313 000 812	
7/8"-14 UNF	3/4"-16 UNF	• 313 001 008	• 312 001 008
7/8"-14 UNF	1.1/16"-12 UN	• 313 001 012	
1.1/16"-12 UN	3/4"-16 UNF	• 313 001 208	• 312 001 208
1.1/16"-12 UN	7/8"-14 UNF	• 313 001 210	• 302 001 210
1.1/16"-12 UN	1.5/16"-12 UN	• 313 001 216	• 302 001 216
1.5/16"-12 UN	1.1/16"-12 UN	• 313 001 612	• 302 001 612
1.5/16"-12 UN	1.5/8"-12 UN	• 313 001 620	• 312 001 620

• Fornibile in 7 gg lavorativi / Available in 7 working days



**GOMITO M/M
JIC / BSP / BSPT**



Filetto G1 G1 Thread	Filetto G2 G2 Thread	Gomito 90° M.JIC/ M.BSP orientabile 90° M.JIC/M.BSP adjustable Elbow	Gomito 45° M.JIC/ M.BSP orientabile 45° M.JIC/M.BSP adjustable Elbow	Gomito 90° M.JIC/ M.Gas conico 90° M.JIC/M.BSPT Elbow
Inch	Inch	Codice / Part. nr.	Codice / Part. nr.	Codice / Part. nr.
7/16"-20 UNF	G 1/8"-28	• 320 000 402		• 326 000 402
7/16"-20 UNF	G 1/4"-19	• 320 000 404	• 321 000 404	• 326 000 404
7/16"-20 UNF	G 3/8"-19	• 320 000 406		
7/16"-20 UNF	G 1/2"-14	• 320 000 408		
1/2"-20 UNF	G 1/8"-28	• 320 000 502		• 326 000 502
1/2"-20 UNF	G 1/4"-19	• 320 000 504	• 321 000 504	• 326 000 504
1/2"-20 UNF	G 3/8"-19	• 320 000 506		
9/16"-18 UNF	G 1/4"-19	• 320 000 604	• 321 000 604	• 326 000 604
9/16"-18 UNF	G 3/8"-19	• 320 000 606		• 326 000 606
9/16"-18 UNF	G 1/2"-14	• 320 000 608		• 326 000 608
3/4"-16 UNF	G 1/4"-19	• 320 000 804		• 326 000 804
3/4"-16 UNF	G 3/8"-19	• 320 000 806	• 321 000 806	• 326 000 806
3/4"-16 UNF	G 1/2"-14	• 320 000 808	• 321 000 808	• 326 000 808
3/4"-16 UNF	G 3/4"-14	• 320 000 812		• 326 000 812
7/8"-14 UNF	G 3/8"-19	• 320 001 006		• 326 001 006
7/8"-14 UNF	G 1/2"-14	• 320 001 008	• 321 001 008	• 326 001 008
7/8"-14 UNF	G 3/4"-14	• 320 001 012		• 326 001 012
1.1/16"-12 UN	G 1/2"-14	• 320 001 208	• 321 001 208	• 326 001 208
1.1/16"-12 UN	G 3/4"-14	• 320 001 212	• 321 001 212	• 326 001 212
1.1/16"-12 UN	G 1"-11	• 320 001 216		• 326 001 216
1.5/16"-12 UN	G 3/4"-14	• 320 001 612		• 326 001 612
1.5/16"-12 UN	G 1"-11	• 320 001 616	• 321 001 616	• 326 001 616
1.5/16"-12 UN	G 1.1/4"-11	• 320 001 620		
1.5/8"-12 UN	G 1"-11	• 320 002 016		• 326 002 016
1.5/8"-12 UN	G 1.1/4"-11	• 320 002 020	• 321 002 020	• 326 002 020
1.7/8"-12 UN	G 1.1/4"-11	• 320 002 420		
1.7/8"-12 UN	G 1.1/2"-11	• 320 002 424	• 321 002 424	• 326 002 424

• Fornibile in 7 gg lavorativi / Available in 7 working days



**GOMITO M/M
JIC / METRICO**

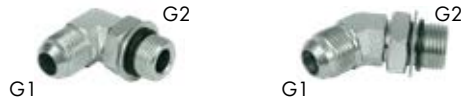

Filetto G1 G1 Thread	Filetto G2 G2 Thread	Gomito 90° M.JIC/ M.Metrico orientabile 90° M.JIC/M.Metric adjustable Elbow	Gomito 45° M.JIC/ M.Metrico orientabile 45° M.JIC/M.Metric adjustable Elbow
Inch	mm	Codice / Part. nr.	Codice / Part. nr.
7/16"-20 UNF	M 10x1	• 330 004 100	
7/16"-20 UNF	M 12x1,5	• 330 004 122	
1/2"-20 UNF	M 10x1	• 330 005 100	331 005 100
1/2"-20 UNF	M 12x1,5	• 330 005 122	
1/2"-20 UNF	M 14x1,5	• 330 005 142	
9/16"-18 UNF	M 14x1,5	• 330 006 142	331 006 142
9/16"-18 UNF	M 16x1,5	• 330 006 162	
3/4"-16 UNF	M 16x1,5	• 330 008 162	331 008 162
3/4"-16 UNF	M 18x1,5	• 330 008 182	331 008 182
7/8"-14 UNF	M 18x1,5	• 330 010 182	331 010 182
7/8"-14 UNF	M 22x1,5	• 330 010 222	331 010 222
1.1/16"-12 UN	M 22x1,5	• 330 012 222	331 012 222
1.5/16"-12 UN	M 27x2	• 330 016 273	
1.5/16"-12 UN	M 33x2	• 330 016 333	331 016 333
1.5/8"-12 UN	M 42x2	• 330 020 423	
1.7/8"-12 UN	M 48x2	• 330 024 483	

• Fornibile in 7 gg lavorativi / Available in 7 working days



**GOMITO M/M
JIC / NPT**



Filetto G1 G1 Thread	Filetto G2 G2 Thread	Gomito 90° M.JIC/M.NPT 90° M.JIC/M.NPT Elbow	Gomito 45° M.JIC/ M.NPT 45° M.JIC/M.NPT Elbow	Gomito 90° M.JIC/F.NPT 90° M.JIC/F.NPT Elbow
Inch	Inch	Codice / Part. nr.	Codice / Part. nr.	Codice / Part. nr.
7/16"-20 UNF	G 1/8"-27	• 338 000 402	• 339 000 402	• 342 000 402
7/16"-20 UNF	G 1/4"-18	• 338 000 404	• 339 000 404	• 342 000 404
1/2"-20 UNF	G 1/8"-27	• 338 000 502	• 339 000 502	• 342 000 502
1/2"-20 UNF	G 1/4"-18	• 338 000 504	• 339 000 504	• 342 000 504
9/16"-18 UNF	G 1/8"-27	• 338 000 602	• 339 000 602	• 342 000 602
9/16"-18 UNF	G 1/4"-18	• 338 000 604	• 339 000 604	• 342 000 604
9/16"-18 UNF	G 3/8"-18	• 338 000 606	• 339 000 606	• 342 000 606
9/16"-18 UNF	G 1/2"-14	• 338 000 608	• 339 000 608	
3/4"-16 UNF	G 1/4"-18	• 338 000 804	• 339 000 804	• 342 000 804
3/4"-16 UNF	G 3/8"-18	• 338 000 806	• 339 000 806	• 342 000 806
3/4"-16 UNF	G 1/2"-14	• 338 000 808	• 339 000 808	
3/4"-16 UNF	G 3/4"-14	• 338 000 812	• 339 000 812	
7/8"-14 UNF	G 3/8"-18	• 338 001 006	• 339 001 006	
7/8"-14 UNF	G 1/2"-14	• 338 001 008	• 339 001 008	• 342 001 008
7/8"-14 UNF	G 3/4"-14	• 338 001 012	• 339 001 012	
1.1/16"-12 UN	G 1/2"-14	• 338 001 208	• 339 001 208	• 342 001 208
1.1/16"-12 UN	G 3/4"-14	• 338 001 212	• 339 001 212	• 342 001 212
1.5/16"-12 UN	G 3/4"-14	• 338 001 612	• 339 001 612	
1.5/16"-12 UN	G 1"-11,5	• 338 001 616	• 339 001 616	• 342 001 616
1.5/8"-12 UN	G 1"-11,5	• 338 002 016	• 339 002 016	
1.5/8"-12 UN	G 1.1/4"-11,5	• 338 002 020	• 339 002 020	• 342 002 020
1.7/8"-12 UN	G 1.1/4"-11,5	• 338 002 420		
1.7/8"-12 UN	G 1.1/2"-11,5	• 338 002 424	• 339 002 424	

• Fornibile in 7 gg lavorativi / Available in 7 working days

ADATTATORI STAMPATI JIC / SAE



**TEE M/M/M
JIC / SAE**



Filetto Thread	TEE M./M./M. JIC 37° M./M./M.JIC 37° TEE	TEE M.JIC/M.JIC/ M.SAE orientabile laterale M.JIC/M.JIC/M.SAE adjustable lateral TEE	TEE M.JIC/M.SAE orientabile centrale/M.JIC M.JIC/M.SAE adjustable central/M. JIC TEE
Inch	Codice / Part. nr.	Codice / Part. nr.	Codice / Part. nr.
7/16"-20 UNF	308 500 404	316 600 404	315 500 404
1/2"-20 UNF	308 500 505	316 600 505	315 500 505
9/16"-18 UNF	308 500 606	316 600 606	315 500 606
3/4"-16 UNF	308 500 808	316 600 808	315 500 808
7/8"-14 UNF	308 501 010	316 601 010	315 501 010
1.1/16"-12 UN	308 501 212	316 601 212	315 501 212
1.3/16"-12 UN	308 501 414		
1.5/16"-12 UN	308 501 616	316 601 616	315 501 616
1.5/8"-12 UN	308 502 020	316 602 020	315 502 020
1.7/8"-12 UN	308 502 424	316 602 424	315 502 424

ADATTATORI STAMPATI JIC

**TEE M/FEM.
GIREVOLE JIC**



Filetto Thread	TEE M./M./F.girevole laterale JIC 37° JIC 37° M./M./F.swivel lateral TEE	TEE M./F.girevole centrale/M. JIC 37° JIC 37° M./F.swivel central/M. TEE
Inch	Codice / Part. nr.	Codice / Part. nr.
7/16"-20 UNF	308 600 404	308 700 404
1/2"-20 UNF	308 600 505	308 700 505
9/16"-18 UNF	308 600 606	308 700 606
3/4"-16 UNF	308 600 808	308 700 808
7/8"-14 UNF	308 601 010	308 701 010
1.1/16"-12 UN	308 601 212	308 701 212
1.3/16"-12 UN	308 601 414	308 701 414
1.5/16"-12 UN	308 601 616	308 701 616
1.5/8"-12 UN	308 602 020	308 702 020

ADATTATORI STAMPATI JIC / BSP



**TEE M/M/M
JIC / BSP**



Filetto G1 G1 Thread	Filetto G2 G2 Thread	TEE M.JIC/M.JIC/ M.Gas orientabile laterale M.JIC/M.JIC/M.BSP adjustable lateralTEE	TEE M.JIC/M.Gas orientabile centrale/M.JIC M.JIC/M.BSP adjustable central/M. JIC TEE
Inch	Inch	Codice / Part. nr.	Codice / Part. nr.
7/16"-20 UNF	G 1/8"-28	323 000 402	322 000 402
7/16"-20 UNF	G 1/4"-19	323 000 404	322 000 404
7/16"-20 UNF	G 3/8"-19	323 000 406	322 000 406
7/16"-20 UNF	G 1/2"-14	323 000 408	322 000 408
1/2"-20 UNF	G 1/8"-28	323 000 502	322 000 502
1/2"-20 UNF	G 1/4"-19	323 000 504	322 000 504
1/2"-20 UNF	G 3/8"-19	323 000 506	322 000 506
9/16"-18 UNF	G 1/4"-19	323 000 604	322 000 604
9/16"-18 UNF	G 3/8"-19	323 000 606	322 000 606
9/16"-18 UNF	G 1/2"-14	323 000 608	322 000 608
3/4"-16 UNF	G 1/4"-19	323 000 804	322 000 804
3/4"-16 UNF	G 3/8"-19	323 000 806	322 000 806
3/4"-16 UNF	G 1/2"-14	323 000 808	322 000 808
3/4"-16 UNF	G 3/4"-14	323 000 812	322 000 812
7/8"-14 UNF	G 3/8"-19	323 001 006	322 001 006
7/8"-14 UNF	G 1/2"-14	323 001 008	322 001 008
7/8"-14 UNF	G 3/4"-14	323 001 012	322 001 012
1.1/16"-12 UN	G 1/2"-14	323 001 208	322 001 208
1.1/16"-12 UN	G 3/4"-14	323 001 212	322 001 212
1.1/16"-12 UN	G 1"-11	323 001 216	322 001 216
1.5/16"-12 UN	G 3/4"-14	323 001 612	322 001 612
1.5/16"-12 UN	G 1"-11	323 001 616	322 001 616
1.5/16"-12 UN	G 1.1/4"-11	323 001 620	322 001 620
1.5/8"-12 UN	G 1"-11	323 002 016	322 002 016
1.5/8"-12 UN	G 1.1/4"-11	323 002 020	322 002 020
1.7/8"-12 UN	G 1.1/4"-11	323 002 420	322 002 420
1.7/8"-12 UN	G 1.1/2"-11	323 002 424	322 002 424



**TEE M/M/M
JIC / METRICO**

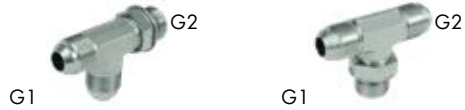

Filetto G1 G1 Thread	Filetto G2 G2 Thread	TEE M.JIC/M.JIC/ M.Metrico orientabile laterale M.JIC/M.JIC/M.Metric adjustable lateral TEE	TEE M.JIC/M.Metrico orientabile centrale/M.JIC M.JIC/M.Metric adjustable central/M. JIC TEE
Inch	mm	Codice / Part. nr.	Codice / Part. nr.
7/16"-20 UNF	M 10x1	● 333 004 100	● 332 004 100
1/2"-20 UNF	M 12x1,5	● 333 005 122	● 332 005 122
9/16"-18 UNF	M 14x1,5	● 333 006 142	● 332 006 142
3/4"-16 UNF	M 16x1,5	● 333 008 162	● 332 008 162
3/4"-16 UNF	M 18x1,5	● 333 008 182	● 332 008 182
7/8"-14 UNF	M 18x1,5	● 333 010 182	● 332 010 182
7/8"-14 UNF	M 20x1,5	● 333 010 202	● 332 010 202
7/8"-14 UNF	M 22x1,5	● 333 010 222	● 332 010 222
1.1/16"-12 UN	M 22x1,5	● 333 012 222	● 332 012 222
1.1/16"-12 UN	M 27x2	● 333 012 273	● 332 012 273



**TEE M/M/M
JIC / NPT**



Filetto G1 G1 Thread	Filetto G2 G2 Thread	TEE M.JIC/M.JIC/ M.NPT laterale M.JIC/M.JIC/M.NPT lateral TEE	TEE M.JIC/M.NPT centrale/M.JIC M.JIC/M.NPT central/ M.JIC TEE
Inch	mm	Codice / Part. nr.	Codice / Part. nr.
7/16"-20 UNF	G 1/8"-27	● 341 000 402	● 340 000 402
7/16"-20 UNF	G 1/4"-18	● 341 000 404	● 340 000 404
1/2"-20 UNF	G 1/8"-27	● 341 000 502	● 340 000 502
1/2"-20 UNF	G 3/8"-18	● 341 000 506	● 340 000 506
9/16"-18 UNF	G 1/4"-18	● 341 000 604	● 340 000 604
9/16"-18 UNF	G 3/8"-18	● 341 000 606	● 340 000 606
3/4"-16 UNF	G 3/8"-18	● 341 000 806	● 340 000 806
3/4"-16 UNF	G 1/2"-14	● 341 000 808	● 340 000 808
7/8"-14 UNF	G 1/2"-14	● 341 001 008	● 340 001 008
1.1/16"-12 UN	G 3/4"-14	● 341 001 212	● 340 001 212
1.5/16"-12 UN	G 1"-11,5	● 341 001 616	● 340 001 616
1.5/8"-12 UN	G 1.1/4"-11,5	● 341 002 020	● 340 002 020
1.7/8"-12 UN	G 1.1/2"-11,5	● 341 002 424	● 340 002 424



ADATTATORI DI COLLEGAMENTO
CONNECTING ADAPTORS

ADATTATORI ORFS
ORFS ADAPTORS



BUSSOLA



DADO



Ø Tubo Rigido OD Tube	Bussola Metrica per tubo rigido Tube Sleeve Metric	Filetto Thread	Dado di serraggio ORFS per tubo rigido
Inch	Codice / Part. nr.	Inch	Codice / Part. nr.
8	• 400 101 008	9/16"-18 UNF	• 345 151 109
10	• 400 101 010	11/16"-16 UN	• 345 151 111
12	• 400 101 012	13/16"-16 UN	• 345 151 113
16	• 400 101 014	1"-14 UNS	• 345 151 116
20	• 400 101 020	1.3/16"-12 UN	• 345 151 119
25	• 400 101 025	1.7/16"-12 UN	• 345 151 123
30	• 400 101 030	1.11/16"-12 UN	• 345 151 127
		2"-12 UN	• 345 151 132

NIPPLI M/M ORFS

**NIPPLIO
M/M ORFS**



**RIDUZIONE
M/M ORFS**



Filetto Thread	Nipplo M/M ORFS ORFS M/M Union	Filetto G1 G1 Thread	Filetto G2 G2 Thread	Riduzione M/M ORFS ORFS M/M Reducing
Inch	Codice / Part. nr.	Inch	Inch	Codice / Part. nr.
9/16"-18 UNF	• 346 000 909	9/16"-18 UNF	11/16"-16 UN	• 346 000 911
11/16"-16 UN	• 346 001 111	11/16"-16 UN	13/16"-16 UN	• 346 001 113
13/16"-16 UN	• 346 001 313	13/16"-16 UN	1"-14 UNS	• 346 001 316
1"-14 UNS	• 346 001 616	1"-14 UNS	1.3/16"-12 UN	• 346 001 619
1.3/16"-12 UN	• 346 001 919	1.3/16"-12 UN	1.7/16"-12 UN	• 346 001 923
1.7/16"-12 UN	• 346 002 323	1.7/16"-12 UN	1.11/16"-12 UN	• 346 002 327
1.11/16"-12 UN	• 346 002 727			
2"-12 UN	• 346 003 232			



ORFS / BSP



Filetto G1 G1 Thread	Filetto G2 G2 Thread	Nipplo M.ORFS/ M.Gas svasato M.ORFS/M.BSP cone 60° Union	Nipplo M.ORFS/ M.Gas piano con o-ring M.ORFS/M.BSP flat o-ring Union
Inch	mm	Codice / Part. nr.	Codice / Part. nr.
9/16"-18 UNF	G 1/8"-28		• 357 000 902
9/16"-18 UNF	G 1/4"-19	• 358 000 904	• 357 000 904
9/16"-18 UNF	G 3/8"-19	• 358 000 906	• 357 000 906
9/16"-18 UNF	G 1/2"-14		• 357 000 908
11/16"-16 UN	G 1/4"-19	• 358 001 104	• 357 001 104
11/16"-16 UN	G 3/8"-19	• 358 001 106	• 357 001 106
11/16"-16 UN	G 1/2"-14	• 358 001 108	• 357 001 108
13/16"-16 UN	G 1/4"-19		• 357 001 304
13/16"-16 UN	G 3/8"-19		• 357 001 306
13/16"-16 UN	G 1/2"-14	• 358 001 308	• 357 001 308
13/16"-16 UN	G 3/4"-14		• 357 001 312
1"-14 UNS	G 3/8"-19		• 357 001 606
1"-14 UNS	G 1/2"-14	• 358 001 608	• 357 001 608
1"-14 UNS	G 3/4"-14	• 358 001 612	• 357 001 612
1.3/16"-12 UN	G 1/2"-14	• 358 001 908	• 357 001 908
1.3/16"-12 UN	G 3/4"-14	• 358 001 912	• 357 001 912
1.3/16"-12 UN	G 1"-11	• 358 001 916	• 357 001 916
1.7/16"-12 UN	G 3/4"-14	• 358 002 312	• 357 002 312
1.7/16"-12 UN	G 1"-11	• 358 002 316	• 357 002 316
1.11/16"-12 UN	G 1"-11		• 357 002 716
1.11/16"-12 UN	G 1.1/4"-11		• 357 002 720
1.11/16"-12 UN	G 1.1/2"-11		• 357 002 724
2"-12 UN	G 1.1/2"-11		• 357 003 224

ADATTATORI ORFS ORFS ADAPTORS

NIPPLI M/M ORFS / JIC / SAE



ORFS

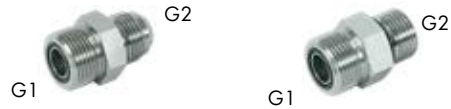

Filetto G1 ORFS ORFS G1 Thread	Filetto G2 JIC/SAE JIC/SAE G2 Thread	Nipplo M.ORFS/ M.JIC 37° M.ORFS/M.JIC 37° Union	Nipplo M.ORFS/ M SAE M.ORFS/M.SAE Union
Inch	Inch	Codice / Part. nr.	Codice / Part. nr.
9/16"-18 UNF	7/16"-20 UNF	● 357 100 904	● 358 100 904
11/16"-16 UN	1/2"-20 UNF	● 357 101 105	
11/16"-16 UN	9/16"-18 UNF	● 357 101 106	● 358 101 106
13/16"-16 UN	3/4"-16 UNF	● 357 101 308	● 358 101 308
1"-14 UNS	7/8"-14 UNF	● 357 101 610	● 358 101 610
1.3/16"-12 UN	1.1/16"-12 UN	● 357 101 912	● 358 101 912
1.7/16"-12 UN	1.5/16"-12 UN	● 357 102 316	● 358 102 316
1.11/16"-12 UN	1.5/8"-12 UN	● 357 102 720	
2"-12 UN	1.7/8"-12 UN		● 358 103 224

ADATTATORI CON FEM.GIREVOLE ORFS

M/F.GIREVOLE F/F.GIREVOLE ORFS

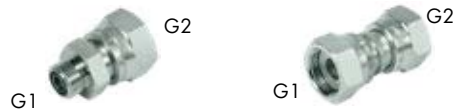

Filetto G1 G1 Thread	Filetto G2 G2 Thread	Adattatore M./F. girevole ORFS ORFS M./F.swivel Adaptors	Adattatore F./F. girevole ORFS ORFS F./F.swivel Adaptors
Inch	Inch	Codice / Part. nr.	Codice / Part. nr.
9/16"-18 UNF	9/16"-18 UNF		● 353 000 909
9/16"-18 UNF	11/16"-16 UN	● 350 000 911	
11/16"-16 UN	11/16"-16 UN		● 353 001 111
11/16"-16 UN	13/16"-16 UN	● 350 001 113	
11/16"-16 UN	1"-14 UNS	● 350 001 116	
11/16"-16 UN	1.3/16"-12 UN	● 350 001 119	
13/16"-16 UN	13/16"-16 UN		● 353 001 313
13/16"-16 UN	1.3/16"-12 UN	● 350 001 319	
1"-14 UNS	1"-14 UNS		● 353 001 616
1"-14 UNS	1.7/16"-12 UN	● 350 001 623	
1.3/16"-12 UN	1.3/16"-12 UN		● 353 001 919
1.7/16"-12 UN	1.7/16"-12 UN		● 353 002 323
1.11/16"-12 UN	1.11/16"-12 UN		● 353 002 727
2"-12 UN	2"-12 UN		● 353 003 232

● Fornibile in 7 gg lavorativi / Available in 7 working days

ADATTATORI ORFS ORFS ADAPTORS

ADATTATORI M.BSP / F.GIREVOLE ORFS



M. BSP/F.GIREVOLE ORFS



Filetto G1 G1 Thread	Filetto G2 G2 Thread	Adattatore M.Gas/F. girevole ORFS M.BSP/F.ORFS swivel Adaptors
Inch	Inch	Codice / Part. nr.
9/16"-18 UNF	G 1/4"-19	362 000 904
11/16"-16 UN	G 1/4"-19	362 001 104
11/16"-16 UN	G 3/8"-19	362 001 106
11/16"-16 UN	G 1/2"-14	362 001 108
13/16"-16 UN	G 3/8"-19	362 001 306
13/16"-16 UN	G 1/2"-14	362 001 308
1"-14 UNS	G 1/2"-14	362 001 608
1"-14 UNS	G 3/4"-14	362 001 612
1.3/16"-12 UN	G 3/4"-14	362 001 912
1.3/16"-12 UN	G 1"-11	362 001 916
1.7/16"-12 UN	G 1"-11	362 002 316

TAPPI ORFS

ORFS

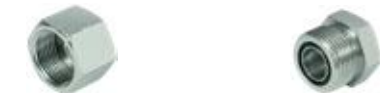

Filetto Thread	Tappo Femmina ORFS ORFS Female Plug	Tappo Maschio ORFS ORFS Male Plug
Inch	Codice / Part. nr.	Codice / Part. nr.
9/16"-18 UNF	343 051 009	344 051 009
11/16"-16 UN	343 051 011	344 051 011
13/16"-16 UN	343 051 013	344 051 013
1"-14 UNS	343 051 016	344 051 016
1.3/16"-12 UN	343 051 019	344 051 019
1.7/16"-12 UN	343 051 023	344 051 023
1.11/16"-12 UN	● 343 051 027	● 344 051 027
2"-12 UN	● 343 051 032	● 344 051 032

● Fornibile in 7 gg lavorativi / Available in 7 working days



ORFS



Filetto G1 G1 Thread	Passaparete ORFS completo di dado ORFS Bulkhead nut completed	Passaparete 90° ORFS completo di dado 90° ORFS Bulkhead nut completed
Inch	Codice / Part. nr.	Codice / Part. nr.
9/16"-18 UNF	347 000 909	• 348 000 909
11/16"-16 UN	347 001 111	• 348 001 111
13/16"-16 UN	347 001 313	• 348 001 313
1"-14 UNS	347 001 616	• 348 001 616
1.3/16"-12 UN	347 001 919	• 348 001 919
1.7/16"-12 UN	• 347 002 323	• 348 002 323
1.11/16"-12 UN	• 347 002 727	
2"-12 UN	• 347 003 232	

ADATTATORI STAMPATI ORFS

**GOMITO M/M
ORFS**



G2

G1

Filetto G1 G1 Thread	Passaparete ORFS completo di dado ORFS Bulkhead nut completed
Inch	Codice / Part. nr.
9/16"-18 UNF	• 349 000 909
11/16"-16 UN	• 349 001 111
13/16"-16 UN	• 349 001 313
1"-14 UNS	• 349 001 616
1.3/16"-12 UN	• 349 001 919
1.7/16"-12 UN	• 349 002 323
1.11/16"-12 UN	• 349 002 727
2"-12 UN	• 349 003 232

• Fornibile in 7 gg lavorativi / Available in 7 working days



**GOMITO M/M
ORFS / BSP**



Filetto G1 G1 Thread	Filetto G2 G2 Thread	Gomito 90° M.ORFS/ M.Gas orientabile 90° M.ORFS/M.BSP adjustable Elbow	Gomito 45° M.ORFS/ M.Gas orientabile 45° M.ORFS/M.BSP adjustable Elbow
Inch	Inch	Codice / Part. nr.	Codice / Part. nr.
9/16"-18 UNF	G 1/4"-19	• 359 000 904	• 360 000 904
9/16"-18 UNF	G 3/8"-19	• 359 000 906	
11/16"-16 UN	G 3/8"-19	• 359 001 106	• 360 001 106
11/16"-16 UN	G 1/2"-14	• 359 001 108	• 360 001 108
13/16"-16 UN	G 1/4"-19	• 359 001 304	
13/16"-16 UN	G 3/8"-19	• 359 001 306	• 360 001 306
13/16"-16 UN	G 1/2"-14	• 359 001 308	
1"-14 UNS	G 1/2"-14	• 359 001 608	• 360 001 608
1"-14 UNS	G 3/4"-14	• 359 001 612	
1.3/16"-12 UN	G 1/2"-14	• 359 001 908	
1.3/16"-12 UN	G 3/4"-14	• 359 001 912	• 360 001 912
1.3/16"-12 UN	G 1"-11	• 359 001 916	
1.7/16"-12 UN	G 1"-11	• 359 002 316	• 360 002 316

ADATTATORI STAMPATI ORFS / SAE

**GOMITO M/M
ORFS**



Filetto G1 G1 Thread	Filetto G2 G2 Thread	Passaparete ORFS completo di dado ORFS Bulkhead nut completed
Inch	Inch	Codice / Part. nr.
9/16"-18 UNF	7/16"-20 UNF	• 360 100 904
9/16"-18 UNF	9/16"-18 UNF	• 360 100 906
11/16"-16 UN	9/16"-18 UNF	• 360 101 106
13/16"-16 UN	9/16"-18 UNF	• 360 101 306
13/16"-16 UN	3/4"-16 UNF	• 360 101 308
1"-14 UNS	7/8"-14 UNF	• 360 101 610
1.3/16"-12 UN	1.1/16"-12 UN	• 360 101 912
1.3/16"-12 UN	1.5/16"-12 UN	• 360 101 916
1.7/16"-12 UN	1.5/8"-12 UN	• 360 102 320

• Fornibile in 7 gg lavorativi / Available in 7 working days



**GOMITO M/F.
GIREVOLE ORFS**



Filetto Thread		Gomito 90° M/Fem. girevole ORFS 90° M/F.swivel ORFS Elbow		Gomito 45° M/Fem. girevole ORFS 45° M/F.swivel ORFS Elbow
Inch		Codice / Part. nr.		Codice / Part. nr.
9/16"-18 UNF	●	352 000 909	●	351 000 909
11/16"-16 UN	●	352 001 111	●	351 001 111
13/16"-16 UN	●	352 001 313	●	351 001 313
1"-14 UNS	●	352 001 616	●	351 001 616
1.3/16"-12 UN	●	352 001 919		
1.7/16"-12 UN	●	352 002 323		
1.11/16"-12 UN	●	352 002 727		
2"-12 UN	●	352 003 232		

**TEE M/M/M
ORFS / BSP**



Filetto G1 G1 Thread	Filetto G2 G2 Thread		TEE M.ORFS/M.Gas orientabile centrale/ M.ORFS M.ORFS/M.BSP adjustable central/M. ORFS TEE
Inch	Inch		Codice / Part. nr.
9/16"-18 UNF	G 1/4"-19	●	361 001 904
11/16"-16 UN	G 1/4"-19	●	361 001 104
11/16"-16 UN	G 3/8"-19	●	361 001 106
13/16"-16 UN	G 3/8"-19	●	361 001 306
13/16"-16 UN	G 1/2"-14	●	361 001 308
1"-14 UNS	G 1/2"-14	●	361 001 608
1"-14 UNS	G 3/4"-14	●	361 001 612
1.3/16"-12 UN	G 3/4"-14	●	361 001 912
1.7/16"-12 UN	G 1"-11	●	361 002 316

**TEE M/M/M
ORFS**



Filetto Thread		TEE M/M/M ORFS M/M/M ORFS TEE
Inch		Codice / Part. nr.
9/16"-18 UNF	●	354 090 909
11/16"-16 UN	●	354 111 111
13/16"-16 UN	●	354 131 313
1"-14 UNS	●	354 161 616
1.3/16"-12 UN	●	354 191 919
1.7/16"-12 UN	●	354 232 323
1.11/16"-12 UN	●	354 272 727
2"-12 UN	●	354 323 232

**TEE M/FEM.
GIREVOLE ORFS**



Filetto Thread		TEE M./M./F.girevole laterale ORFS ORFS M./M./F.swivel lateral TEE		TEE M./F.girevole centrale/ M. ORFS ORFS M./F.swivel central/ M. TEE
Inch		Codice / Part. nr.		Codice / Part. nr.
9/16"-18 UNF	●	355 090 909	●	356 090 909
11/16"-16 UN	●	355 111 111	●	356 111 111
13/16"-16 UN	●	355 131 313	●	356 131 313
1"-14 UNS	●	355 161 616	●	356 161 616
1.3/16"-12 UN	●	355 191 919	●	356 191 919
1.7/16"-12 UN	●	355 232 323	●	356 232 323
1.11/16"-12 UN	●	355 272 727	●	356 272 727
2"-12 UN	●	355 323 232	●	356 323 232



ADATTATORI DI COLLEGAMENTO
CONNECTING ADAPTORS

ADATTATORI JIS 60°
JIS 60° ADAPTORS

ADATTATORI JIS 60° JIS 60° ADAPTORS

ADATTATORI JIS "KOMATSU"



FILETTO METRICO



Filetto Thread	Nipplo JIS 60° "Komatsu" "Komatsu" JIS 60° Union	Tappo Maschio JIS 60° "Komatsu" "Komatsu" JIS 60° Male Plug	Tappo Femmina JIS 60° "Komatsu" "Komatsu" JIS 60° Female Plug
mm	Codice / Part. nr.	Codice / Part. nr.	Codice / Part. nr.
M 14x1,5	• 363 142 142	364 142 142	365 142 142
M 16x1,5	• 363 162 162	364 162 162	365 162 162
M 18x1,5	• 363 182 182	364 182 182	365 182 182
M 22x1,5	• 363 222 222	• 364 222 222	• 365 222 222
M 24x1,5	• 363 242 242	• 364 242 242	• 365 242 242
M 28x1,5			• 365 282 282
M 30x1,5	• 363 302 302	• 364 302 302	• 365 302 302
M 33x1,5	• 363 332 332	• 364 332 332	• 365 332 332
M 36x1,5			• 365 362 362

ADATTATORI JIS 60° JIS 60° ADAPTORS

ADATTATORI JIS "TOYOTA"



FILETTO METRICO



Filetto Thread	Nipplo JIS 60° "Toyota" "Toyota" JIS 60° Union	Tappo Maschio JIS 60° "Toyota" "Toyota" JIS 60° Male Plug	Tappo Femmina JIS 60° "Toyota" "Toyota" JIS 60° Female Plug
Inch	Codice / Part. nr.	Codice / Part. nr.	Codice / Part. nr.
G 1/4"-19	367 004 004	368 004 004	• 369 004 004
G 3/8"-19	367 006 006	368 006 006	369 006 006
G 1/2"-14	367 008 008	368 008 008	• 369 008 008
G 3/4"-14	367 012 012	• 368 012 012	• 369 012 012
G 1"-11		• 368 016 016	• 369 016 016

ADATTATORI JIS/BSP "KOMATSU"

FILETTO JIS METRICO/BSP

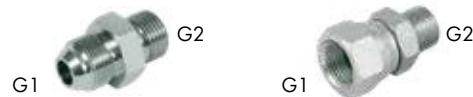

Filetto G1 G1 Thread	Filetto G2 G2 Thread	Nipplo M.JIS 60° Metrico/ M.Gas "Komatsu" "Komatsu" M.JIS 60° Metric/M.BSP Union	Adattatore F.JIS 60° Metrico/ M.Gas "Komatsu" "Komatsu" F.JIS 60° Metric/M.BSP Union
Inch	Inch	Codice / Part. nr.	Codice / Part. nr.
M 14x1,5	G 1/4"-19	• 366 142 004	• 371 142 004
M 18x1,5	G 3/8"-19	• 366 182 006	• 371 182 006
M 20x1,5	G 1/2"-14	• 366 202 008	
M 22x1,5	G 3/8"-19	• 366 222 006	
M 22x1,5	G 1/2"-14	• 366 222 008	• 371 222 008
M 24x1,5	G 5/8"-14	• 366 242 010	
M 30x1,5	G 3/4"-14	• 366 302 012	• 371 302 012
M 33x1,5	G 1"-11	• 366 332 016	

ADATTATORI JIS/BSP "TOYOTA"

FILETTO JIS METRICO/BSP



Filetto G1 G1 Thread	Filetto G2 G2 Thread	Nipplo M.JIS 60° Gas/ M.Gas "Toyota" "Toyota" JIS 60° BSP/ BSP Union	Adattatore F.JIS 60° Gas/M.Gas con."Toyota" "Toyota" F.JIS 60° BSP/M.BSPT Union
Inch	Inch	Codice / Part. nr.	Codice / Part. nr.
G 1/4"-19	G 1/4"-19	• 370 004 004	• 371 004 004
G 3/8"-19	G 3/8"-19	• 370 006 006	• 371 006 006
G 1/2"-14	G 3/8"-19	• 370 008 006	• 371 008 006
G 1/2"-14	G 1/2"-14	• 370 008 008	• 371 008 008
G 3/4"-14	G 3/4"-14	• 370 012 012	• 371 012 012
G 1"-11	G 1"-11	• 370 016 016	• 371 016 016



ADATTATORI DI COLLEGAMENTO
CONNECTING ADAPTORS

ADATTATORI IDROPULITRICE
CLEANERS ADAPTORS

ADATTATORI CON GIRELLA



FILETTO METRICO/BSP

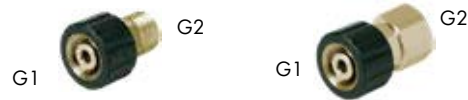

Filetto G1 G1 Thread	Perno Ø Ø Pin	Filetto G2 G2 Thread	Adattatore Fem.Idro/ M.Gas cilindrico Cleaner Fem.swivel/ M.BSP Adaptors	Adattatore Fem.Idro/ Fem.Gas cilindrico Cleaner Fem.swivel/ Fem.BSP Adaptors
mm	mm	Inch	Codice / Part. nr.	Codice / Part. nr.
M 22x1,5	14	G 1/4"-19	373 222 140	374 222 140
M 22x1,5	14	G 3/8"-19	373 222 380	374 222 380
M 22x1,5	14	G 1/2"-14	373 222 120	374 222 120

RIDUZIONI FISSE

FILETTO METRICO/BSP

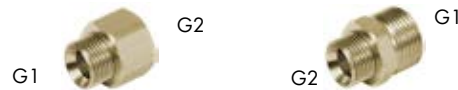

Filetto G1 G1 Thread	Perno Ø Ø Pin	Filetto G2 G2 Thread	Adattatore Maschio Idro/Femmina Gas Cleaner Male/Female BSP Adaptors	Riduzione Maschio Idro/Maschio Gas Cleaner Male/Male BSP Reducing
mm	mm	Inch	Codice / Part. nr.	Codice / Part. nr.
M 22x1,5	14	G 1/4"-19	372 222 140	375 222 140
M 22x1,5	14	G 3/8"-19	372 222 380	375 222 380
M 22x1,5	14	G 1/2"-14	372 222 120	375 222 120

NIPPO DI COLLEGAMENTO

FILETTO METRICO



Filetto Thread	Perno Ø Ø Pin	Nipplo Maschio Idro/ Maschio Idro
mm	mm	Codice / Part. nr.
M 22x1,5	14	375 222 222

● Fornibile in 7 gg lavorativi / Available in 7 working days

LANCIA PER IDROPULITRICE



PISTOLA CON MECCANISMO IN OTTONE E ACCIAIO
LANCIA IN TUBO ZINCATO



Entrata Inlet	Lunghezza Lancia Lance Length	Pressione Esercizio Working Pressure	Temperatura Esercizio Working Temperature	Portata Nominale Rated Flow Rate	Fattore Portata Ugello Inox 25° 25° Stainless Steel Nozzle Size	Lancia per Idropulitrice Hydrocleaner Gun
Inch	mm	bar	°C	l/min.		Codice / Part. nr.
G 1/4"-19	900	280	160	30/40	4	376 040 900
G 1/4"-19	1200	280	160	30/40	4	376 041 200
G 1/4"-19	1500	280	280	30/40	4	376 041 500
G 1/4"-19	1700	280	280	30/40	4	376 041 700

PISTOLA CON MECCANISMO IN ACCIAIO INOX
LANCIA CON TUBO INOX



Entrata Inlet	Lunghezza Lancia Lance Length	Pressione Esercizio Working Pressure	Temperatura Esercizio Working Temperature	Portata Nominale Rated Flow Rate	Fattore Portata Ugello Inox 25° 25° Stainless Steel Nozzle Size	Lancia per Idropulitrice Hydrocleaner Gun
Inch	mm	bar	°C	l/min.		Codice / Part. nr.
G 1/4"-19	900	280	160	30/40	4 ●	376 140 900
G 1/4"-19	1200	280	160	30/40	4 ●	376 141 200

● Fornibile in 7 gg lavorativi / Available in 7 working days



ADATTATORI DI COLLEGAMENTO
CONNECTING ADAPTORS

ADATTATORI SERIE "ASA"
"ASA" SERIES ADAPTORS

ADATTATORI SERIE "ASA"
"ASA" SERIES ADAPTORS

ADATTATORI ASA 3000



ASA 3000



Filetto Thread	Manicotto Femmina Serie ASA 3000 Female Coupling ASA 3000 Series	Gomito Fem./Fem. Serie ASA 3000 90° Fem./Fem. Elbow ASA 3000 Series	TEE Fem./Fem./Fem. Serie ASA 3000 Fem./Fem./Fem. TEE ASA 3000 Series
Inch	Codice / Part. nr.	Codice / Part. nr.	Codice / Part. nr.
G 1/4"-19	● 376 050 304	● 376 090 304	● 376 100 304
G 3/8"-19	● 376 050 306	● 376 090 306	● 376 100 306
G 1/2"-14	● 376 050 308	● 376 090 308	● 376 100 308
G 3/4"-14	● 376 050 312	● 376 090 312	● 376 100 312
G 1"-11	● 376 050 316	● 376 090 316	● 376 100 316
G 1.1/4"-11	● 376 050 320	● 376 090 320	● 376 100 320
G 1.1/2"-11	● 376 050 324	● 376 090 324	● 376 100 324
G 2"-11	● 376 050 332	● 376 090 332	● 376 100 332

● Fornibile in 7 gg lavorativi / Available in 7 working days

ADATTATORI SERIE "ASA"
"ASA" SERIES ADAPTORS

ADATTATORI ASA 6000



ASA 3000



Filetto Thread	Manicotto Femmina Serie ASA 6000 Female Coupling ASA 6000 Series	Gomito Fem./Fem. Serie ASA 6000 90° Fem./Fem. Elbow ASA 6000 Series	TEE Fem./Fem./Fem. Serie ASA 6000 Fem./Fem./Fem. TEE ASA 6000 Series
Inch	Codice / Part. nr.	Codice / Part. nr.	Codice / Part. nr.
G 1/4"-19	● 376 050 604	● 376 090 604	● 376 100 604
G 3/8"-19	● 376 050 606	● 376 090 606	● 376 100 606
G 1/2"-14	● 376 050 608	● 376 090 608	● 376 100 608
G 3/4"-14	● 376 050 612	● 376 090 612	● 376 100 612
G 1"-11	● 376 050 616	● 376 090 616	● 376 100 616
G 1.1/4"-11	● 376 050 620	● 376 090 620	● 376 100 620
G 1.1/2"-11	● 376 050 624	● 376 090 624	● 376 100 624
G 2"-11	● 376 050 632	● 376 090 632	● 376 100 632

● Fornibile in 7 gg lavorativi / Available in 7 working days



ADATTATORI DI COLLEGAMENTO
CONNECTING ADAPTORS

ADATTATORI "FLANGE SAE"
"SAE FLANGES" ADAPTORS

ADATTATORI "FLANGE SEA" "SEA FLANGES" ADAPTORS

FLANGE FILETTATE SAE



SAE 3000



Flangia SAE 3000 SAE 3000 Flange	Filetto Thread	Flangia Filettata 3000 PSI Threaded Flange 3000 PSI	Flangia 90° Filettata 3000 PSI Threaded 90° Flange 3000 PSI	Flangia Cieca 3000 PSI Locking Flange 3000 PSI
Inch	Inch	Codice / Part. nr.	Codice / Part. nr.	Codice / Part. nr.
1/2"	G 3/8"-19	● 376 000 380	● 377 000 380	
1/2"	G 1/2"-14	● 376 000 120	● 377 000 120	● 378 000 120
3/4"	G 3/4"-14	● 376 000 340	● 377 000 340	● 378 000 340
1"	G 1"-11	● 376 000 100	● 377 000 100	● 378 000 100
1.1/4"	G 1.1/4"-11	● 376 000 114	● 377 000 114	● 378 000 114
1.1/2"	G 1.1/2"-11	● 376 000 112	● 377 000 112	● 378 000 112
2"	G 2"-11	● 376 000 200	● 377 000 200	● 378 000 200
2.1/2"	G 2.1/2"-11	● 376 000 212		
3"	G 3"-11	● 376 000 300		

Bulloni e O-ring inclusi / Included Bolt and O-rings

SAE 6000



Flangia SAE 6000 SAE 6000 Flange	Filetto Thread	Flangia Filettata 6000 PSI Threaded Flange 6000 PSI	Flangia 90° Filettata 6000 PSI Threaded 90° Flange 6000 PSI	Flangia Cieca 6000 PSI Locking Flange 6000 PSI
Inch	Inch	Codice / Part. nr.	Codice / Part. nr.	Codice / Part. nr.
1/2"	G 3/8"-19	● 379 000 380	● 380 000 380	
1/2"	G 1/2"-14	● 379 000 120	● 380 000 120	● 381 000 120
3/4"	G 3/4"-14	● 379 000 340	● 380 000 340	● 381 000 340
1"	G 1"-11	● 379 000 100	● 380 000 100	● 381 000 100
1.1/4"	G 1.1/4"-11	● 379 000 114	● 380 000 114	● 381 000 114
1.1/2"	G 1.1/2"-11	● 379 000 112	● 380 000 112	● 381 000 112
2"	G 2"-11	● 379 000 200	● 380 000 200	● 381 000 200

Bulloni e O-ring non inclusi / Not included Bolt and O-rings

ADATTATORI "FLANGE SEA" "SEA FLANGES" ADAPTORS

CONTROFLANGE FILETTATE SAE



SAE 3000



Controflangia SAE 3000 SAE 3000 Counter-Flange	Filetto Thread	Controflangia Filettata 3000 PSI Threaded Counter- Flange 3000 PSI
Inch	Inch	Codice / Part. nr.
1/2"	G 3/8"-19	● 382 000 380
1/2"	G 1/2"-14	● 382 000 120
3/4"	G 3/4"-14	● 382 000 340
1"	G 1"-11	● 382 000 100
1.1/4"	G 1.1/4"-11	● 382 000 114
1.1/2"	G 1.1/2"-11	● 382 000 112
2"	G 2"-11	● 382 000 200
2.1/2"	G 2.1/2"-11	● 382 000 212
3"	G 3"-11	● 382 000 300

Bulloni e O-ring non inclusi / Not included Bolt and O-rings

SAE 6000



Controflangia SAE 6000 SAE 6000 Counter-Flange	Filetto Thread	Controflangia Filettata 6000 PSI Threaded Counter- Flange 6000 PSI
Inch	Inch	Codice / Part. nr.
1/2"	G 3/8"-19	● 384 000 380
1/2"	G 1/2"-14	● 384 000 120
3/4"	G 3/4"-14	● 384 000 340
1"	G 1"-11	● 384 000 100
1.1/4"	G 1.1/4"-11	● 384 000 114
1.1/2"	G 1.1/2"-11	● 384 000 112
2"	G 2"-11	● 384 000 200

Bulloni e O-ring non inclusi / Not included Bolt and O-rings

ADATTATORI "FLANGE SEA" "SEA FLANGES" ADAPTORS

FLANGE A SALDARE DI TASCA SAE



SAE 3000



Flangia SAE 3000 SAE 3000 Flange	Tasca Socket	Flangia a Saldare di tasca 3000 PSI Socket Welded Flange 3000 PSI	Flangia 90° a Saldare di tasca 3000 PSI Socket Welded 90° Flange 3000 PSI
Inch	mm	Codice / Part. nr.	Codice / Part. nr.
1/2"	21,6	● 386 000 120	● 387 000 120
3/4"	27,2	● 386 000 340	● 387 000 340
1"	34,0	● 386 000 100	● 387 000 100
1.1/4"	42,8	● 386 000 114	● 387 000 114
1.1/2"	48,6	● 386 000 112	● 387 000 112
2"	61,0	● 386 000 200	● 387 000 200
2.1/2"	76,6	● 386 000 212	
3"	90,5	● 386 000 300	

Bulloni e O-ring non inclusi / Not included Bolt and O-rings

SAE 3000



Flangia SAE 3000 SAE 3000 Flange	Tasca Socket	Flangia a Saldare di tasca 6000 PSI Socket Welded Flange 6000 PSI	Flangia 90° a Saldare di tasca 6000 PSI Socket Welded 90° Flange 6000 PSI
Inch	mm	Codice / Part. nr.	Codice / Part. nr.
1/2"	21,6	● 388 000 120	● 389 000 120
3/4"	27,2	● 388 000 340	● 389 000 340
1"	34,0	● 388 000 100	● 389 000 100
1.1/4"	42,8	● 388 000 114	● 389 000 114
1.1/2"	48,6	● 388 000 112	● 389 000 112
2"	61,0	● 388 000 200	● 389 000 200
2.1/2"	76,6	● 388 000 212	

Bulloni e O-ring non inclusi / Not included Bolt and O-rings

● Fornibile in 7 gg lavorativi / Available in 7 working days

ADATTATORI "FLANGE SEA" "SEA FLANGES" ADAPTORS

CONTROFLANGE A SALDARE DI TASCA SAE



SAE 3000



Controflangia SAE 3000 SAE 3000 Counter-Flange	Filetto Thread	Controflangia a Saldare di tasca 3000 PSI Socket Welded Counter- Flange 3000 PSI
Inch	mm	Codice / Part. nr.
1/2"	21,6	● 390 000 120
3/4"	27,2	● 390 000 340
1"	34,0	● 390 000 100
1.1/4"	42,8	● 390 000 114
1.1/2"	48,6	● 390 000 112
2"	61,0	● 390 000 200
2.1/2"	76,6	● 390 000 212
3"	90,5	● 390 000 300

Bulloni e O-ring non inclusi / Not included Bolt and O-rings

SAE 6000



Controflangia SAE 6000 SAE 6000 Counter-Flange	Filetto Thread	Controflangia a Saldare di tasca 6000 PSI Socket Welded Counter- Flange 6000 PSI
Inch	Inch	Codice / Part. nr.
1/2"	21,6	392 000 120
3/4"	27,2	392 000 340
1"	34,0	392 000 100
1.1/4"	42,8	392 000 114
1.1/2"	48,6	392 000 112
2"	61,0	392 000 200
2.1/2"	76,6	392 000 212

Bulloni e O-ring non inclusi / Not included Bolt and O-rings

● Fornibile in 7 gg lavorativi / Available in 7 working days

ADATTATORI "FLANGE SEA" "SEA FLANGES" ADAPTORS

TAPPI FLANGE



Flangia Flange	Tappo Flangia 3000 PSI 3000 PSI Plug Flange	Tappo Flangia 6000 PSI 6000 PSI Plug Flange
Inch	Codice / Part. nr.	Codice / Part. nr.
1/2"	● 393 000 120	● 394 000 120
3/4"	● 393 000 340	● 394 000 340
1"	● 393 000 100	● 394 000 100
1.1/4"	● 393 000 114	● 394 000 114
1.1/2"	● 393 000 112	● 394 000 112
2"	● 393 000 200	● 394 000 200

HSR®

ADATTATORI "FLANGE SEA" "SEA FLANGES" ADAPTORS

CONTROFLANGE A SALDARE DI TASCA SAE

HSR®

SAE 3000



Flangia Flange	Filetto Thread		Adattatore Flangia 3000/M.Metrico 24° Flange 3000/M.Metric 24° Adaptor	Adattatore 90° Flangia 3000/M.Metrico 24° 90° Flange 3000/M. Metric 24° Adaptor
Inch	mm	Ø	Codice / Part. nr.	Codice / Part. nr.
1/2"	M 20x1,5	12S	● 385 008 202	● 385 908 202
1/2"	M 24x1,5	16S	● 385 008 242	
3/4"	M 24x1,5	16S	● 385 012 242	
3/4"	M 30x2	20S	● 385 012 303	
1"	M 30x2	20S	● 385 016 303	● 385 916 303
1"	M 36x2	25S	● 385 016 363	● 385 916 363
1.1/4"	M 36x2	25S	● 385 020 363	● 385 020 363

FLANGE PER POMPE



Filetto Thread	Interasse fori Hole Inter-axis	Raccordo 90° 3 fori filettato femmina 3 Hole 90° Female Connectore	Raccordo 90° 4 fori filettato femmina 4 Hole 90° Female Connectore
Inch	mm	Codice / Part. nr.	Codice / Part. nr.
3/8"	30	394 006 030	396 006 030
3/8"	40	394 006 040	
1/2"	30	394 008 030	396 008 030
1/2"	40	● 394 008 040	
3/4"	40	394 012 040	
3/4"	51	● 394 012 051	
3/4"	56	● 394 012 056	
1"	51	394 016 051	
1"	56	● 394 016 056	
1.1/4"	62	● 394 020 062	

Bulloni e O-ring non inclusi / Not included Bolt and O-rings

SAE 6000



Flangia Flange	Filetto Thread		Adattatore Flangia 6000/M.Metrico 24° Flange 6000/M.Metric 24° Adaptor	Adattatore 90° Flangia 6000/M.Metrico 24° 90° Flange 6000/M. Metric 24° Adaptor
Inch	mm	Ø	Codice / Part. nr.	Codice / Part. nr.
1/2"	M 20x1,5	12S	● 386 008 202	● 386 908 202
1/2"	M 22x1,5	14S	● 386 008 222	
1/2"	M 24x1,5	16S	● 386 008 242	
3/4"	M 24x1,5	16S		● 386 912 242
3/4"	M 30x2	20S	● 386 012 303	● 386 912 303
3/4"	M 36x2	25S	● 386 012 363	● 386 912 363
1"	M 30x2	20S		● 386 916 303
1"	M 36x2	25S	● 386 016 363	● 386 916 363
1"	M 42x2	30S	● 386 016 423	● 386 916 423
1.1/4"	M 36x2	25S		● 386 920 363
1.1/4"	M 42x2	30S	● 386 020 423	● 386 920 423
1.1/2"	M 42x2	30S	● 386 024 423	● 386 924 423
1.1/2"	M 52x2	38S	● 386 024 523	● 386 924 523

● Fornibile in 7 gg lavorativi / Available in 7 working days

● Fornibile in 7 gg lavorativi / Available in 7 working days



ACCESSORI PER IL FISSAGGIO
FIXING ACCESSORIES

RONDELLE E O-RINGS
GASKET & O-RINGS



POLLICI



Misura Size	Ø interno inside Ø	Ø esterno outside Ø	Spessore Thickness	Rondelle Bonded Autocentranti in Pollici Inches Bonded Self-centring Seals
Inch	mm	mm	mm	Codice / Part. nr.
1/8"	10,37	15,88	2,03	902 010 002
1/4"	13,74	20,57	2,03	902 010 004
3/8"	17,28	23,80	2,03	902 010 006
1/2"	21,54	28,58	2,34	902 010 008
5/8"	23,49	31,75	2,34	902 010 010
3/4"	27,05	34,93	2,34	902 010 012
7/8"	30,81	38,10	2,50	902 010 014
1"	33,89	42,80	3,25	902 010 016
1.1/4"	42,93	52,38	3,25	902 010 020
1.1/2"	48,44	58,60	3,25	902 010 024
2"	60,58	73,03	3,25	902 010 032
2.1/2"	76,08	90,17	3,25	902 010 040
3"	89,09	101,35	3,25	902 010 048

Misura Size	Rondelle Bonded Autocentranti in Pollici Inches Bonded Self-centring Seals	Assortimento (500 pz.) Assortiment (500 pcs.)
Inch	Codice / Part. nr.	Pz. / Pcs. Codice / Part. nr.
1/8"	902 010 002	100
1/4"	902 010 004	100
3/8"	902 010 006	100
1/2"	902 010 008	100
3/4"	902 010 012	50
1"	902 010 016	50

999 001 063



METRICHE



Misura Size	Ø interno inside Ø	Ø esterno outside Ø	Spessore Thickness	Rondelle Bonded Autocentranti Metriche Metric Bonded Self-centring Seals
mm	mm	mm	mm	Codice / Part. nr.
M5	5,7	9,0	1,0	902 020 005
M6	6,7	11,0	1,0	902 020 006
M8	8,7	14,0	1,0	902 020 008
M10	10,7	16,0	1,5	902 020 010
M12	12,7	18,0	1,5	902 020 012
M13	13,7	20,0	1,5	902 020 013
M14	14,7	22,0	1,5	902 020 014
M16	16,7	24,0	1,5	902 020 016
M17	17,4	24,0	1,5	902 020 017
M18	18,7	26,0	1,5	902 020 018
M20	20,7	28,0	1,5	902 020 020
M22	22,7	30,0	2,0	902 020 022
M24	24,7	32,0	2,0	902 020 024
M26	26,7	35,0	2,0	902 020 026
M27	27,05	34,93	2,34	902 020 027
M28	27,7	36,0	2,0	902 020 028
M33	33,89	42,8	2,34	902 020 033
M42	42,7	53,0	3,0	902 020 042
M48	48,7	59,0	3,0	902 020 048

Misura Size	Rondelle Bonded Autocentranti in Pollici Inches Bonded Self-centring Seals	Assortimento (500 pz.) Assortiment (500 pcs.)
Inch	Codice / Part. nr.	Pz. / Pcs. Codice / Part. nr.
M8	902 020 008	100
M10	902 020 010	100
M12	902 020 012	100
M14	902 020 014	100
M16	902 020 016	25
M18	902 020 018	25
M20	902 020 020	25
M22	902 020 022	25

999 001 064



POLLICI



Misura Size	Ø interno inside Ø	Ø esterno outside Ø	Spessore Thickness	Confezione Box	Rondelle di Rame in Pollici Inches Copper Seals
Inch	mm	mm	mm	pz/pcs	Codice / Part. nr.
1/8"	10	16	1,5	100	900 000 002
1/4"	13	19	1,5	100	900 000 004
3/8"	17	23	1,5	100	900 000 006
1/2"	21	27	1,5	100	900 000 008
5/8"	24	30	1,5	50	900 000 010
3/4"	27	33	1,5	50	900 000 012
1"	33	40	1,5	50	900 000 016
1.1/4"	42	50	1,5	50	900 000 020
1.1/2"	48	55	1,5	25	900 000 024
2"	60	68	1,5	25	900 000 032
2.1/2"	75	88	1,5	25	900 000 040

RONDELLE DI RAME METRICHE

METRICHE



Misura Size	Ø interno inside Ø	Ø esterno outside Ø	Spessore Thickness	Confezione Box	Rondelle di Rame in Pollici Inches Copper Seals
Inch	mm	mm	mm	pz/pcs	Codice / Part. nr.
M6	6	12	1,5	100	901 000 006
M8	8	14	1,5	100	901 000 008
M10	10	16	1,5	100	901 000 010
M12	12	18	1,5	100	901 000 012
M14	14	20	1,5	100	901 000 014
M16	16	22	1,5	100	901 000 016
M18	18	24	1,5	100	901 000 018
M20	20	26	1,5	100	901 000 020
M22	22	28	1,5	100	901 000 022
M24	24	30	1,5	50	901 000 024
M42	42	50	1,5	25	901 000 042
M48	48	55	1,5	25	901 000 048

● Fornibile in 7 gg lavorativi / Available in 7 working days

Misura Size	Assortimento Rondelle di Rame Pollici/Metriche Assortiment Inches/Metric Copper Seals	Assortimento (500 pz.) Assortiment (500 pcs.)
Inch	Ø int. x Ø est. x spes Pz. / Pcs.	Codice / Part. nr.
1/8"	10x14x1	20 999 001 067
1/4"	13x18x1,5	20
3/8"	17x21x1,5	20
3/8"	17x23x1,5	20
1/2"	21x26x1,5	20
1/2"	21x28x1,5	20
3/4"	27x32x2	10
1"	33x39x2	10
M4	4x8x1	20
M5	5x9x1	20
M6	6x10x1	20
M6	6x12x1	20
M8	8x12x1	20
M8	8x14x1	20
M10	10x16x1	20
M12	12x16x1,5	20
M12	12x18x1,5	20
M14	14x18x1,5	20
M14	14x20x1,5	20
M16	16x20x1,5	20
M18	18x22x1,5	20
M18	18x24x1,5	20
M20	20x24x1,5	20
M20	20x26x1,5	20
M22	22x27x1,5	20
M22	22x29x1,5	20
M24	24x30x2	10
M26	26x32x2	10
M28	28x34x2	10
M30	30x36x2	10



● Fornibile in 7 gg lavorativi / Available in 7 working days

POLLICI



Misura Size	Ø interno inside Ø	Ø esterno outside Ø	Spessore Thickness	Confezione Box	Rondelle di Alluminio in Pollici Inches Aluminium Seals
Inch	mm	mm	mm	pz/pcs	Codice / Part. nr.
1/8"	10	16	1,5	100	904 000 002
1/4"	13	19	1,5	100	904 000 004
3/8"	17	23	1,5	100	904 000 006
1/2"	21	27	1,5	100	904 000 008
5/8"	24	30	1,5	50	904 000 010
3/4"	27	33	1,5	50	904 000 012
1"	33	40	1,5	50	904 000 016
1.1/4"	42	50	1,5	50	904 000 020
1.1/2"	48	55	1,5	25	904 000 024

RONDELLE DI ALLUMINIO METRICHE

METRICHE



Misura Size	Ø interno inside Ø	Ø esterno outside Ø	Spessore Thickness	Confezione Box	Rondelle di Alluminio in Pollici Inches Aluminium Seals
Inch	mm	mm	mm	pz/pcs	Codice / Part. nr.
M6	6	10	1,5	100	904 100 006
M8	8	14	1,5	100	904 100 008
M10	10	16	1,5	100	904 100 010
M12	12	18	1,5	100	904 100 012
M14	14	20	1,5	100	904 100 014
M16	16	24	1,5	100	904 100 016
M18	18	26	1,5	100	904 100 018
M20	20	28	1,5	100	904 100 020
M22	22	28	1,5	100	904 100 022
M24	24	30	1,5	50	904 100 024

● Fornibile in 7 gg lavorativi / Available in 7 working days

Misura Size	Assortimento Rondelle di Alluminio Pollici/ Metriche Assortiment Inches/ Metric Aluminium Seals	Assortimento (540 pz.) Assortiment (540 pcs.)
Inch	Ø int. x Ø est. x spes Pz. / Pcs.	Codice / Part. nr.
1/8"	10x14x1 20	999 001 070
1/4"	13x18x1,5 20	
3/8"	17x21x1,5 20	
3/8"	17x23x1,5 20	
1/2"	21x26x1,5 20	
1/2"	21x28x1,5 20	
3/4"	27x32x2 10	
1"	33x39x2 10	
M4	4x8x1 20	
M5	5x9x1 20	
M6	6x10x1 20	
M6	6x12x1 20	
M8	8x12x1 20	
M8	8x14x1 20	
M10	10x16x1 20	
M12	12x16x1,5 20	
M12	12x18x1,5 20	
M14	14x18x1,5 20	
M14	14x20x1,5 20	
M16	16x20x1,5 20	
M18	18x22x1,5 20	
M18	18x24x1,5 20	
M20	20x24x1,5 20	
M20	20x26x1,5 20	
M22	22x27x1,5 20	
M22	22x29x1,5 20	
M24	24x30x2 10	
M26	26x32x2 10	
M28	28x34x2 10	
M30	30x36x2 10	



● Fornibile in 7 gg lavorativi / Available in 7 working days



Ø interno inside Ø		Spessore Thickness	Kit O-Ring NBR 70 Shore in Pollici Temp.esercizio -30°C / +100°C Inches NBR 70 Shore Kit O-Ring Working Temp. -30°C / +100°C		Assortimento (382 pz.) Assortiment (382 pcs.)
Inch	Inch		Codice / Part. nr.	pz/pcs	
2,90	1,78		903 006 000	20	903 000 003
3,68	1,78		903 007 000	20	
4,48	1,78		903 008 000	20	
5,28	1,78		903 009 000	20	
6,07	1,78		903 010 000	20	
7,66	1,78		903 011 000	20	
9,25	1,78		903 012 000	20	
9,19	2,62		903 110 000	13	
10,78	2,62		903 111 000	13	
12,37	2,62		903 112 000	13	
13,95	2,62		903 113 000	13	
15,54	2,62		903 114 000	13	
17,13	2,62		903 115 000	13	
18,72	2,62		903 116 000	13	
18,64	3,53		903 210 000	10	
20,22	3,53		903 211 000	10	
21,82	3,53		903 212 000	10	
23,40	3,53		903 213 000	10	
24,99	3,53		903 214 000	10	
26,58	3,53		903 215 000	10	
28,17	3,53		903 216 000	10	
29,75	3,53		903 217 000	10	
31,34	3,53		903 218 000	10	
32,92	3,53		903 219 000	10	
34,52	3,53		903 220 000	10	
36,10	3,53		903 221 000	10	
37,69	3,53		903 222 000	10	
37,47	5,33		903 325 000	7	
40,65	5,33		903 326 000	7	
43,82	5,33		903 327 000	7	



Ø interno inside Ø		Spessore Thickness	Kit O-Ring VITON in Pollici Temp.esercizio -15°C / +200°C Inches VITON Kit O-Ring Working Temp. -15°C / +200°C		Assortimento (382 pz.) Assortiment (382 pcs.)
Inch	Inch		Codice / Part. nr.	pz/pcs	
2,90	1,78		907 006 000	20	907 000 003
3,68	1,78		907 007 000	20	
4,48	1,78		907 008 000	20	
5,28	1,78		907 009 000	20	
6,07	1,78		907 010 000	20	
7,66	1,78		907 011 000	20	
9,25	1,78		907 012 000	20	
9,19	2,62		907 110 000	13	
10,78	2,62		907 111 000	13	
12,37	2,62		907 112 000	13	
13,95	2,62		907 113 000	13	
15,54	2,62		907 114 000	13	
17,13	2,62		907 115 000	13	
18,72	2,62		907 116 000	13	
18,64	3,53		907 210 000	10	
20,22	3,53		907 211 000	10	
21,82	3,53		907 212 000	10	
23,40	3,53		907 213 000	10	
24,99	3,53		907 214 000	10	
26,58	3,53		907 215 000	10	
28,17	3,53		907 216 000	10	
29,75	3,53		907 217 000	10	
31,34	3,53		907 218 000	10	
32,92	3,53		907 219 000	10	
34,52	3,53		907 220 000	10	
36,10	3,53		907 221 000	10	
37,69	3,53		907 222 000	10	
37,47	5,33		907 325 000	7	
40,65	5,33		907 326 000	7	
43,82	5,33		907 327 000	7	



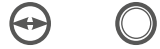

Ø interno inside Ø	Spessore Thickness	Kit O-Ring NBR 70 Shore Metrici Temp.esercizio -30°C / +100°C Metric NBR 70 Shore Kit O-Ring Working Temp. -30°C / +100°C		Assortimento (404 pz.) Assortiment (404 pcs.)
mm	mm	Codice / Part. nr.	pz/pcs	
3	2	903 000 275	18	903 100 003
4	2	903 000 277	18	
5	2	903 000 279	18	
6	2	903 000 281	18	
7	2	903 000 283	17	
8	2	903 000 285	17	
10	2	903 000 289	17	
10	2,5	903 000 527	14	
11	2,5	903 000 529	14	
12	2,5	903 000 531	14	
14	2,5	903 000 535	14	
16	2,5	903 000 539	14	
17	2,5	903 000 541	14	
19	2,5	903 000 545	14	
19	3	903 000 752	12	
20	3	903 000 755	12	
22	3	903 000 759	12	
24	3	903 000 764	12	
25	3	903 000 768	12	
27	3	903 000 773	12	
28	3	903 000 775	12	
30	3	903 000 780	12	
32	3	903 000 784	12	
33	3	903 000 787	12	
35	3	903 000 792	12	
36	3	903 000 794	12	
38	3	903 000 800	12	
38	4	903 001 206	9	
42	4	903 001 210	9	
45	4	903 001 213	9	



Ø interno inside Ø	Spessore Thickness	Kit O-Ring VITON Metrici Temp.esercizio -15°C / +200°C Metric VITON Kit O-Ring Working Temp. -15°C / +200°C		Assortimento (404 pz.) Assortiment (404 pcs.)
mm	mm	Codice / Part. nr.	pz/pcs	
3	2	907 000 275	18	907 100 003
4	2	907 000 277	18	
5	2	907 000 279	18	
6	2	907 000 281	18	
7	2	907 000 283	17	
8	2	907 000 285	17	
10	2	907 000 289	17	
10	2,5	907 000 527	14	
11	2,5	907 000 529	14	
12	2,5	907 000 531	14	
14	2,5	907 000 535	14	
16	2,5	907 000 539	14	
17	2,5	907 000 541	14	
19	2,5	907 000 545	14	
19	3	907 000 752	12	
20	3	907 000 755	12	
22	3	907 000 759	12	
24	3	907 000 764	12	
25	3	907 000 768	12	
27	3	907 000 773	12	
28	3	907 000 775	12	
30	3	907 000 780	12	
32	3	907 000 784	12	
33	3	907 000 787	12	
35	3	907 000 792	12	
36	3	907 000 794	12	
38	3	907 000 800	12	
38	4	907 001 206	9	
42	4	907 001 210	9	
45	4	907 001 213	9	



Q-RING PER FLANGE

RESISTENTE ALL'OLIO BIO / BIO OIL RESISTANT



**POLIURETANO
POLYURETHAN**



Misura Size	Ø interno inside Ø	Ø esterno outside Ø	Spessore Thickness	Confezione Box	Guarnizione Piatta in Poliuretano per Flange Flanges Polyurethan Flat Seal
Inch	mm	mm	mm	pz/pcs	Codice / Part. nr.
1/2"	25,60	3,8	3,5	10	993 210 000
3/4"	31,80	3,8	3,5	10	993 214 000
1"	39,80	3,8	3,5	10	993 219 000
1.1/4"	44,80	3,8	3,5	10	993 222 000
1.1/2"	54,30	3,8	3,5	5	993 225 000
2"	63,80	3,8	3,5	5	993 228 000

Misura Size	Guarnizione Piatta in Poliuretano per Flange Flanges Polyurethan Flat Seal	Assortimento (36 pz.) Assortiment (36 pcs.)
Inch	Codice / Part. nr.	Pz. / Pcs. Codice / Part. nr.
Kit per sollevare o-ring		5
1/2"	993 210 000	6
3/4"	993 214 000	8
1"	993 219 000	8
1.1/4"	993 222 000	8
1.1/2"	993 225 000	4
2"	993 228 000	2

993 000 001



UTENSILI SMONTAGGIO O-RING



Contenuto Set Set Contents	Utensili per Montaggio/Smontaggio O-Ring - Set di 2 pz. O-Ring Tools Set 2 pcs. Set	Utensili per Montaggio/Smontaggio O-Ring - Set di 5 pz. O-Ring Tools Set 5 pcs. Set
Inch	Codice / Part. nr.	Codice / Part. nr.
2	903 200 200	
5		903 300 300

MISURATORE O-RING



Cono Misuratore O-Ring e corde serie in pollici
Inch size O-Ring Measure Gauge

Codice / Part. nr.
903 999 000

MONTAGGIO GUARNIZIONI



Pinza Tre Becchi per Montaggio Guarnizioni
Three Support Gripper for Assembly Seals

Codice / Part. nr.
903 002 138

NBR (elastomero butadieneacrolonitrile)

- **Durezza:** 70 ÷ 80 ÷ 90 Shore.
- **Temperatura:** -30°C +100°C.
- **Caratteristiche:** resistenza agli oli, grassi minerali e vegetali, alcali, alcoli, gas, acqua, glicol, soluzioni saline, prodotti alimentari; resistenza relativa all'ozono.
- **Campi d'impiego:** costruzioni di macchine in genere, apparecchiature e pompe, dispositivi idraulici e pneumatici.
- **Prodotti:** o-ring, corda per o-ring, kit o-ring, Q-ring.

VITON - FPM (elastomero fluorurato)

- **Durezza:** 70 ÷ 90 Shore.
- **Temperatura:** -15°C +200°C.
- **Caratteristiche:** alta resistenza al calore ed eccezionale resistenza agli agenti chimici: oli, idrocarburi alifatici, diversi fluidi idraulici ininfiammabili.
- **Campi d'impiego:** costruzioni di apparecchiature chimiche di pompa per vuoto spinto, attrezzature idrauliche con fluidi ininfiammabili.
- **Prodotti:** o-ring, corda per o-ring, kit o-ring.

SILICONE (elastomero silicone)

- **Durezza:** 60 ÷ 80 Shore.
- **Temperatura:** -60°C +200°C.
- **Caratteristiche:** ampio campo di temperature; compatibilità con gli alimenti scarsa resistenza all'abrasione.
- **Campi d'impiego:** costruzioni di apparecchiature chimiche e macchine per industria alimentare.
- **Prodotti:** o-ring, corda per o-ring.

EPDM (elast. etilenepropilene reticolato)

- **Durezza:** 70 Shore.
- **Temperatura:** -40°C +160°C.
- **Caratteristiche:** buona resistenza all'acqua calda e vapore, all'invecchiamento ed agli agenti atmosferici. Non resistente agli oli ed ai grassi minerali.
- **Campi d'impiego:** rubinetteria per sanitari e riscaldamento, pompe, apparecchiature nucleari.
- **Prodotti:** o-ring, corda per o-ring.

CR 70 CR (elast. cloroprene, neoprene)

- **Durezza:** 70 Shore.
- **Temperatura:** -40°C +100°C.
- **Caratteristiche:** resistente agli agenti atmosferici ed all'invecchiamento, agli alcali, alcool, grassi, glicol, ozono e ai prodotti refrigeranti.
- **Campi d'impiego:** compressori frigoriferi e in condizioni atmosferiche.
- **Prodotti:** o-ring, corda per o-ring.

NBR (elastomer butadieneacrolonitrile)

- **Durometer:** 70 ÷ 80 ÷ 90 Shore.
- **Temperature range:** -30°C +100°C.
- **Main features:** resistance to the oils, mineral and vegetable fats, alkali, alcohol, gas, water, glycol, saline solutions, food products; resistance relative to the ozone.
- **Applications:** machines constructions generally, equipment and pumps, hydraulic and pneumatic devices.
- **Products:** o-ring, o-ring cord, kit o-ring, Q-ring.

VITON - FPM (elastomer fluorinated)

- **Durometer:** 70 ÷ 90 Shore.
- **Temperature range:** -15°C +200°C.
- **Main features:** high resistance to the heat and exceptional resistance to the chemical agents: oils, aliphatic hydrocarbons, unflammable hydraulic fluids.
- **Applications:** constructions of chemical equipment of pump for pushed gap, hydraulic equipment with unflammable fluids.
- **Products:** o-ring, o-ring cord, kit o-ring.

SILICONE (elastomer silicone)

- **Durometer:** 60 ÷ 80 Shore.
- **Temperature range:** -60°C +200°C.
- **Main features:** wide temperatures field; compatibility with the foods, resistance limited to the abrasion.
- **Applications:** constructions of chemical equipment and machines for alimentary industry.
- **Products:** o-ring, o-ring cord.

EPDM (elast. netting ethylenepropylene)

- **Durometer:** 70 Shore.
- **Temperature range:** -40°C +160°C.
- **Main features:** good resistance to the hot water and vapour, to the ageing and to atmospheric agents. Not resisting the oils and the mineral fats.
- **Applications:** taps and fittings for physicians and heating, pumps, nuclear equipment.
- **Products:** o-ring, o-ring cord.

CR 70 CR (elast. chloroprene, neoprene)

- **Durometer:** 70 Shore.
- **Temperature range:** -40°C +100°C.
- **Main features:** resisting the atmospheric agents and the ageing, the alkalis, alcohol, fats, glycol, ozone and to the refrigerant products.
- **Applications:** refrigerant compressors and in atmospheric conditions.
- **Products:** o-ring, o-ring cord.



ACCESSORI PER IL FISSAGGIO
FIXING ACCESSORIES

FASCETTE STRINGITUBO
PIPE/CABLE CLAMPS

CLASSE AUTOESTINGUENTE UL94V2
LINGUETTA IN NYLON
APPROVAZIONE RINA

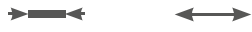

Larghezza Width	Lunghezza Length	Fascette di Cablaggio in Poliammide 6.6 - Colore Nero PA 6.6 Cables Ties - Black	Confezione Box
mm	mm	Codice / Part. nr.	pz/pcs
2,5	100	040 025 100	100
3,5	200	040 035 200	100
3,5	280	040 035 280	100
4,8	200	040 048 200	100
4,8	280	040 048 280	100
4,8	360	040 048 360	100
7,8	370	040 078 360	100
7,8	500	040 078 500	100



Larghezza Width	Lunghezza Length	Fascette di Cablaggio con Testa Sferica - Colore Nero Spherical Head Cables Ties - Black	Confezione Box
mm	mm	Codice / Part. nr.	pz/pcs
7,6	375	040 002 514	100



Larghezza Nastro Width of band	Campo di serraggio min./max. Min./max. grip range	Fascette Stringitubo ABA in acciaio al carbonio zincate ABA Clamps	Conf. Box	Larghezza Nastro Width of band	Campo di serraggio min./max. Min./max. grip range	Fascette Stringitubo NORMA in acciaio al carbonio zincate NORMA Clamps	Conf. Box
mm	mm	Codice / Part. nr.	pz/pcs	mm	mm	Codice / Part. nr.	pz/pcs
2,5	100	045 025 100	100	7,5	8x12	048 000 812	25
3,5	200	045 035 200	100	7,5	10x16	048 001 016	25
3,5	280	045 035 280	100	9	12x20	048 001 220	25
4,8	200	045 048 200	100	9	16x25	048 001 625	25
4,8	280	045 048 280	100	9	20x32	048 002 032	25
4,8	360	045 048 360	100	9	25x40	048 002 540	25
7,8	370	045 078 360	100	9	32x50	048 003 250	25
7,8	500	045 078 500	100	9	40x60	048 004 060	25
				9	50x70	048 005 070	25
				9	60x80	048 006 080	25
				9	70x80	048 007 090	25
				9	80x100	048 008 100	25
				9	90x110	048 009 110	25
				12	100x120	048 101 120	25

Assortimento Fascette Stringitubo Standard
Assortiment Standard Clamps

Assortimento (50 pz.)
Assortiment (50 pcs.)

Codice / Part. nr.	Pz. / Pcs.	Codice / Part. nr.
048 001 016	5	999 000 071
048 001 220	8	
048 001 625	10	
048 002 032	5	
048 002 540	12	
048 003 250	5	
048 004 060	5	



CARATTERISTICHE

- nastro a bordi rialzati per non danneggiare il tubo
- linguetta inferiore munita di rinforzo (con vite svitata il dado rimane in posizione)
- vite con testa esagonale
- adatta per tubi di piccolo diametro e spessore ridotto



Larghezza Nastro Width of band	Campo di serraggio min./max Min./max. grip range	Fascetta Mini in acciaio al carbonio zincata Galvanized Steel Mini Clamp	Conf. Box
mm	mm	Codice / Part. nr.	pz/pcs
9	6x8	540 080 009	10
9	7x9	540 090 009	10
9	8x10	540 100 009	10
9	9x11	● 540 110 009	10
9	10x12	540 120 009	10
9	11x13	540 130 009	10
9	12x14	● 540 140 009	10
9	13x15	540 150 009	10
9	14x16	● 540 160 009	10
9	15x17	● 540 170 009	10

CHARACTERISTICS

- features rolled-up band edges that are gentle on hoses
- the band tongue that fits under the hose is profiled for added strength (the nut remains in the lug even if the screw is removed)
- the screw has a slotted hexagonal head
- is particularly suitable for use on small, thin walled hoses

CARATTERISTICHE

- nastro acciaio zincato e acciaio INOX
- bullone e dado acciaio 8.8



Larghezza Nastro Width of band	Campo di serraggio min./max Min./max. grip range	Fascetta Super Rinforzata in acciaio al carbonio zincata Galvanized Steel Super Reinforced Clamp	Conf. Box	Fascetta Super Rinforzata in acciaio Inox AISI 316 AISI 316 Stainless Steel Super Reinforced Clamp	Conf. Box
mm	mm	Codice / Part. nr.	pz/pcs	Codice / Part. nr.	pz/pcs
18	17x19	● 046 017 019	10	● X46 017 019	1
18	20x22	046 020 022	10	● X46 020 022	1
18	23x25	046 023 025	10	● X46 023 025	1
18	26x28	046 026 028	10	● X46 026 028	1
20	29x31	046 029 031	10	● X46 029 031	1
20	32x35	046 032 035	10	● X46 032 035	1
20	36x39	046 036 039	10	● X46 036 039	1
20	40x43	046 040 043	10	● X46 040 043	1
22	44x47	046 044 047	10	● X46 044 047	1
22	48x51	046 048 051	10	● X46 048 051	1
22	52x55	046 052 055	10	● X46 052 055	1
22	56x59	046 056 059	4	● X46 056 059	1
22	60x63	046 060 063	4	● X46 060 063	1
22	64x67	046 064 067	4	● X46 064 067	1
24	68x73	● 046 068 073	4	● X46 068 073	1
24	74x79	● 046 074 079	4	● X46 074 079	1
24	80x85	● 046 080 085	4	● X46 080 085	1
24	86x91	046 086 091	4	● X46 086 091	1
24	92x97	● 046 092 097	4	● X46 092 097	1
24	98x103	● 046 098 103	4	● X46 098 103	1
24	104x112	046 104 112	4	● X46 104 112	1
24	113x121	046 113 121	4	● X46 113 121	1
24	122x130	046 122 130	4	● X46 122 130	1
26	131x139	● 046 131 139	4	● X46 131 139	1
26	140x148	● 046 140 148	4	● X46 140 148	1
26	149x161	● 046 149 161	4	● X46 149 161	1
26	162x174	● 046 162 174	4	● X46 162 174	1
26	175x187	● 046 175 187	4	● X46 175 187	1
26	188x200	● 046 188 200	4	● X46 188 200	1
26	201x213	● 046 201 213	4	● X46 201 213	1
26	214x227	● 046 214 227	4	● X46 214 227	1
26	228x239	● 046 228 239	4	● X46 228 239	1
26	240x252	● 046 240 252	4	● X46 240 252	1



Larghezza Width		Spessore Thickness	Confezione Box		Nastro di Chiusura in Inox AISI 201 AISI 201 Closure Tape		Sistema di Fissaggio Professionale Professional Fixing system	
Inch	mm	mm	pz/pcs	mt		Codice / Part. nr.		Codice / Part. nr.
3/8"	9,5	0,64	1	30,5	●	049 500 006	●	049 501 006
1/2"	12,7	0,76	1	30,5		049 500 008		049 501 008
5/8"	15,9	0,76	1	30,5	●	049 500 010	●	049 501 010
3/4"	19,1	0,76	1	30,5	●	049 500 012	●	049 501 012

Larghezza Width		Confezione Box		Nastro di Chiusura in Inox AISI 201 AISI 201 Closure Tape		Confezione Box		Utensile di Serraggio Standard Standard Chucking Tool	
Inch	mm	pz/pcs			Codice / Part. nr.	pz/pcs			Codice / Part. nr.
3/8"	9,5	100	●		049 502 006	1	●		049 503 001
1/2"	12,7	100			049 502 008				
5/8"	15,9	100	●		049 502 010				
3/4"	19,1	100	●		049 502 012				

MONTAGGIO

1. Scorrere il nastro dal rotolo. Inserire la graffa nel nastro con le orecchie rivolte verso l'installatore. Inserire l'estremità tonda del nastro dentro la graffa. Cingere l'oggetto e reinserirlo dentro la graffa. Si può rafforzare la tenuta ricingendo nuovamente l'oggetto creando un doppio nastro.
2. Inserire il nastro nell'alloggiamento dell'utensile e farlo scorrere. Con il pollice sulla leva del ferma nastro, stringere ruotando la manovella dell'utensile. Quando il nastro termina di scorrere attraverso la graffa, smettere di girare la maniglia.
3. Ruotare l'utensile sulla graffa in senso contrario e ruotare la maniglia di un giro.
4. Azionare la leva per tagliare il nastro. Rimuovere l'utensile. Premere il nastro tagliato tra le orecchie della graffa, poi battere con un martello e piegare le orecchie sul nastro per completare l'assemblaggio.



ASSEMBLY

1. Pull band from roll. Insert buckle on band, ears away from installer. Bend end of band under buckle. Encircle object bringing band through buckle again. You may double wrap for additional radial compression.
2. Insert band in tool nose slot and slide. With thumb on band gripper lever, tighten by turning tool handle. When band ceases moving through buckle, stop turning the handle.
3. Roll tool over buckle while reversing the handle one turn.
4. Pull handle to cut band. Remove the tool. Push band stub between the ears, then hammer completing the assembly.

● Fornibile in 7 gg lavorativi / Available in 7 working days

CARATTERISTICHE

- in acciaio AISI 304
- montaggio rapido e sicuro in pochi secondi
- alta resistenza alle pressioni
- L'anello di protezione interno impedisce un eventuale danneggiamento del tubo durante il serraggio
- Montaggio: Stringere con una tenaglia l'orecchia fino alla chiusura totale.

CHARACTERISTICS

- steel AISI 304
- safe and quick assembly in a few seconds
- high resistance to pressure
- The internal protection ring prevents a possible damage to the pipe during the tightening
- Mounting: Tighten the ear with pliers until the total closure.



Larghezza Nastro Width of band	Campo di serraggio min./max Min./max. grip range	Fascetta Mini in acciaio al carbonio zincata Galvanized Steel Mini Clamp	Conf. Box
mm	mm	Codice / Part. nr.	pz/pcs
5,5	2,5x2,9	● 049 025 029	10
5,5	2,9x3,7	● 049 029 037	10
5,5	3,7x4,7	● 049 037 047	10
5,5	4,7x5,7	● 049 047 057	10
6,4	5,6x6,5	● 049 056 065	10
6,4	6,3x7,5	● 049 063 075	10
7,4	7,5x9	● 049 075 090	10
7,4	9,1x10,8	● 049 091 108	10
7,4	10,3x12,3	● 049 103 123	10
8,2	11,3x13,3	● 049 113 133	10
8,2	12,3x14,3	● 049 123 143	10
8,2	13,1x15,3	● 049 131 153	10
8,2	13,9x16,1	● 049 139 161	10
8,2	14,6x16,8	● 049 146 168	10
8,2	15,6x17,8	● 049 156 178	10
9,2	17,1x19,3	● 049 171 193	4
9,2	18,8x21,1	● 049 188 211	4
9,2	19,2x21,8	● 049 192 218	4
9,2	21,0x23,8	● 049 210 238	4
9,2	23,0x25,6	● 049 230 256	4
9,2	23,3x26,3	● 049 233 263	4
9,2	26,5x30	● 049 265 300	4



Larghezza Nastro Width of band	Campo di serraggio min./max Min./max. grip range	Fascetta a 2 orecchie Two ear Hose Clip	Conf. Box
mm	mm	Codice / Part. nr.	pz/ pcs
5	3,4x5	● 050 034 050	10
6	5x7	● 050 050 070	10
7	7x9	● 050 070 090	10
7	8,8x11	● 050 088 110	10
7	10,8x13	● 050 108 130	10
7,5	12,5x15	● 050 125 150	10
8	14x17	● 050 140 170	10
8,5	16,2x20	● 050 162 200	10
9	18x22	● 050 180 220	10
9	19x23	● 050 190 230	10
10	21x25	● 050 210 250	4
10	24x28	● 050 240 280	4
10	27x31	● 050 270 310	4
10	29,3x34	● 050 293 340	4
10	32x37	● 050 320 370	4
10	35x40	● 050 350 400	4
10	37,6x43	● 050 376 430	4
10	40,6x46	● 050 406 460	4

CARATTERISTICHE

- in acciaio AISI 304
- montaggio rapido e sicuro in pochi secondi
- alta resistenza alle pressioni

MONTAGGIO

1. Stringere con una tenaglia una orecchia fino a metà.
2. Stringere l'altra orecchia fino alla chiusura totale.
3. Stringere la prima orecchia fino alla chiusura totale.

MONTAGGIO



SMONTAGGIO



CHARACTERISTICS

- steel AISI 304
- safe and quick assembly in a few seconds
- high resistance to pressure

ASSEMBLY

1. Tighten the ear with pliers halfway.
2. Tighten the other ear until the total closure.
3. Tighten the first ear until the total closure.



CARATTERISTICHE

- in acciaio inox AISI 304
- realizzate con doppio filo, ideali per serrare tubi aventi spirali in rilievo.
- garantiscono un serraggio eccellente anche su tubi morbidi con spessori sottili

MONTAGGIO

Stringere con un cacciavite fino alla chiusura totale.

CHARACTERISTICS

- AISI 304 stainless steel
- made with double thread, ideal for tightening hoses with embossed spirals.
- provide superior clamping even on soft tubes with thin walls

ASSEMBLY

Tighten with a screwdriver until the total closure.

Campo di Serraggio Grip range		Fascetta per Tubi con spirale in acciaio Inox AISI 321 AISI 321 Stainless Steel Wire Hose Clamp		Conf. Box
Min mm	Max mm	Codice / Part. nr.	pz/ pcs	
13,0	16,0	● 051 013 016	2	
15,0	18,0	● 051 015 018	2	
18,0	21,0	● 051 018 021	2	
20,0	23,0	● 051 020 023	2	
22,0	25,0	● 051 022 025	2	
24,0	27,0	● 051 024 027	2	
27,0	31,0	● 051 027 031	2	
31,0	35,0	● 051 031 035	2	
33,0	37,0	● 051 033 037	2	
35,0	40,0	● 051 035 040	2	
38,0	43,0	● 051 038 043	2	
43,0	48,0	● 051 043 048	2	
45,0	50,0	● 051 045 050	2	
49,0	55,0	● 051 049 055	2	
54,0	60,0	● 051 054 060	2	
59,0	65,0	● 051 059 065	2	
65,0	70,0	● 051 065 070	2	
70,0	75,0	● 051 070 075	2	
75,0	80,0	● 051 075 080	2	
80,0	85,0	● 051 080 085	2	
84,0	90,0	● 051 084 090	2	
92,0	100,0	● 051 092 100	2	
100,0	110,0	● 051 100 110	2	
105,0	115,0	● 051 105 115	2	
110,0	120,0	● 051 110 120	2	
115,0	125,0	● 051 115 125	2	
120,0	130,0	● 051 120 130	2	
130,0	140,0	● 051 130 140	2	
140,0	150,0	● 051 140 150	2	
153,0	160,0	● 051 153 160	2	
158,0	165,0	● 051 158 165	2	
163,0	170,0	● 051 163 170	2	
173,0	180,0	● 051 173 180	2	

FASCETTE STRINGITUBO

PIPE/CABLE CLAMPS

FASCETTE METALLO GOMMA



Larghezza Nastro Width of band	Diametro di serraggio Grip diameter	Fascetta Metallo Gomma Antivibrante NBR NBR Rubber Lined Clamp	Conf. Box
mm	mm	Codice / Part. nr.	pz/pcs
16	6	● 047 150 006	20
16	8	047 150 008	20
16	10	047 150 010	20
16	12	047 150 012	20
16	14	● 047 150 014	20
16	16	047 150 016	20
16	18	047 150 018	20
20	20	047 105 020	20
20	22	● 047 105 022	20
20	25	● 047 105 025	20
20	28	047 105 028	20
20	30	● 047 105 030	20
20	32	● 047 105 032	20
20	35	047 105 035	20
20	40	047 105 040	20
20	45	● 047 105 045	20
20	50	047 105 050	20
20	55	047 105 055	10
20	60	047 105 060	10
20	65	● 047 105 065	10
20	70	● 047 105 070	10
20	75	● 047 105 075	10
20	80	● 047 105 080	10
20	85	● 047 105 085	10
20	90	● 047 105 090	10
20	95	● 047 105 095	10
20	100	● 047 105 100	10
20	110	● 047 105 110	10
20	120	● 047 105 120	10

● Fornibile in 7 gg lavorativi / Available in 7 working days



TUBI RIGIDI E RACCORDI DIN
STEEL TUBES & DIN FITTINGS

TUBI PER CIRCUITI OLEODINAMICI
OLEODYNAMIC PLANTS TUBES



DESCRIZIONE

Tubi senza saldatura, trafilati a freddo, in acciaio **UNI EN 10305-4 E235N** normalizzati in atmosfera neutra. Esternamente zincati (Cr6 free), spessore minimo zinco 10 micron.

A richiesta fornibili anche in acciaio INOX.

DESCRIPTION

Seamless tubes, cold drawn, steel **UNI EN 10305-4 E235N** normalized in neutral atmosphere. Outside galvanized (Cr6 free), zinc minimum thickness of 10 microns.

On request also be supplied in stainless steel.



Tubo Circuiti Oleodinamici Zincato Zinc Plated Oleodynamic Plants	Ø Esterno O.D.	Spessore Thickness	Pr. Esercizio Max WP	Peso Weight	Lunghezza Length
Codice / Part. nr.	mm	mm	bar	Kg/mt	mt
100 604 100	4	1	540	0,074	6
100 606 100	6	1	360	0,123	6
100 606 150	6	1,5	540	0,166	6
100 608 100	8	1	270	0,173	6
100 608 150	8	1,5	405	0,240	6
100 610 100	10	1	216	0,222	6
100 610 150	10	1,5	324	0,314	6
100 610 200	10	2	432	0,395	6
100 612 100	12	1	180	0,271	6
100 612 150	12	1,5	270	0,388	6
100 612 200	12	2	360	0,493	6
100 614 100	14	1	154	0,321	6
100 614 150	14	1,5	231	0,462	6
100 614 200	14	2	308	0,592	6

CONTINUA NELLA PAGINA SUCCESSIVA / FOLLOW TO NEXT PAGE



● Fornibile in 7 gg lavorativi / Available in 7 working days



Tubo Circuiti Oleodinamici Zincato Zinc Plated Oleodynamic Plants	Ø Esterno O.D.	Spessore Thickness	Pr. Esercizio Max WP	Peso Weight	Lunghezza Length
Codice / Part. nr.	mm	mm	bar	Kg/mt	mt
100 615 100	15	1	144	0,345	6
100 615 150	15	1,5	216	0,499	6
100 615 200	15	2	288	0,641	6
100 616 150	16	1,5	202	0,536	6
100 616 200	16	2	270	0,690	6
100 616 250	16	2,5	337	0,832	6
100 618 100	18	1	120	0,419	6
100 618 150	18	1,5	180	0,610	6
100 618 200	18	2	240	0,789	6
100 618 250	18	2,5	300	0,956	6
100 620 200	20	2	216	0,888	6
100 620 250	20	2,5	270	1,079	6
100 620 300	20	3	324	1,258	6
100 622 150	22	1,5	147	0,758	6
100 622 200	22	2	196	0,986	6
100 622 250	22	2,5	245	1,200	6
100 622 300	22	3	294	1,406	6
100 625 150	25	1,5	129	0,869	6
100 625 200	25	2	173	1,134	6
100 625 250	25	2,5	216	1,387	6
100 625 300	25	3	259	1,628	6
100 628 150	28	1,5	115	0,980	6
100 628 200	28	2	154	1,282	6
100 628 250	28	2,5	192	1,600	6
100 628 300	28	3	231	1,850	6
100 630 250	30	2,5	176	1,695	6
100 630 300	30	3	216	1,997	6
100 630 400	30	4	288	2,565	6
100 635 200	35	2	123	1,628	6
100 635 250	35	2,5	120	2,004	6
100 635 300	35	3	185	2,367	6
100 638 400	38	4	227	3,354	6
100 642 200	42	2	103	1,973	6
100 642 300	42	3	154	2,885	6

● Fornibile in 7 gg lavorativi / Available in 7 working days



TUBI RIGIDI E RACCORDI DIN
STEEL TUBES & DIN FITTINGS

RACCORDI AD ANELLO TAGLIANTE DIN 2353
DIN 2353 FITTINGS
WITH EDGE CUTTING RING

DIN 81



DADI

BUSSOLE RINFORZO

DIN 80



Serie Series	Ø Esterno O.D.	Filetto Thread	Pr. Esercizio Max WP bar	Dado di Serraggio Nut		Ø Esterno O.D.	Spessore Thickness mm	Bussola di Rinforzo Pipe Insert	
	mm	mm		Codice / Part. nr.	Codice / Part. nr.			mm	mm
LL	4 LL	M 8x1	100	•*	581 000 001	4 LL	M 8x1	•	580 000 013
LL	5 LL	M 10x1	100	•*	581 000 002	5 LL	M 10x1	•	580 000 001
LL	6 LL	M 10x1	100	*	581 000 003	6 LL	M 10x1	•	580 000 002
LL	8 LL	M 12x1	100	*	581 000 004	8 LL	M 12x1	•	580 000 003
LL	10 LL	M 14x1	100	*	581 000 005	10 LL	M 14x1	•	580 000 014
LL	12 LL	M 16x1	100	•*	581 000 006	12 LL	M 16x1	•	580 000 004
L	6 L	M 12x1,5	500	*	581 000 007	6 L	M 12x1,5	•	580 000 015
L	8 L	M 14x1,5	500	*	581 000 008	8 L	M 14x1,5	•	580 000 016
L	10 L	M 16x1,5	500	*	581 000 009	10 L	M 16x1,5	•	580 000 005
L	12 L	M 18x1,5	400	*	581 000 010	12 L	M 18x1,5	•	580 000 017
L	15 L	M 22x1,5	400	*	581 000 011	15 L	M 22x1,5	•	580 000 006
L	18 L	M 26x1,5	400	*	581 000 012	18 L	M 26x1,5	•	580 000 007
L	22 L	M 30x2	250	*	581 000 013	22 L	M 30x2	•	580 000 018
L	28 L	M 36x2	250	*	581 000 014	28 L	M 36x2	•	580 000 008
L	35 L	M 45x2	250	*	581 000 015	35 L	M 45x2	•	580 000 009
L	42 L	M 52x2	250	*	581 000 016	42 L	M 52x2	•	580 000 010
S	6 S	M 14x1,5	630	*	581 000 017	6 S	M 14x1,5	•	580 000 019
S	8 S	M 16x1,5	630	*	581 000 018	8 S	M 16x1,5	•	580 000 011
S	10 S	M 18x1,5	630	*	581 000 019	10 S	M 18x1,5	•	580 000 012
S	12 S	M 20x1,5	630	*	581 000 020	12 S	M 20x1,5		
S	14 S	M 22x1,5	630	*	581 000 021	14 S	M 22x1,5		
S	16 S	M 24x1,5	420	*	581 000 022	16 S	M 24x1,5		
S	20 S	M 30x2	420	*	581 000 023	20 S	M 30x2		
S	25 S	M 36x2	420	*	581 000 024	25 S	M 36x2		
S	30 S	M 42x2	420	*	581 000 025	30 S	M 42x2		
S	38 S	M 52x2	315	*	581 000 026	38 S	M 52x2		

• Fornibile in 7 gg lavorativi / Available in 7 working days

* Fornibile anche in Acciaio Inox / Also Stainless Steel available

DIN 88



AR3C



LL7



Serie Series	Pr. Esercizio Max WP bar	Ø Esterno O.D. mm	Anello ad incisione Cutting Ring		Anello ad Incisione Tenuta Elastomerica Elastomeric Clamping Cutting Ring		Anello in viton Anti Trafilamento Viton Ring for Leakage	
			Codice / Part. nr.	Codice / Part. nr.	Codice / Part. nr.	Codice / Part. nr.		
LL	100	4 LL	•	588 000 001				
LL	100	5 LL	•	588 000 002				
LL	100	6 LL		588 000 003				
LL	100	8 LL		588 000 004				
LL	100	10 LL		588 000 005				
LL	100	12 LL	•	588 000 006				
L	630	6 L		588 000 007	•	588 100 007	•	588 001 007
L	630	8 L		588 000 008	•	588 100 008	•	588 001 008
L	630	10 L		588 000 009	•	588 100 009	•	588 001 009
L	630	12 L		588 000 010	•	588 100 010	•	588 001 010
L	400	15 L		588 000 011	•	588 100 011	•	588 001 011
L	400	18 L		588 000 012	•	588 100 012	•	588 001 012
L	250	22 L		588 000 013	•	588 100 013	•	588 001 013
L	250	28 L		588 000 014	•	588 100 014	•	588 001 014
L	250	35 L		588 000 015	•	588 100 015	•	588 001 015
L	250	42 L		588 000 016	•	588 100 016	•	588 001 016
S	630	6 S		588 000 007	•	588 100 007	•	588 001 007
S	630	8 S		588 000 008	•	588 100 008	•	588 001 008
S	630	10 S		588 000 009	•	588 100 009	•	588 001 009
S	630	12 S		588 000 010	•	588 100 010	•	588 001 010
S	630	14 S		588 000 017	•	588 100 017	•	588 001 017
S	420	16 S		588 000 018	•	588 100 018	•	588 001 018
S	420	20 S		588 000 019	•	588 100 019	•	588 001 019
S	420	25 S		588 000 020	•	588 100 020	•	588 001 020
S	420	30 S		588 000 021	•	588 100 021	•	588 001 021
S	315	38 S		588 000 022	•	588 100 022	•	588 001 022

• Fornibile in 7 gg lavorativi / Available in 7 working days



DIN 92GG R



DIN 93 R



FILETTO GAS
CILINDRICO/CONICO

Serie Series	Ø Esterno O.D.	Filetto Thread	Pr. Esercizio Max WP	Diritto di Estremità Gas cilindrico con Guarnizione Piana Straight Male Stud Couplings BSP with captive Seal		Pr. Esercizio Max WP	Diritto di Estremità Gas conico Straight Male Stud Couplings BSPT	
				Codice / Part. nr.	Codice / Part. nr.			
	mm	Inch	bar			bar		
LL	4 LL	G 1/8"-28				100	*	593 000 001
LL	5 LL	G 1/8"-28				100	●*	593 000 002
LL	6 LL	G 1/8"-28				100	*	593 000 003
LL	8 LL	G 1/8"-28				100	*	593 000 004
LL	8 LL	G 1/4"-19				100	●*	593 000 027
LL	10 LL	G 1/4"-19				100	●*	593 000 005
LL	12 LL	G 1/4"-19				100	●*	593 000 006
LL	12 LL	G 3/8"-19				100	●*	593 000 028
L	6 L	G 1/8"-28	500	*	592 002 001	315	●*	593 000 007
L	6 L	G 1/4"-19	500	*	592 002 021	315	●*	593 000 029
L	6 L	G 3/8"-19	500	*	592 002 022		*	
L	8 L	G 1/8"-28	500	*	592 002 023	315	●*	593 000 030
L	8 L	G 1/4"-19	500	*	592 002 002	315	*	593 000 008
L	8 L	G 3/8"-19	400	*	592 002 024	315	●*	593 000 031
L	8 L	G 1/2"-14	400	*	592 002 025	315	●*	593 000 032
L	10 L	G 1/8"-28	500	*	592 002 026	315	●*	593 000 033
L	10 L	G 1/4"-19	500	*	592 002 003	315	*	593 000 009
L	10 L	G 3/8"-19	400	*	592 002 027	315	*	593 000 034
L	10 L	G 1/2"-14	400	*	592 002 028	315	●*	593 000 035
L	12 L	G 1/4"-19	400	*	592 002 029	315	●*	593 000 036
L	12 L	G 3/8"-19	400	*	592 002 004	315	*	593 000 010
L	12 L	G 1/2"-14	400	*	592 002 030	315	●*	593 000 037
L	15 L	G 3/8"-19	400	*	592 002 031	315	*	593 000 038
L	15 L	G 1/2"-14	400	*	592 002 005	315	●*	593 000 011
L	15 L	G 3/4"-14	250	*	592 002 032		*	
L	18 L	G 3/8"-19	400	*	592 002 050	315	●*	593 000 039
L	18 L	G 1/2"-14	400	*	592 002 006	315	●*	593 000 012
L	18 L	G 3/4"-14	250	*	592 002 033	315	●*	593 000 040
L	22 L	G 1/2"-14	250	*	592 002 034			

CONTINUA NELLA PAGINA SUCCESSIVA / FOLLOW TO NEXT PAGE



DIN 92GG R



DIN 93 R



FILETTO GAS
CILINDRICO/CONICO

Serie Series	Ø Esterno O.D.	Filetto Thread	Pr. Esercizio Max WP	Diritto di Estremità Gas cilindrico con Guarnizione Piana Straight Male Stud Couplings BSP with captive Seal		Pr. Esercizio Max WP	Diritto di Estremità Gas conico Straight Male Stud Couplings BSPT	
				Codice / Part. nr.	Codice / Part. nr.			
	mm	Inch	bar			bar		
L	22 L	G 3/4"-14	250	*	592 002 007	160	*	593 000 013
L	22 L	G 1"-11	250	*	592 002 035			
L	28 L	G 3/4"-14	250	*	592 002 036			
L	28 L	G 1"-11	250	*	592 002 008	160	●*	593 000 014
L	35 L	G 1"-11	250	●*	592 002 037	160	●*	593 000 041
L	35 L	G 1.1/4"-11	250	*	592 002 009	160	●*	593 000 015
L	42 L	G 1.1/2"-11	250	*	592 002 010	160	●*	593 000 016
S	6 S	G 1/4"-19	630	*	592 002 011	400	*	593 000 017
S	8 S	G 1/4"-19	630	*	592 002 012	400	●*	593 000 018
S	8 S	G 3/8"-19	630	*	592 002 038			
S	10 S	G 1/4"-19	630	*	592 002 039	400	●*	593 000 042
S	10 S	G 3/8"-19	630	*	592 002 013	400	●*	593 000 019
S	10 S	G 1/2"-14	630	●*	592 002 040			
S	12 S	G 1/4"-19	630	*	592 002 041	400	●*	593 000 043
S	12 S	G 3/8"-19	630	*	592 002 014	400	●*	593 000 020
S	12 S	G 1/2"-14	630	*	592 002 042	400	●*	593 000 044
S	14 S	G 3/8"-19	630	*	592 002 043	400	●*	593 000 045
S	14 S	G 1/2"-14	630	*	592 002 015	400	●*	593 000 021
S	16 S	G 3/8"-19	420	*	592 002 044	400	●*	593 000 046
S	16 S	G 1/2"-14	420	*	592 002 016	400	*	593 000 022
S	16 S	G 3/4"-14	420	●*	592 002 045			
S	20 S	G 1/2"-14	420	*	592 002 046			
S	20 S	G 3/4"-14	420	*	592 002 017	400	*	593 000 023
S	25 S	G 3/4"-14	420	*	592 002 047			
S	25 S	G 1"-11	420	*	592 002 018	250	●*	593 000 024
S	30 S	G 1"-11	420	*	592 002 048	160	●*	593 000 047
S	30 S	G 1.1/4"-11	420	*	592 002 019	160	●*	593 000 025
S	38 S	G 1.1/4"-11	315	*	592 002 049	160	●*	593 000 048
S	38 S	G 1.1/2"-11	315	*	592 002 020	160	●*	593 000 026

RACCORDI AD ANELLO DIN 2353

DIN 2353 CUTTING RING FITTINGS

RACCORDI DI ESTREMITÀ BSP SVASATI 60°



DIN 92 SV



FILETTO GAS CILINDRICO

Serie Series	Ø Esterno O.D.	Filetto Thread	Pr. Esercizio Max WP	Diritto di Estremità Gas cilindrico svasato a 60° Straight Male Stud Couplings BSP 60° cone	
				bar	Codice / Part. nr.
L	6 L	G 1/8"-28	500	●	592 100 002
L	6 L	G 1/4"-19	500	●	592 100 022
L	8 L	G 1/8"-28	500	●	592 100 025
L	8 L	G 1/4"-19	500	●	592 100 003
L	8 L	G 3/8"-19	400	●	592 100 026
L	10 L	G 1/4"-19	500	●	592 100 004
L	10 L	G 3/8"-19	400	●	592 100 029
L	10 L	G 1/2"-14	400	●	592 100 030
L	12 L	G 1/4"-19	400	●	592 100 031
L	12 L	G 3/8"-19	400	●	592 100 005
L	12 L	G 1/2"-14	400	●	592 100 032
L	15 L	G 3/8"-19	400	●	592 100 033
L	15 L	G 1/2"-14	400	●	592 100 006
L	18 L	G 1/2"-14	400	●	592 100 007
L	22 L	G 3/4"-14	250	●	592 100 008
L	28 L	G 3/4"-14	250	●	592 100 040
L	28 L	G 1"-11	250	●	592 100 009
L	35 L	G 1.1/4"-11	250	●	592 100 010
L	42 L	G 1.1/2"-11	250	●	592 100 011
S	6 S	G 1/4"-19	630	●	592 100 012
S	8 S	G 1/4"-19	630	●	592 100 013
S	10 S	G 1/4"-19	630	●	592 100 044
S	10 S	G 3/8"-19	630	●	592 100 014
S	10 S	G 1/2"-14	630	●	592 100 045
S	12 S	G 3/8"-19	630	●	592 100 015
S	12 S	G 1/2"-14	630	●	592 100 047
S	14 S	G 1/2"-14	630	●	592 100 016
S	16 S	G 1/2"-14	420	●	592 100 017
S	16 S	G 3/4"-14	420	●	592 100 050
S	20 S	G 3/4"-14	420	●	592 100 018
S	25 S	G 1"-11	420	●	592 100 019
S	30 S	G 1.1/4"-11	420	●	592 100 020
S	38 S	G 1.1/2"-11	315	●	592 100 021

● Fornibile in 7 gg lavorativi / Available in 7 working days

RACCORDI AD ANELLO DIN 2353

DIN 2353 CUTTING RING FITTINGS

RACCORDI DI ESTREMITÀ METRICI



DIN 92GG M



FILETTO GAS METRICO

Serie Series	Ø Esterno O.D.	Filetto Thread	Pr. Esercizio Max WP	Diritto di Estremità Metrico con Guarnizione Straight Male Stud Couplings Metric with Seal		Pr. Esercizio Max WP	Diritto di Estremità Metrico conico Straight Male Stud Couplings Metric tapered	
				bar	Codice / Part. nr.		bar	Codice / Part. nr.
LL	4 LL	M 8x1				100	●*	593 002 001
LL	5 LL	M 8x1				100	●*	593 002 002
LL	6 LL	M 10x1				100	●*	593 002 003
LL	8 LL	M 10x1				100	●*	593 002 004
L	6 L	M 10x1	500	●*	592 003 001	315	●*	593 002 005
L	8 L	M 12x1,5	500	●*	592 003 002	315	●*	593 002 006
L	10 L	M 14x1,5	400	●*	592 003 003	315	●*	593 002 007
L	10 L	M 16x1,5	400	●*	592 003 021			
L	10 L	M 18x1,5	400	●*	592 003 022			
L	12 L	M 14x1,5	400	●*	592 003 024			
L	12 L	M 16x1,5	400	●*	592 003 004	315	●*	593 002 008
L	12 L	M 18x1,5	400	●*	592 003 025			
L	12 L	M 22x1,5	400	●*	592 003 026			
L	15 L	M 16x1,5	400	●*	592 003 027			
L	15 L	M 18x1,5	400	●*	592 003 005	250	●*	593 002 009
L	15 L	M 22x1,5	400	●*	592 003 028			
L	18 L	M 18x1,5	400	●*	592 003 029			
L	18 L	M 22x1,5	400	●*	592 003 006	250	●*	593 002 010
L	22 L	M 22x1,5	250	●*	592 003 030			
L	22 L	M 26x1,5	250	●*	592 003 007	160	●*	593 002 011
L	28 L	M 33x2	250	●*	592 003 008	160	●*	593 002 012
L	35 L	M 42x2	250	●*	592 003 009	160	●*	593 002 013
L	42 L	M 48x2	250	●*	592 003 010	160	●*	593 002 014
S	6 S	M 12x1,5	630	●*	592 003 011	400	●*	593 002 015
S	8 S	M 14x1,5	630	●*	592 003 012	400	●*	593 002 016
S	10 S	M 16x1,5	630	●*	592 003 013	400	●*	593 002 017
S	12 S	M 18x1,5	630	●*	592 003 014	400	●*	593 002 018
S	12 S	M 22x1,5	630	●*	592 003 031			
S	14 S	M 20x1,5	630	●*	592 003 015	400	●*	593 002 019
S	16 S	M 18x1,5	420	●*	592 003 032			
S	16 S	M 22x1,5	420	●*	592 003 016	400	●*	593 002 020
S	20 S	M 27x2	420	●*	592 003 017	400	●*	593 002 021
S	25 S	M 33x2	420	●*	592 003 018	250	●*	593 002 022
S	30 S	M 42x2	420	●*	592 003 019	160	●*	593 002 023
S	38 S	M 48x2	315	●*	592 003 020	160	●*	593 002 024

● Fornibile in 7 gg lavorativi / Available in 7 working days

* Fornibile anche in Acciaio Inox / Also Stainless Steel available



**FILETTO GAS
CILINDRICO/CONICO**



Serie Series	Ø Esterno O.D.	Filetto Thread	Pr. Esercizio Max WP	Gomito di Estremità Gas cilindrico Male Stud Elbow CouplingsBSP	Pr. Esercizio Max WP	Gomito di Estremità Gas conico Male Stud Elbow Couplings BSPT	
				Codice / Part. nr.		Codice / Part. nr.	
	mm	Inch	bar		bar		
LL	4 LL	G 1/8"-28			100	●*	594 001 001
LL	5 LL	G 1/8"-28			100	●*	594 001 002
LL	6 LL	G 1/8"-28			100	*	594 001 003
LL	8 LL	G 1/8"-28			100	*	594 001 004
LL	10 LL	G 1/4"-19			100	*	594 001 005
LL	12 LL	G 1/4"-19			100	*	594 001 006
L	6 L	G 1/8"-28			315	*	594 001 007
L	6 L	G 1/4"-19			315	*	594 001 027
L	8 L	G 1/8"-28			315	*	594 001 008
L	8 L	G 1/4"-19			315	●*	594 001 028
L	8 L	G 3/8"-19			315	●*	594 001 029
L	10 L	G 1/4"-19			315	*	594 001 009
L	10 L	G 3/8"-19			315	*	594 001 030
L	10 L	G 1/2"-14			315	●*	594 001 031
L	12 L	G 1/4"-19			315	●*	594 001 032
L	12 L	G 3/8"-19			315	*	594 001 010
L	12 L	G 1/2"-14			315	*	594 001 033
L	15 L	G 3/8"-19			315	●*	594 001 034
L	15 L	G 1/2"-14			315	*	594 001 011
L	18 L	G 1/2"-14			315	*	594 001 012
L	18 L	G 3/4"-14			315	*	594 001 035
L	22 L	G 3/4"-14	160	●	160	*	594 001 013
L	28 L	G 1"-11	160	●	160	*	594 001 014
L	35 L	G 1.1/4"-11	160	●	160	●*	594 001 015
L	42 L	G 1.1/2"-11	160	●	160	●*	594 001 016

CONTINUA NELLA PAGINA SUCCESSIVA / FOLLOW TO NEXT PAGE



**FILETTO GAS
CILINDRICO/CONICO**



Serie Series	Ø Esterno O.D.	Filetto Thread	Pr. Esercizio Max WP	Gomito di Estremità Gas cilindrico Male Stud Elbow CouplingsBSP	Pr. Esercizio Max WP	Gomito di Estremità Gas conico Male Stud Elbow Couplings BSPT	
				Codice / Part. nr.		Codice / Part. nr.	
	mm	Inch	bar		bar		
S	6 S	G 1/4"-19			400	*	594 001 017
S	8 S	G 1/4"-19			400	●*	594 001 018
S	10 S	G 3/8"-19			400	*	594 001 019
S	12 S	G 3/8"-19			400	*	594 001 020
S	12 S	G 1/2"-14			400	●*	594 001 036
S	14 S	G 1/2"-14			400	*	594 001 021
S	16 S	G 3/8"-19			400	●*	594 001 037
S	16 S	G 1/2"-14			400	*	594 001 022
S	20 S	G 1/2"-14			400	●*	594 001 039
S	20 S	G 3/4"-14	400	●	400	*	594 001 023
S	25 S	G 1"-11	400	●	250	*	594 001 024
S	30 S	G 1"-11			160	●*	594 001 040
S	30 S	G 1.1/4"-11	400	●	160	*	594 001 025
S	38 S	G 1.1/2"-11	315	●	160	●*	594 001 026

RACCORDI AD ANELLO DIN 2353

DIN 2353 CUTTING RING FITTINGS

RACCORDI DI ESTREMITÀ A GOMITO METRICI



FILETTO GAS CILINDRICO/CONICO



DIN 95 M



DIN 94 M

Serie Series	Ø Esterno O.D.	Filetto Thread	Pr. Esercizio Max WP	Gomito di Estremità Metrico cilindrico Male Stud Elbow Couplings Metric	Pr. Esercizio Max WP	Gomito di Estremità Metrico conico Male Stud Elbow Couplings Metric
	mm	mm	bar	Codice / Part. nr.	bar	Codice / Part. nr.
LL	4 LL	M 8x1			100	•* 594 000 001
LL	5 LL	M 8x1			100	•* 594 000 002
LL	6 LL	M 10x1			100	•* 594 000 003
LL	8 LL	M 10x1			100	•* 594 000 004
L	6 L	M 10x1			315	•* 594 000 005
L	8 L	M 12x1,5			315	•* 594 000 006
L	10 L	M 14x1,5			315	•* 594 000 007
L	12 L	M 16x1,5			315	•* 594 000 008
L	15 L	M 18x1,5			315	•* 594 000 009
L	18 L	M 22x1,5			315	•* 594 000 010
L	22 L	M 26x1,5	160	•		595 001 001
L	28 L	M 33x2	160	•		595 001 002
L	35 L	M 42x2	160	•		595 001 003
L	42 L	M 48x2	160	•		595 001 004
S	6 S	M 12x1,5			400	•* 594 000 011
S	8 S	M 14x1,5			400	•* 594 000 012
S	10 S	M 16x1,5			400	•* 594 000 013
S	12 S	M 18x1,5			400	•* 594 000 014
S	14 S	M 20x1,5			400	•* 594 000 015
S	16 S	M 22x1,5			400	•* 594 000 016
S	20 S	M 27x2	160	•		595 001 005
S	25 S	M 33x2	160	•		595 001 006
S	30 S	M 42x2	160	•		595 001 007
S	38 S	M 48x2	160	•		595 001 008

RACCORDI AD ANELLO DIN 2353

DIN 2353 CUTTING RING FITTINGS

RACCORDI DI ESTREMITÀ A TEE BSP/METRICI



FILETTO GAS CILINDRICO/CONICO



DIN 97 R



DIN 129 R

Serie Series	Ø Esterno O.D.	Filetto Thread	Pr. Esercizio Max WP	TEE di Estremità centrale Gas cilindrico Male Stud TEE central Couplings BSP	Pr. Esercizio Max WP	TEE di Estremità laterale Gas cilindrico Male Stud TEE lateral Couplings BSP
	mm	Inch	bar	Codice / Part. nr.	bar	Codice / Part. nr.
L	22 L	G 3/4"-14	160	•	160	• 512 901 001
L	28 L	G 1"-11	160	•	160	• 512 901 002
L	35 L	G 1.1/4"-11	160	•	160	• 512 901 003
L	42 L	G 1.1/2"-11	160	•	160	• 512 901 004
S	20 S	G 3/4"-14	400	•	400	• 512 901 005
S	25 S	G 1"-11	400	•	400	• 512 901 006
S	30 S	G 1"-11	250	•	250	• 512 901 007
S	38 S	G 1.1/2"-11	250	•	250	• 512 901 008

FILETTO GAS CILINDRICO/CONICO



DIN 97 M



DIN 129 M

Serie Series	Ø Esterno O.D.	Filetto Thread	Pr. Esercizio Max WP	TEE di Estremità centrale Metrico cilindrico Male Stud TEE central Couplings Metric	Pr. Esercizio Max WP	TEE di Estremità laterale Metrico cilindrico Male Stud TEE lateral Couplings Metric
	mm	Inch	bar	Codice / Part. nr.	bar	Codice / Part. nr.
L	22 L	M 26x1,5	160	•	160	• 512 900 001
L	28 L	M 33x2	160	•	160	• 512 900 002
L	35 L	M 42x2	160	•	160	• 512 900 003
L	42 L	M 48x2	160	•	160	• 512 900 004
S	20 S	M 27x2	400	•	400	• 512 900 005
S	25 S	M 33x2	400	•	400	• 512 900 006
S	30 S	M 42x2	250	•	250	• 512 900 007
S	38 S	M 48x2	250	•	250	• 512 900 008



DIN 96 R



DIN 127 R

**FILETTO
GAS CONICO**

Serie Series	Ø Esterno O.D.	Filetto Thread	Pr. Esercizio Max WP	TEE di Estremità centrale Gas conico Male Stud TEE central Couplings BSPT		TEE di Estremità laterale Gas conico Male Stud TEE lateral Couplings BSPT	
				Codice / Part. nr.	Pr. Esercizio Max WP	Codice / Part. nr.	Pr. Esercizio Max WP
	mm	Inch	bar	●	Codice / Part. nr.	bar	●
LL	4 LL	G 1/8"-28	100	●	596 000 001	100	●
LL	5 LL	G 1/8"-28	100	●	596 000 002	100	●
LL	6 LL	G 1/8"-28	100	●	596 000 003	100	●
LL	8 LL	G 1/8"-28	100	●	596 000 004	100	●
LL	10 LL	G 1/4"-19	100	●	596 000 005	100	●
LL	12 LL	G 1/4"-19	100	●	596 000 006	100	●
L	6 L	G 1/8"-28	315	●	596 000 007	315	●
L	8 L	G 1/4"-19	315	●	596 000 008	315	●
L	10 L	G 1/4"-19	315	●	596 000 009	315	●
L	12 L	G 3/8"-19	315	●	596 000 010	315	●
L	15 L	G 1/2"-14	315	●	596 000 011	315	●
L	18 L	G 1/2"-14	315	●	596 000 012	315	●
L	22 L	G 3/4"-14	160	●	596 000 013	160	●
L	28 L	G 1"-11	160	●	596 000 014	160	●
L	35 L	G 1.1/4"-11	160	●	596 000 015	160	●
L	42 L	G 1.1/2"-11	160	●	596 000 016	160	●
S	6 S	G 1/4"-19	630	●	596 000 017	630	●
S	8 S	G 1/4"-19	630	●	596 000 018	630	●
S	10 S	G 3/8"-19	630	●	596 000 019	630	●
S	12 S	G 3/8"-19	630	●	596 000 020	630	●
S	14 S	G 1/2"-14	630	●	596 000 021	630	●
S	16 S	G 1/2"-14	400	●	596 000 022	400	●
S	20 S	G 3/4"-14	400	●	596 000 023	400	●
S	25 S	G 1"-11	400	●	596 000 024	400	●
S	30 S	G 1.1/4"-11	400	●	596 000 025	400	●
S	38 S	G 1.1/2"-11	315	●	596 000 026	315	●

● Fornibile in 7 gg lavorativi / Available in 7 working days



DIN 96 M



DIN 127 M

**FILETTO
GAS CONICO**

Serie Series	Ø Esterno O.D.	Filetto Thread	Pr. Esercizio Max WP	TEE di Estremità centrale Metrico conico Male Stud TEE central Couplings Metric tapered		TEE di Estremità laterale Metrico conico Male Stud TEE lateral Couplings Metric tapered	
				Codice / Part. nr.	Pr. Esercizio Max WP	Codice / Part. nr.	Pr. Esercizio Max WP
	mm	mm	bar	●	Codice / Part. nr.	bar	●
LL	4 LL	M 8x1	100	●	596 001 001	100	●
LL	5 LL	M 8x1	100	●	596 001 002	100	●
LL	6 LL	M 10x1	100	●	596 001 003	100	●
LL	8 LL	M 10x1	100	●	596 001 004	100	●
L	6 L	M 10x1	315	●	596 001 005	315	●
L	8 L	M 12x1,5	315	●	596 001 006	315	●
L	10 L	M 14x1,5	315	●	596 001 007	315	●
L	12 L	M 16x1,5	315	●	596 001 008	315	●
L	15 L	M 18x1,5	315	●	596 001 009	315	●
L	18 L	M 22x1,5	315	●	596 001 010	315	●
S	6 S	M 12x1,5	630	●	596 001 011	630	●
S	8 S	M 14x1,5	630	●	596 001 012	630	●
S	10 S	M 16x1,5	630	●	596 001 013	630	●
S	12 S	M 18x1,5	630	●	596 001 014	630	●
S	14 S	M 20x1,5	630	●	596 001 015	630	●
S	16 S	M 22x1,5	400	●	596 001 016	400	●

● Fornibile in 7 gg lavorativi / Available in 7 working days



DIN 98



DIN 99



INTERMEDIO

Serie Series	Ø Esterno O.D.	Pr. Esercizio Max WP		Intermedio Diritto Straight Coupling	Pr. Esercizio Max WP		Intermedio a Gomito Equal Elbow
		mm	bar	Codice / Part. nr.	bar	Codice / Part. nr.	
LL	4 LL	100	*	598 001 001	100	•*	599 000 001
LL	5 LL	100	*	598 001 002	100	•*	599 000 002
LL	6 LL	100	*	598 001 003	100	•*	599 000 003
LL	8 LL	100	*	598 001 004	100	•*	599 000 004
LL	10 LL	100	*	598 001 005	100	•*	599 000 005
LL	12 LL	100	*	598 001 006	100	•*	599 000 006
L	6 L	500	*	598 001 007	500	*	599 000 007
L	8 L	500	*	598 001 008	500	*	599 000 008
L	10 L	500	*	598 001 009	315	*	599 000 009
L	12 L	400	*	598 001 010	315	*	599 000 010
L	15 L	400	*	598 001 011	315	*	599 000 011
L	18 L	400	*	598 001 012	315	*	599 000 012
L	22 L	250	*	598 001 013	250	*	599 000 013
L	28 L	250	*	598 001 014	250	*	599 000 014
L	35 L	250	*	598 001 015	160	*	599 000 015
L	42 L	250	*	598 001 016	160	•*	599 000 016
S	6 S	630	*	598 001 017	630	•*	599 000 017
S	8 S	630	*	598 001 018	630	*	599 000 018
S	10 S	630	*	598 001 019	630	*	599 000 019
S	12 S	630	*	598 001 020	630	*	599 000 020
S	14 S	630	*	598 001 021	630	*	599 000 021
S	16 S	420	*	598 001 022	420	*	599 000 022
S	20 S	420	*	598 001 023	420	*	599 000 023
S	25 S	420	*	598 001 024	420	*	599 000 024
S	30 S	420	*	598 001 025	400	*	599 000 025
S	38 S	315	*	598 001 026	315	*	599 000 026



DIN 100



DIN 101



INTERMEDIO

Serie Series	Ø Esterno O.D.	Pr. Esercizio Max WP		Intermedio a TEE Equal TEE	Pr. Esercizio Max WP		Intermedio a Croce Equal Crosses
		mm	bar	Codice / Part. nr.	bar	Codice / Part. nr.	
LL	4 LL	100	•*	510 000 001	100	•	510 101 001
LL	5 LL	100	•*	510 000 002	100	•	510 101 002
LL	6 LL	100	•*	510 000 003	100	•	510 101 003
LL	8 LL	100	•*	510 000 004	100	•	510 101 004
LL	10 LL	100	•*	510 000 005			
LL	12 LL	100	•*	510 000 006			
L	6 L	500	*	510 000 007	315	•	510 101 005
L	8 L	500	*	510 000 008	315	•	510 101 006
L	10 L	315	*	510 000 009	315	•	510 101 007
L	12 L	315	*	510 000 010	315	•	510 101 008
L	15 L	315	•*	510 000 011	315	•	510 101 009
L	18 L	315	*	510 000 012	315	•	510 101 010
L	22 L	250	*	510 000 013	160	•	510 101 011
L	28 L	250	*	510 000 014	160	•	510 101 012
L	35 L	160	•*	510 000 015	160	•	510 101 013
L	42 L	160	•*	510 000 016	160	•	510 101 014
S	6 S	630	•*	510 000 017	630	•	510 101 015
S	8 S	630	•*	510 000 018	630	•	510 101 016
S	10 S	630	*	510 000 019	630	•	510 101 017
S	12 S	630	*	510 000 020	630	•	510 101 018
S	14 S	630	*	510 000 021	400	•	510 101 019
S	16 S	420	*	510 000 022	400	•	510 101 020
S	20 S	420	*	510 000 023	315	•	510 101 021
S	25 S	420	*	510 000 024	315	•	510 101 022
S	30 S	400	*	510 000 025	315	•	510 101 023
S	38 S	315	•*	510 000 026	315	•	510 101 024



DIN 98 R



SERIE LL / L

Serie Series	Ø Esterno O.D.	Ø Esterno O.D.	Pr. Esercizio Max WP	Intermedio Diritto Ridotto Reduced Straight Coupling
	mm	mm	bar	Codice / Part. nr.
LL	6 LL	4 LL	100	● 598 002 001
LL	8 LL	4 LL	100	● 598 002 002
LL	8 LL	6 LL	100	● 598 002 003
L	8 L	6 L	500	598 002 004
L	10 L	6 L	500	598 002 005
L	10 L	8 L	500	598 002 006
L	12 L	6 L	500	598 002 007
L	12 L	8 L	400	598 002 008
L	12 L	10 L	400	598 002 009
L	15 L	10 L	400	598 002 010
L	15 L	12 L	400	598 002 011
L	18 L	10 L	400	● 598 002 012
L	18 L	12 L	400	● 598 002 013
L	18 L	15 L	400	● 598 002 014
L	22 L	12 L	250	● 598 002 015
L	22 L	15 L	250	● 598 002 016
L	22 L	18 L	250	● 598 002 017
L	28 L	18 L	250	● 598 002 018
L	28 L	22 L	250	● 598 002 019
L	35 L	22 L	250	● 598 002 020
L	35 L	28 L	250	● 598 002 021

● Fornibile in 7 gg lavorativi / Available in 7 working days



DIN 98 R



SERIE S

Serie Series	Ø Esterno O.D.	Ø Esterno O.D.	Pr. Esercizio Max WP	Intermedio Diritto Ridotto Reduced Straight Coupling
	mm	mm	bar	Codice / Part. nr.
S	8 S	6 S	630	● 598 002 022
S	10 S	6 S	630	● 598 002 023
S	10 S	8 S	630	● 598 002 024
S	12 S	6 S	630	● 598 002 025
S	12 S	8 S	630	● 598 002 026
S	12 S	10 S	630	● 598 002 027
S	14 S	10 S	630	● 598 002 028
S	14 S	12 S	630	● 598 002 029
S	16 S	12 S	420	● 598 002 030
S	16 S	14 S	420	● 598 002 031
S	20 S	10 S	420	● 598 002 032
S	20 S	12 S	420	● 598 002 033
S	20 S	14 S	420	● 598 002 034
S	20 S	16 S	420	● 598 002 035
S	25 S	16 S	420	● 598 002 036
S	25 S	20 S	420	● 598 002 037
S	30 S	20 S	420	● 598 002 038
S	30 S	25 S	420	● 598 002 039
S	38 S	25 S	315	● 598 002 040
S	38 S	30 S	315	● 598 002 041

● Fornibile in 7 gg lavorativi / Available in 7 working days

* Fornibile anche in Acciaio Inox / Also Stainless Steel available



DIN 100 R



SERIE L

Serie Series	Ø Esterno Tubo G1 G1 Tube O.D.	Ø Esterno Tubo G2 G2 Tube O.D.	Ø Esterno Tubo G3 G3 Tube O.D.	Pr. Esercizio Max WP		Intermedio Diritto Ridotto Reduced Straight Coupling
	mm	mm	mm			
L	6 L	8 L	6 L	315	●	510 001 001
L	6 L	10 L	6 L	315	●	510 001 003
L	8 L	6 L	8 L	315	●	510 001 002
L	8 L	10 L	8 L	315	●	510 001 004
L	8 L	12 L	8 L	315	●	510 001 008
L	10 L	6 L	10 L	315	●	510 001 005
L	10 L	8 L	10 L	315	●	510 001 006
L	10 L	10 L	6 L	315	●	510 001 007
L	10 L	15 L	10 L	315	●	510 001 015
L	12 L	6 L	12 L	315	●	510 001 009
L	12 L	8 L	8 L	315	●	510 001 010
L	12 L	8 L	12 L	315	●	510 001 011
L	12 L	10 L	10 L	315	●	510 001 012
L	12 L	10 L	12 L	315	●	510 001 013
L	12 L	12 L	10 L	315	●	510 001 014
L	12 L	15 L	12 L	315	●	510 001 016
L	12 L	18 L	12 L	315	●	510 001 022
L	15 L	6 L	15 L	315	●	510 001 017
L	15 L	10 L	15 L	315	●	510 001 018
L	15 L	12 L	12 L	315	●	510 001 019
L	15 L	12 L	15 L	315	●	510 001 020
L	15 L	15 L	12 L	315	●	510 001 021
L	18 L	10 L	10 L	315	●	510 001 023
L	18 L	10 L	18 L	315	●	510 001 024
L	18 L	12 L	18 L	315	●	510 001 025
L	18 L	15 L	18 L	315	●	510 001 026
L	18 L	18 L	10 L	315	●	510 001 027
L	22 L	10 L	22 L	160	●	510 001 028
L	22 L	12 L	22 L	160	●	510 001 029
L	22 L	15 L	15 L	160	●	510 001 030
L	22 L	15 L	22 L	160	●	510 001 031
L	22 L	18 L	18 L	160	●	510 001 032
L	22 L	18 L	22 L	160	●	510 001 033

CONTINUA NELLA PAGINA SUCCESSIVA / FOLLOW TO NEXT PAGE



DIN 100 R



SERIE L/S

Serie Series	Ø Esterno Tubo G1 G1 Tube O.D.	Ø Esterno Tubo G2 G2 Tube O.D.	Ø Esterno Tubo G3 G3 Tube O.D.	Pr. Esercizio Max WP		Intermedio Diritto Ridotto Reduced Straight Coupling
	mm	mm	mm			
L	22 L	22 L	18 L	160	●	510 001 034
L	28 L	10 L	28 L	160	●	510 001 035
L	28 L	12 L	28 L	160	●	510 001 036
L	28 L	15 L	28 L	160	●	510 001 037
L	28 L	18 L	28 L	160	●	510 001 038
L	28 L	22 L	22 L	160	●	510 001 039
L	28 L	22 L	28 L	160	●	510 001 040
S	10 S	6 S	10 S	630	●	510 001 041
S	12 S	8 S	8 S	630	●	510 001 042
S	12 S	8 S	12 S	630	●	510 001 043
S	12 S	10 S	12 S	630	●	510 001 044
S	12 S	16 S	12 S	400	●	510 001 045
S	16 S	6 S	16 S	400	●	510 001 046
S	16 S	8 S	16 S	400	●	510 001 047
S	16 S	10 S	16 S	400	●	510 001 048
S	16 S	12 S	16 S	400	●	510 001 049
S	16 S	20 S	16 S	400	●	510 001 050
S	20 S	10 S	20 S	400	●	510 001 051
S	20 S	12 S	20 S	400	●	510 001 052
S	20 S	15 S	20 S	400	●	510 001 053
S	20 S	25 S	20 S	400	●	510 001 054
S	25 S	16 S	25 S	400	●	510 001 055
S	25 S	20 S	25 S	400	●	510 001 056
S	25 S	30 S	25 S	400	●	510 001 057

RACCORDI AD ANELLO DIN 2353 DIN 2353 CUTTING RING FITTINGS

RACCORDI PASSAPARETE



Serie Series	Ø Esterno O.D.	Pr. Esercizio Max WP	Attraversamento Diritto Bulkhead Connection		Attraversamento a Gomito Bulkhead Elbow		
			Codice / Part. nr.	Pr. Esercizio Max WP	Codice / Part. nr.		
	mm	bar		bar			
L	6 L	500	●	510 200 001	315	●	511 801 001
L	8 L	500		510 200 002	315		511 801 002
L	10 L	500		510 200 003	315		511 801 003
L	12 L	400		510 200 004	315		511 801 004
L	15 L	400		510 200 005	315		511 801 005
L	18 L	400		510 200 006	315	●	511 801 006
L	22 L	250		510 200 007	160	●	511 801 007
L	28 L	250	●	510 200 008	160	●	511 801 008
L	35 L	250	●	510 200 009	160	●	511 801 009
L	42 L	250	●	510 200 010	160	●	511 801 010
S	6 S	630	●	510 200 011	630	●	511 801 011
S	8 S	630	●	510 200 012	630	●	511 801 012
S	10 S	630		510 200 013	630	●	511 801 013
S	12 S	630	●	510 200 014	630	●	511 801 014
S	14 S	630	●	510 200 015	630	●	511 801 015
S	16 S	420		510 200 016	400	●	511 801 016
S	20 S	420	●	510 200 017	400	●	511 801 017
S	25 S	420		510 200 018	400	●	511 801 018
S	30 S	420	●	510 200 019	400	●	511 801 019
S	38 S	315	●	510 200 020	315	●	511 801 020

● Fornibile in 7 gg lavorativi / Available in 7 working days

RACCORDI AD ANELLO DIN 2353 DIN 2353 CUTTING RING FITTINGS

RACCORDI PASSAPARETE DIN/GAS BSPP



FILETTO DIN 2353 GAS CILINDRICO



Serie Series	Ø Esterno Tubo - Filetto Tube OD - Thread	Filetto Thread	Pr. Esercizio Max WP	Attraversamento Diritto M.DIN / M.Gas M.DIN / M.BSPP Bulkhead Connection	
				Codice / Part. nr.	Pr. Esercizio Max WP
	mm	Inch	bar		bar
L	8 L - M 14x1,5	G 1/4"-19	315	●	510 210 804
L	8 L - M 14x1,5	G 3/8"-19	315	●	510 210 806
L	10 L - M 16x1,5	G 1/4"-19	315	●	510 211 004
L	10 L - M 16x1,5	G 1/2"-14	315	●	510 211 008
L	12 L - M 18x1,5	G 3/8"-19	315	●	510 211 206
L	12 L - M 18x1,5	G 1/2"-14	315		510 211 208
L	15 L - M 22x1,5	G 1/2"-14	315		510 211 508
L	18 L - M 26x1,5	G 1/2"-14	315	●	510 211 808
L	18 L - M 26x1,5	G 3/4"-14	315	●	510 211 812
L	22 L - M 30x2	G 3/4"-14	160	●	510 212 212
S	12 S - M 20x1,5	G 1/2"-14	630	●	510 221 208
S	16 S - M 24x1,5	G 1/2"-14	400	●	510 221 608
S	20 S - M 30x2	G 3/4"-14	400	●	510 222 012
S	25 S - M 36x2	G 3/4"-14	400	●	510 222 512
S	25 S - M 36x2	G 1"-11	400	●	510 222 516

RACCORDI PER MANOMETRO

FILETTO GAS CILINDRICO



Serie Series	Ø Esterno Tubo Tube OD	Filetto Thread	Pr. Esercizio Max WP	Attacco per Manometro Gauge Coupling	
				Codice / Part. nr.	Pr. Esercizio Max WP
	mm	Inch	bar		bar
LL	4 LL	G 1/4"-19	100	●	510 300 001
L	6 L	G 1/4"-19	315	●	510 300 002
L	8 L	G 1/4"-19	315	●	510 300 003
L	10 L	G 1/4"-19	315	●	510 300 004
L	12 L	G 1/4"-19	315	●	510 300 005
S	6 S	G 1/2"-14	630	●	510 300 006
S	8 S	G 1/2"-14	630	●	510 300 007
S	10 S	G 1/2"-14	630	●	510 300 008
S	12 S	G 1/2"-14	630	●	510 300 009

● Fornibile in 7 gg lavorativi / Available in 7 working days



DIN 111 R



DIN 111GG R



**FILETTO GAS
CILINDRICO**

Serie Series	Ø Esterno O.D.	Filetto Thread	Pr. Esercizio Max WP	Gomito orientabile filetto Gas cilindrico Rotary Elbow BSP		Gomito orientabile filetto Gas cilindrico con anello in gomma Rotary Elbow BSP with rubber ring	
				Codice / Part. nr.	Pr. Esercizio Max WP	Codice / Part. nr.	
	mm	Inch	bar		bar		
LL	4 LL	G 1/8"-28	100	●	511 101 001		
LL	5 LL	G 1/8"-28	100	●	511 101 002		
LL	6 LL	G 1/8"-28	100	●	511 101 003		
LL	8 LL	G 1/8"-28	100	●	511 101 004		
L	6 L	G 1/8"-28	315	●	511 101 005	315 ● 511 103 001	
L	8 L	G 1/4"-19	315	●	511 101 006	315 ● 511 103 002	
L	10 L	G 1/4"-19	315	●	511 101 007	315 ● 511 103 003	
L	12 L	G 3/8"-19	315	●	511 101 008	315 ● 511 103 004	
L	15 L	G 1/2"-14	315	●	511 101 009	315 ● 511 103 005	
L	18 L	G 1/2"-14	315	●	511 101 010	315 ● 511 103 006	
L	22 L	G 3/4"-14	160	●	511 101 011	160 ● 511 103 007	
L	28 L	G 1"-11	160	●	511 101 012	160 ● 511 103 008	
L	35 L	G 1.1/4"-11	160	●	511 101 013	160 ● 511 103 009	
L	42 L	G 1.1/2"-11	160	●	511 101 014	160 ● 511 103 010	
S	6 S	G 1/4"-19	400	●	511 101 015	400 ● 511 103 011	
S	8 S	G 1/4"-19	400	●	511 101 016	400 ● 511 103 012	
S	10 S	G 3/8"-19	400	●	511 101 017	400 ● 511 103 013	
S	12 S	G 3/8"-19	400	●	511 101 018	400 ● 511 103 014	
S	14 S	G 1/2"-14	400	●	511 101 019	400 ● 511 103 015	
S	16 S	G 1/2"-14	400	●	511 101 020	400 ● 511 103 016	
S	20 S	G 3/4"-14	400	●	511 101 021	400 ● 511 103 017	
S	25 S	G 1"-11	250	●	511 101 022	250 ● 511 103 018	
S	30 S	G 1.1/4"-11	250	●	511 101 023	250 ● 511 103 019	
S	38 S	G 1.1/2"-11	250	●	511 101 024	250 ● 511 103 020	

● Fornibile in 7 gg lavorativi / Available in 7 working days



DIN 136 R



DIN 136GG R



**FILETTO GAS
CILINDRICO**

Serie Series	Ø Esterno O.D.	Filetto Thread	Pr. Esercizio Max WP	TEE orientabile filetto Gas cilindrico Rotary TEE BSP		TEE orientabile filetto Gas cilindrico con anello in gomma Rotary TEE BSP with rubber ring	
				Codice / Part. nr.	Pr. Esercizio Max WP	Codice / Part. nr.	
	mm	Inch	bar		bar		
LL	4 LL	G 1/8"-28	100	●	513 601 001		
LL	5 LL	G 1/8"-28	100	●	513 601 002		
LL	6 LL	G 1/8"-28	100	●	513 601 003		
LL	8 LL	G 1/8"-28	100	●	513 601 004		
L	6 L	G 1/8"-28	315	●	513 601 005	315 ● 513 603 001	
L	8 L	G 1/4"-19	315	●	513 601 006	315 ● 513 603 002	
L	10 L	G 1/4"-19	315	●	513 601 007	315 ● 513 603 003	
L	12 L	G 3/8"-19	315	●	513 601 008	315 ● 513 603 004	
L	15 L	G 1/2"-14	315	●	513 601 009	315 ● 513 603 005	
L	18 L	G 1/2"-14	315	●	513 601 010	315 ● 513 603 006	
L	22 L	G 3/4"-14	160	●	513 601 011	160 ● 513 603 007	
L	28 L	G 1"-11	160	●	513 601 012	160 ● 513 603 008	
L	35 L	G 1.1/4"-11	160	●	513 601 013	160 ● 513 603 009	
L	42 L	G 1.1/2"-11	160	●	513 601 014	160 ● 513 603 010	
S	6 S	G 1/4"-19	400	●	513 601 015	400 ● 513 603 011	
S	8 S	G 1/4"-19	400	●	513 601 016	400 ● 513 603 012	
S	10 S	G 3/8"-19	400	●	513 601 017	400 ● 513 603 013	
S	12 S	G 3/8"-19	400	●	513 601 018	400 ● 513 603 014	
S	14 S	G 1/2"-14	400	●	513 601 019	400 ● 513 603 015	
S	16 S	G 1/2"-14	400	●	513 601 020	400 ● 513 603 016	
S	20 S	G 3/4"-14	400	●	513 601 021	400 ● 513 603 017	
S	25 S	G 1"-11	250	●	513 601 022	250 ● 513 603 018	
S	30 S	G 1.1/4"-11	250	●	513 601 023	250 ● 513 603 019	
S	38 S	G 1.1/2"-11	250	●	513 601 024	250 ● 513 603 020	

● Fornibile in 7 gg lavorativi / Available in 7 working days



DIN 111 M



DIN 111GG M



**FILETTO METRICO
CILINDRICO**

Serie Series	Ø Esterno O.D.	Filetto Thread	Pr. Esercizio Max WP		Gomito orientabile filetto Metrico cilindrico Rotary Elbow Metric	Pr. Esercizio Max WP	Gomito orientabile filetto Metrico cilindrico con anello in gomma Rotary Elbow Metric with rubber ring
	mm	Inch	bar		Codice / Part. nr.	bar	Codice / Part. nr.
LL	4 LL	M 8x1	100	●	511 100 001		
LL	5 LL	M 8x1	100	●	511 100 002		
LL	6 LL	M 10x1	100	●	511 100 003		
LL	8 LL	M 10x1	100	●	511 100 004		
L	6 L	M 10x1	315	●	511 100 005	315	● 511 102 001
L	8 L	M 12x1,5	315	●	511 100 006	315	● 511 102 002
L	10 L	M 14x1,5	315	●	511 100 007	315	● 511 102 003
L	12 L	M 16x1,5	315	●	511 100 008	315	● 511 102 004
L	15 L	M 18x1,5	315	●	511 100 009	315	● 511 102 005
L	18 L	M 22x1,5	315	●	511 100 010	315	● 511 102 006
L	22 L	M 26x1,5	160	●	511 100 011	160	● 511 102 007
L	28 L	M 33x2	160	●	511 100 012	160	● 511 102 008
L	35 L	M 42x2	160	●	511 100 013	160	● 511 102 009
L	42 L	M 48x2	160	●	511 100 014	160	● 511 102 010
S	6 S	M 12x1,5	400	●	511 100 015	400	● 511 102 011
S	8 S	M 14x1,5	400	●	511 100 016	400	● 511 102 012
S	10 S	M 16x1,5	400	●	511 100 017	400	● 511 102 013
S	12 S	M 18x1,5	400	●	511 100 018	400	● 511 102 014
S	14 S	M 20x1,5	400	●	511 100 019	400	● 511 102 015
S	16 S	M 22x1,5	400	●	511 100 020	400	● 511 102 016
S	20 S	M 27x2	400	●	511 100 021	400	● 511 102 017
S	25 S	M 33x2	250	●	511 100 022	250	● 511 102 018
S	30 S	M 42x2	250	●	511 100 023	250	● 511 102 019
S	38 S	M 48x2	250	●	511 100 024	250	● 511 102 020

● Fornibile in 7 gg lavorativi / Available in 7 working days



DIN 136 M



DIN 136GG M



**FILETTO METRICO
CILINDRICO**

Serie Series	Ø Esterno O.D.	Filetto Thread	Pr. Esercizio Max WP		TEE orientabile filetto Metrico cilindrico Rotary TEE Met	Pr. Esercizio Max WP	TEE orientabile filetto Metrico cilindrico con anello in gomma Rotary TEE Metric with rubber ring
	mm	Inch	bar		Codice / Part. nr.	bar	Codice / Part. nr.
LL	4 LL	M 8x1	100	●	513 600 001		
LL	5 LL	M 8x1	100	●	513 600 002		
LL	6 LL	M 10x1	100	●	513 600 003		
LL	8 LL	M 10x1	100	●	513 600 004		
L	6 L	M 10x1	315	●	513 600 005	315	● 513 602 001
L	8 L	M 12x1,5	315	●	513 600 006	315	● 513 602 002
L	10 L	M 14x1,5	315	●	513 600 007	315	● 513 602 003
L	12 L	M 16x1,5	315	●	513 600 008	315	● 513 602 004
L	15 L	M 18x1,5	315	●	513 600 009	315	● 513 602 005
L	18 L	M 22x1,5	315	●	513 600 010	315	● 513 602 006
L	22 L	M 26x1,5	160	●	513 600 011	160	● 513 602 007
L	28 L	M 33x2	160	●	513 600 012	160	● 513 602 008
L	35 L	M 42x2	160	●	513 600 013	160	● 513 602 009
L	42 L	M 48x2	160	●	513 600 014	160	● 513 602 010
S	6 S	M 12x1,5	400	●	513 600 015	400	● 513 602 011
S	8 S	M 14x1,5	400	●	513 600 016	400	● 513 602 012
S	10 S	M 16x1,5	400	●	513 600 017	400	● 513 602 013
S	12 S	M 18x1,5	400	●	513 600 018	400	● 513 602 014
S	14 S	M 20x1,5	400	●	513 600 019	400	● 513 602 015
S	16 S	M 22x1,5	400	●	513 600 020	400	● 513 602 016
S	20 S	M 27x2	400	●	513 600 021	400	● 513 602 017
S	25 S	M 33x2	250	●	513 600 022	250	● 513 602 018
S	30 S	M 42x2	250	●	513 600 023	250	● 513 602 019
S	38 S	M 48x2	250	●	513 600 023	250	● 513 602 020

● Fornibile in 7 gg lavorativi / Available in 7 working days

RACCORDI AD ANELLO DIN 2353 DIN 2353 CUTTING RING FITTINGS

RACCORDI DI ESTREMITÀ FEMMINA BSP

HSR[®]

DIN 147 R



FILETTO GAS CILINDRICO

Serie Series	Ø Esterno Tubo - Filetto Tube OD - Thread	Filetto Thread	Pr. Esercizio Max WP	Dritto di Estremità Femmina Gas cilindrico Straight Female Stud Couplings BSP	Codice / Part. nr.
	mm	mm	bar		
L	6 L	G 1/8"-28	315	●	514 701 001
L	8 L	G 1/4"-19	315	●	514 701 002
L	8 L	G 3/8"-19	315	●	514 701 021
L	8 L	G 1/2"-14	315	●	514 701 022
L	10 L	G 1/4"-19	315	●	514 701 003
L	10 L	G 3/8"-19	315	●	514 701 023
L	10 L	G 1/2"-14	315	●	514 701 024
L	12 L	G 3/8"-19	315	●	514 701 004
L	12 L	G 1/2"-14	315	●	514 701 025
L	15 L	G 1/2"-14	315	●	514 701 005
L	18 L	G 1/2"-14	315	●	514 701 006
L	22 L	G 3/4"-14	160	●	514 701 007
L	28 L	G 1"-11	160	●	514 701 008
L	35 L	G 1.1/4"-11	160	●	514 701 009
L	42 L	G 1.1/2"-11	160	●	514 701 010
S	6 S	G 1/4"-19	400	●	514 701 011
S	8 S	G 1/4"-19	400	●	514 701 012
S	10 S	G 3/8"-19	400	●	514 701 013
S	12 S	G 3/8"-19	400	●	514 701 014
S	14 S	G 1/2"-14	400	●	514 701 015
S	16 S	G 1/2"-14	400	●	514 701 016
S	20 S	G 3/4"-14	315	●	514 701 017
S	25 S	G 1"-11	315	●	514 701 018
S	30 S	G 1.1/4"-11	315	●	514 701 019
S	38 S	G 1.1/2"-11	315	●	514 701 020

● Fornibile in 7 gg lavorativi / Available in 7 working days

RACCORDI AD ANELLO DIN 2353 DIN 2353 CUTTING RING FITTINGS

RACCORDI PASSAPARETE DIN/GAS BSPP

HSR[®]

DIN 147 M



FILETTO METRICO CILINDRICO

Serie Series	Ø Esterno Tubo - Filetto Tube OD - Thread	Filetto Thread	Pr. Esercizio Max WP	Dritto di Estremità Femmina Metrico Straight Female Stud Couplings Metric	Codice / Part. nr.
	mm	mm	bar		
L	6 L	M 10x1	315	●	514 700 001
L	8 L	M 12x1,5	315	●	514 700 002
L	10 L	M 14x1,5	315	●	514 700 003
L	12 L	M 16x1,5	315	●	514 700 004
L	15 L	M 18x1,5	315	●	514 700 005
L	18 L	M 22x1,5	315	●	514 700 006
L	22 L	M 26x1,5	160	●	514 700 007
L	28 L	M 33x2	160	●	514 700 008
L	35 L	M 42x2	160	●	514 700 009
L	42 L	M 48x2	160	●	514 700 010
S	6 S	M 12x1,5	400	●	514 700 011
S	8 S	M 14x1,5	400	●	514 700 012
S	10 S	M 16x1,5	400	●	514 700 013
S	12 S	M 18x1,5	400	●	514 700 014
S	14 S	M 20x1,5	400	●	514 700 015
S	16 S	M 22x1,5	400	●	514 700 016
S	20 S	M 27x2	315	●	514 700 017
S	25 S	M 33x2	315	●	514 700 018
S	30 S	M 42x2	315	●	514 700 019
S	38 S	M 48x2	315	●	514 700 020

● Fornibile in 7 gg lavorativi / Available in 7 working days



DIN 126GG R



DIN 126AGG R



**FILETTO GAS
CILINDRICO**

Serie Series	Ø Esterno Tubo Filetto Tube OD - Thread	Filetto Thread	Pr. Esercizio Max WP	Adattatore di Estremità Liscio Gas cilindrico Straight Stud Standpipe Adapters BSP		Adattatore di Estremità Serrato Gas cilindrico Adjustable Straight Stud Standpipe Adapters BSP		
				Codice / Part. nr.	Pr. Esercizio Max WP	Codice / Part. nr.	Pr. Esercizio Max WP	
	mm	Inch	bar		bar		bar	
L	6 L - M 12x1,5	G 1/8"-28	315	●	512 601 001	500	*	512 603 001
L	8 L - M 14x1,5	G 1/4"-19	315	●	512 601 002	500	*	512 603 002
L	10 L - M 16x1,5	G 1/4"-19	315	●	512 601 003	500	*	512 603 003
L	12 L - M 18x1,5	G 3/8"-19	315	●	512 601 004	400	*	512 603 004
L	15 L - M 22x1,5	G 1/2"-14	315	●	512 601 005	400	*	512 603 005
L	18 L - M 26x1,5	G 1/2"-14	315	●	512 601 006	400	*	512 603 006
L	22 L - M 30x2	G 3/4"-14	160	●	512 601 007	250	*	512 603 007
L	28 L - M 36x2	G 1"-11	160	●	512 601 008	250	*	512 603 008
L	35 L - M 45x2	G 1.1/4"-11	160	●	512 601 009	250	●*	512 603 009
L	42 L - M 52x2	G 1.1/2"-11	160	●	512 601 010	250	●*	512 603 010
S	6 S - M 14x1,5	G 1/4"-19	630	●	512 601 011	630	*	512 603 011
S	8 S - M 16x1,5	G 1/4"-19	630	●	512 601 012	630	*	512 603 012
S	10 S - M 18x1,5	G 3/8"-19	630	●	512 601 013	630	*	512 603 013
S	12 S - M 20x1,5	G 3/8"-19	630	●	512 601 014	630	*	512 603 014
S	14 S - M 22x1,5	G 1/2"-14	630	●	512 601 015	630	*	512 603 015
S	16 S - M 24x1,5	G 1/2"-14	400	●	512 601 016	420	*	512 603 016
S	20 S - M 30x2	G 3/4"-14	400	●	512 601 017	420	*	512 603 017
S	25 S - M 36x2	G 1"-11	400	●	512 601 018	420	*	512 603 018
S	30 S - M 42x2	G 1.1/4"-11	400	●	512 601 019	420	●*	512 603 019
S	38 S - M 52x2	G 1.1/2"-11	315	●	512 601 020	315	●*	512 603 020



DIN 126GG M



DIN 126AGG M



**FILETTO METRICO
CILINDRICO**

Serie Series	Ø Esterno Tubo Filetto Tube OD - Thread	Filetto Thread	Pr. Esercizio Max WP	Adattatore di Estremità Liscio Metrico cilindrico Straight Stud Standpipe Adapters Metric		Adattatore di Estremità Serrato Metrico cilindrico Adjustable Straight Stud Standpipe Adapters Metric		
				Codice / Part. nr.	Pr. Esercizio Max WP	Codice / Part. nr.	Pr. Esercizio Max WP	
	mm	mm	bar		bar		bar	
L	6 L - M 12x1,5	M 10x1	315	●	512 602 001	500	*	512 604 001
L	8 L - M 14x1,5	M 12x1,5	315	●	512 602 002	500	*	512 604 002
L	10 L - M 16x1,5	M 14x1,5	315	●	512 602 003	500	*	512 604 003
L	12 L - M 18x1,5	M 16x1,5	315	●	512 602 004	400	*	512 604 004
L	15 L - M 22x1,5	M 18x1,5	315	●	512 602 005	400	*	512 604 005
L	18 L - M 26x1,5	M 22x1,5	315	●	512 602 006	400	*	512 604 006
L	22 L - M 30x2	M 26x1,5	160	●	512 602 007	250	*	512 604 007
L	28 L - M 36x2	M 33x2	160	●	512 602 008	250	*	512 604 008
L	35 L - M 45x2	M 42x2	160	●	512 602 009	250	●*	512 604 009
L	42 L - M 52x2	M 48x2	160	●	512 602 010	250	●*	512 604 010
S	6 S - M 14x1,5	M 12x1,5	630	●	512 602 011	630	*	512 604 011
S	8 S - M 16x1,5	M 14x1,5	630	●	512 602 012	630	*	512 604 012
S	10 S - M 18x1,5	M 16x1,5	630	●	512 602 013	630	*	512 604 013
S	12 S - M 20x1,5	M 18x1,5	630	●	512 602 014	630	*	512 604 014
S	14 S - M 22x1,5	M 20x1,5	630	●	512 602 015	630	*	512 604 015
S	16 S - M 24x1,5	M 22x1,5	400	●	512 602 016	420	*	512 604 016
S	20 S - M 30x2	M 27x2	400	●	512 602 017	420	*	512 604 017
S	25 S - M 36x2	M 33x2	400	●	512 602 018	420	*	512 604 018
S	30 S - M 42x2	M 42x2	400	●	512 602 019	420	●*	512 604 019
S	38 S - M 52x2	M 48x2	315	●	512 602 020	315	●*	512 604 020



DIN 119



**FILETTO GAS
CILINDRICO**

Serie Series	Ø Esterno Tubo - Filetto Tube OD - Thread	Filetto Thread	Pr. Esercizio Max WP	Gomito orientabile serrato Preassembled Adjustable Elbow	Codice / Part. nr.
L	6 L - M 12x1,5	M 12x1,5	315	●	511 901 001
L	8 L - M 14x1,5	M 14x1,5	315	●	511 901 002
L	10 L - M 16x1,5	M 16x1,5	315	●	511 901 003
L	12 L - M 18x1,5	M 18x1,5	315	●	511 901 004
L	15 L - M 22x1,5	M 22x1,5	315	●	511 901 005
L	18 L - M 26x1,5	M 26x1,5	315	●	511 901 006
L	22 L - M 30x2	M 30x2	160	●	511 901 007
L	28 L - M 36x2	M 36x2	160	●	511 901 008
L	35 L - M 45x2	M 45x2	160	●	511 901 009
L	42 L - M 52x2	M 52x2	160	●	511 901 010
S	6 S - M 14x1,5	M 14x1,5	630	●	511 901 011
S	8 S - M 16x1,5	M 16x1,5	630	●	511 901 012
S	10 S - M 18x1,5	M 18x1,5	630	●	511 901 013
S	12 S - M 20x1,5	M 20x1,5	630	●	511 901 014
S	14 S - M 22x1,5	M 22x1,5	400	●	511 901 015
S	16 S - M 24x1,5	M 24x1,5	400	●	511 901 016
S	20 S - M 30x2	M 30x2	400	●	511 901 017
S	25 S - M 36x2	M 36x2	400	●	511 901 018
S	30 S - M 42x2	M 42x2	400	●	511 901 019
S	38 S - M 52x2	M 52x2	315	●	511 901 020



DIN 120



DIN 121



**FILETTO METRICO
CILINDRICO**

Serie Series	Ø Esterno Tubo Filetto Tube OD - Thread	Filetto Thread	Pr. Esercizio Max WP	TEE orientabile centrale serrata Preassembled Adjustable central TEE		TEE orientabile laterale serrata Preassembled Adjustable lateral TEE		
				Codice / Part. nr.	bar	bar	Codice / Part. nr.	
L	6 L - M 12x1,5	M 12x1,5	315	●	512 001 001	315	●	512 101 001
L	8 L - M 14x1,5	M 14x1,5	315	●	512 001 002	315	●	512 101 002
L	10 L - M 16x1,5	M 16x1,5	315	●	512 001 003	315	●	512 101 003
L	12 L - M 18x1,5	M 18x1,5	315	●	512 001 004	315	●	512 101 004
L	15 L - M 22x1,5	M 22x1,5	315	●	512 001 005	315	●	512 101 005
L	18 L - M 26x1,5	M 26x1,5	315	●	512 001 006	315	●	512 101 006
L	22 L - M 30x2	M 30x2	160	●	512 001 007	160	●	512 101 007
L	28 L - M 36x2	M 36x2	160	●	512 001 008	160	●	512 101 008
L	35 L - M 45x2	M 45x2	160	●	512 001 009	160	●	512 101 009
L	42 L - M 52x2	M 52x2	160	●	512 001 010	160	●	512 101 010
S	6 S - M 14x1,5	M 14x1,5	630	●	512 001 011	630	●	512 101 011
S	8 S - M 16x1,5	M 16x1,5	630	●	512 001 012	630	●	512 101 012
S	10 S - M 18x1,5	M 18x1,5	630	●	512 001 013	630	●	512 101 013
S	12 S - M 20x1,5	M 20x1,5	630	●	512 001 014	630	●	512 101 014
S	14 S - M 22x1,5	M 22x1,5	400	●	512 001 015	400	●	512 101 015
S	16 S - M 24x1,5	M 24x1,5	400	●	512 001 016	400	●	512 101 016
S	20 S - M 30x2	M 30x2	400	●	512 001 017	400	●	512 101 017
S	25 S - M 36x2	M 36x2	400	●	512 001 018	400	●	512 101 018
S	30 S - M 42x2	M 42x2	400	●	512 001 019	400	●	512 101 019
S	38 S - M 52x2	M 52x2	315	●	512 001 020	315	●	512 101 020



DIN 132A



SERIE LL / L

Serie Series	Ø Esterno Tubo - Filetto Tube OD - Thread	Filetto Thread	Pr. Esercizio Max WP	Gomito orientabile serrato Preassembled Adjustable Elbow	Codice / Part. nr.
	mm	mm			
LL	6 LL - M 10x1	4 LL	100	●	513 200 001
LL	8 LL - M 12x1	4 LL	100	●	513 200 002
LL	8 LL - M 12x1	6 LL	100	●	513 200 003
L	6 L - M 12x1,5	4 LL	315	●	513 200 004
L	8 L - M 14x1,5	4 LL	315	●	513 200 005
L	8 L - M 14x1,5	6 L	315	●	513 201 001
L	10 L - M 16x1,5	4 LL	315	●	513 200 006
L	10 L - M 16x1,5	6 L	315	●	513 201 002
L	10 L - M 16x1,5	8 L	315	●	513 201 003
L	12 L - M 18x1,5	4 LL	315	●	513 200 007
L	12 L - M 18x1,5	6 L	315	●	513 201 004
L	12 L - M 18x1,5	8 L	315	●	513 201 005
L	12 L - M 18x1,5	10 L	315	●	513 201 006
L	15 L - M 22x1,5	6 L	315	●	513 201 007
L	15 L - M 22x1,5	8 L	315	●	513 201 008
L	15 L - M 22x1,5	10 L	315	●	513 201 009
L	15 L - M 22x1,5	12 L	315	●	513 201 010
L	18 L - M 26x1,5	6 L	315	●	513 201 011
L	18 L - M 26x1,5	8 L	315	●	513 201 012
L	18 L - M 26x1,5	10 L	315	●	513 201 013
L	18 L - M 26x1,5	12 L	315	●	513 201 014
L	18 L - M 26x1,5	15 L	315	●	513 201 015
L	22 L - M 30x2	6 L	160	●	513 201 016
L	22 L - M 30x2	8 L	160	●	513 201 017
L	22 L - M 30x2	10 L	160	●	513 201 018
L	22 L - M 30x2	12 L	160	●	513 201 019
L	22 L - M 30x2	15 L	160	●	513 201 020
L	22 L - M 30x2	18 L	160	●	513 201 021
L	28 L - M 36x2	6 L	160	●	513 201 022
L	28 L - M 36x2	8 L	160	●	513 201 023
L	28 L - M 36x2	10 L	160	●	513 201 024
L	28 L - M 36x2	12 L	160	●	513 201 025
L	28 L - M 36x2	15 L	160	●	513 201 026

CONTINUA NELLA PAGINA SUCCESSIVA / FOLLOW TO NEXT PAGE



DIN 132A



SERIE L / S

Serie Series	Ø Esterno Tubo - Filetto Tube OD - Thread	Filetto Thread	Pr. Esercizio Max WP	Raccordo di Riduzione Serrato Standpipe Reducers Coupling	Codice / Part. nr.
	mm	mm			
L	28 L - M 36x2	18 L	160	●	513 201 027
L	28 L - M 36x2	22 L	160	●	513 201 028
L	35 L - M 45x2	6 L	160	●	513 201 029
L	35 L - M 45x2	8 L	160	●	513 201 030
L	35 L - M 45x2	10 L	160	●	513 201 031
L	35 L - M 45x2	12 L	160	●	513 201 032
L	35 L - M 45x2	15 L	160	●	513 201 033
L	35 L - M 45x2	18 L	160	●	513 201 034
L	35 L - M 45x2	22 L	160	●	513 201 035
L	35 L - M 45x2	28 L	160	●	513 201 036
L	42 L - M 52x2	6 L	160	●	513 201 037
L	42 L - M 52x2	8 L	160	●	513 201 038
L	42 L - M 52x2	10 L	160	●	513 201 039
L	42 L - M 52x2	12 L	160	●	513 201 040
L	42 L - M 52x2	15 L	160	●	513 201 041
L	42 L - M 52x2	18 L	160	●	513 201 042
L	42 L - M 52x2	22 L	160	●	513 201 043
L	42 L - M 52x2	28 L	160	●	513 201 044
L	42 L - M 52x2	35 L	160	●	513 201 045
S	8 S - M 16x1,5	6 S	630	●	513 202 001
S	10 S - M 18x1,5	6 S	630	●	513 202 002
S	10 S - M 18x1,5	8 S	630	●	513 202 003
S	12 S - M 20x1,5	6 S	630	●	513 202 004
S	12 S - M 20x1,5	8 S	630	●	513 202 005
S	12 S - M 20x1,5	10 S	630	●	513 202 006
S	14 S - M 22x1,5	6 S	630	●	513 202 007
S	14 S - M 22x1,5	8 S	630	●	513 202 008
S	14 S - M 22x1,5	10 S	630	●	513 202 009
S	14 S - M 22x1,5	12 S	630	●	513 202 010
S	16 S - M 24x1,5	6 S	630	●	513 202 011
S	16 S - M 24x1,5	8 S	630	●	513 202 012
S	16 S - M 24x1,5	10 S	630	●	513 202 013
S	16 S - M 24x1,5	12 S	630	●	513 202 014

CONTINUA NELLA PAGINA SUCCESSIVA / FOLLOW TO NEXT PAGE



DIN 132A



SERIE S

Serie Series	Ø Esterno Tubo - Filetto Tube OD - Thread	Filetto Thread	Pr. Esercizio Max WP		Gomito orientabile serrato Preassembled Adjustable Elbow
					Codice / Part. nr.
S	16 S - M 24x1,5	14 S	400	●	513 202 015
S	20 S - M 30x2	6 S	400	●	513 202 016
S	20 S - M 30x2	8 S	400	●	513 202 017
S	20 S - M 30x2	10 S	400	●	513 202 018
S	20 S - M 30x2	12 S	400	●	513 202 019
S	20 S - M 30x2	14 S	400	●	513 202 020
S	20 S - M 30x2	16 S	400	●	513 202 021
S	25 S - M 36x2	6 S	400	●	513 202 022
S	25 S - M 36x2	8 S	400	●	513 202 023
S	25 S - M 36x2	10 S	400	●	513 202 024
S	25 S - M 36x2	12 S	400	●	513 202 025
S	25 S - M 36x2	14 S	400	●	513 202 026
S	25 S - M 36x2	16 S	400	●	513 202 027
S	25 S - M 36x2	20 S	400	●	513 202 028
S	30 S - M 42x2	6 S	400	●	513 202 029
S	30 S - M 42x2	8 S	400	●	513 202 030
S	30 S - M 42x2	10 S	400	●	513 202 031
S	30 S - M 42x2	12 S	400	●	513 202 032
S	30 S - M 42x2	14 S	400	●	513 202 033
S	30 S - M 42x2	16 S	400	●	513 202 034
S	30 S - M 42x2	20 S	400	●	513 202 035
S	30 S - M 42x2	25 S	400	●	513 202 036
S	38 S - M 52x2	6 S	315	●	513 202 037
S	38 S - M 52x2	8 S	315	●	513 202 038
S	38 S - M 52x2	10 S	315	●	513 202 039
S	38 S - M 52x2	12 S	315	●	513 202 040
S	38 S - M 52x2	14 S	315	●	513 202 041
S	38 S - M 52x2	16 S	315	●	513 202 042
S	38 S - M 52x2	20 S	315	●	513 202 043
S	38 S - M 52x2	25 S	315	●	513 202 044
S	38 S - M 52x2	30 S	315	●	513 202 045

● Fornibile in 7 gg lavorativi / Available in 7 working days



DIN 514 R



**FILETTO GAS
CILINDRICO**

DIN 517 R



Serie Series	Ø Esterno O.D.	Filetto Thread	Pr. Esercizio Max WP		Gomito 90° orientabile con controdado Rotary 90° Elbow with bulkhead nut	Pr. Esercizio Max WP		Gomito 45° orientabile con controdado Rotary 45° Elbow with bulkhead nut
					Codice / Part. nr.			bar
LL	4 LL	G 1/8"-28	250	●	551 400 001			
LL	6 LL	G 1/8"-28	250	●	551 400 002			
L	6 L	G 1/8"-28	315	●	551 400 003	315	●	551 700 001
L	8 L	G 1/4"-19	315	●	551 400 004	315	●	551 700 002
L	10 L	G 1/4"-19	315	●	551 400 005	315	●	551 700 003
L	12 L	G 3/8"-19	250	●	551 400 006	250	●	551 700 004
L	15 L	G 1/2"-14	250	●	551 400 007	250	●	551 700 005
L	18 L	G 1/2"-14	250	●	551 400 008	250	●	551 700 006
L	22 L	G 3/4"-14	160	●	551 400 009	160	●	551 700 007
L	28 L	G 1"-11	160	●	551 400 010	160	●	551 700 008
L	35 L	G 1.1/4"-11	160	●	551 400 011	160	●	551 700 009
L	42 L	G 1.1/2"-11	160	●	551 400 012	160	●	551 700 010
S	6 S	G 1/4"-19	315	●	551 400 013	315	●	551 700 011
S	8 S	G 1/4"-19	315	●	551 400 014	315	●	551 700 012
S	10 S	G 3/8"-19	250	●	551 400 015	250	●	551 700 013
S	12 S	G 3/8"-19	250	●	551 400 016	250	●	551 700 014
S	14 S	G 1/2"-14	250	●	551 400 017	250	●	551 700 015
S	16 S	G 1/2"-14	250	●	551 400 018	250	●	551 700 016
S	20 S	G 3/4"-14	250	●	551 400 019	250	●	551 700 017
S	25 S	G 1"-11	250	●	551 400 020	250	●	551 700 018
S	30 S	G 1.1/4"-11	160	●	551 400 021	160	●	551 700 019
S	38 S	G 1.1/2"-11	160	●	551 400 022	160	●	551 700 020

● Fornibile in 7 gg lavorativi / Available in 7 working days



**FILETTO
GAS
CILINDRICO**

DIN 515 R



DIN 516 R



Serie Series	Ø Esterno Tubo Tube OD	Filetto Thread	Pr. Esercizio Max WP	TEE orientabile centrale con controdado Rotary central TEE with bulkhead nut		TEE orientabile laterale con controdado Rotary lateral TEE with bulkhead nut		
				Codice / Part. nr.	●	bar	Codice / Part. nr.	●
	mm	Inch	bar					
L	6 L	G 1/8"-28	315	●	551 500 001	315	●	551 600 001
L	8 L	G 1/4"-19	315	●	551 500 002	315	●	551 600 002
L	10 L	G 1/4"-19	315	●	551 500 003	315	●	551 600 003
L	12 L	G 3/8"-19	250	●	551 500 004	250	●	551 600 004
L	15 L	G 1/2"-14	250	●	551 500 005	250	●	551 600 005
L	18 L	G 1/2"-14	250	●	551 500 006	250	●	551 600 006
L	22 L	G 3/4"-14	160	●	551 500 007	160	●	551 600 007
L	28 L	G 1"-11	160	●	551 500 008	160	●	551 600 008
L	35 L	G 1.1/4"-11	160	●	551 500 009	160	●	551 600 009
L	42 L	G 1.1/2"-11	160	●	551 500 010	160	●	551 600 010
S	6 S	G 1/4"-19	315	●	551 500 011	315	●	551 600 011
S	8 S	G 1/4"-19	315	●	551 500 012	315	●	551 600 012
S	10 S	G 3/8"-19	250	●	551 500 013	250	●	551 600 013
S	12 S	G 3/8"-19	250	●	551 500 014	250	●	551 600 014
S	14 S	G 1/2"-14	250	●	551 500 015	250	●	551 600 015
S	16 S	G 1/2"-14	250	●	551 500 016	250	●	551 600 016
S	20 S	G 3/4"-14	250	●	551 500 017	250	●	551 600 017
S	25 S	G 1"-11	250	●	551 500 018	250	●	551 600 018
S	30 S	G 1.1/4"-11	160	●	551 500 019	160	●	551 600 019
S	38 S	G 1.1/2"-11	160	●	551 500 020	160	●	551 600 020



**FILETTO
GAS
CILINDRICO**

DIN 91



DIN 94 W



Serie Series	Ø Esterno Tubo Tube OD	Ø Esterno Estremità Saldabile Weldable End OD	Pr. Esercizio Max WP	Diritto Saldabile Weldable straight Couplings		Gomito Saldabile Weldable Elbow Couplings		
				Codice / Part. nr.	●	bar	Codice / Part. nr.	●
	mm	Inch	bar					
L	6 L	10	315	●	591 000 001	315	●	594 003 001
L	8 L	12	315	●	591 000 002	315	●	594 003 002
L	10 L	14	315	●	591 000 003	315	●	594 003 003
L	12 L	16	315	●	591 000 004	315	●	594 003 004
L	15 L	19	315	●	591 000 005	315	●	594 003 005
L	18 L	22	315	●	591 000 006	315	●	594 003 006
L	22 L	27	160	●	591 000 007	160	●	594 003 007
L	28 L	32	160	●	591 000 008	160	●	594 003 008
L	35 L	40	160	●	591 000 009	160	●	594 003 009
L	42 L	46	160	●	591 000 010	160	●	594 003 010
S	6 S	11	630	●	591 000 011	630	●	594 003 011
S	8 S	13	630	●	591 000 012	630	●	594 003 012
S	10 S	15	630	●	591 000 013	630	●	594 003 013
S	12 S	17	630	●	591 000 014	630	●	594 003 014
S	14 S	19	630	●	591 000 015	630	●	594 003 015
S	16 S	21	400	●	591 000 016	400	●	594 003 016
S	20 S	26	400	●	591 000 017	400	●	594 003 017
S	25 S	31	400	●	591 000 018	400	●	594 003 018
S	30 S	36	400	●	591 000 019	400	●	594 003 019
S	38 S	44	315	●	591 000 020	315	●	594 003 020

RACCORDI AD ANELLO DIN 2353 DIN 2353 CUTTING RING FITTINGS

RACCORDI A SALDARE

HSR®

DIN 117



Serie Series	Ø Esterno Tubo Tube OD	Ø Esterno Estremità Saldabile Welding End OD	Pr. Esercizio Max WP		Passaparatia Saldabile Weldable bulkhead Couplings
	mm	mm			bar
L	6 L	18	315	●	511 701 001
L	8 L	20	315	●	511 701 002
L	10 L	22	315	●	511 701 003
L	12 L	25	315	●	511 701 004
L	15 L	28	315	●	511 701 005
L	18 L	32	315	●	511 701 006
L	22 L	36	160	●	511 701 007
L	28 L	40	160	●	511 701 008
L	35 L	50	160	●	511 701 009
L	42 L	60	160	●	511 701 010
S	6 S	20	630	●	511 701 011
S	8 S	22	630	●	511 701 012
S	10 S	25	630	●	511 701 013
S	12 S	28	630	●	511 701 014
S	14 S	30	630	●	511 701 015
S	16 S	35	400	●	511 701 016
S	20 S	38	400	●	511 701 017
S	25 S	45	400	●	511 701 018
S	30 S	50	400	●	511 701 019
S	38 S	60	315	●	511 701 020

● Fornibile in 7 gg lavorativi / Available in 7 working days

RACCORDI AD ANELLO DIN 2353 DIN 2353 CUTTING RING FITTINGS

RACCORDI A SALDARE

HSR®

DIN 299 B



Serie Series	Ø Esterno Tubo Tube OD	Ø Esterno Estremità Saldabile Welding End OD	Pr. Esercizio Max WP		Codoli Saldabili Welding Nipples
	mm	mm			bar
L/S	10	1,5	413	●	529 900 000
L/S	10	2	459	●	529 900 001
L/S	12	1,5	304	●	529 900 002
L/S	12	2	392	●	529 900 003
L/S	12	2,5	475	●	529 900 004
L	15	2,5	315	●	529 900 005
L	18	2,5	315	●	529 900 006
L	22	2,5	160	●	529 900 007
L	28	2,5	160	●	529 900 008
L	35	3	160	●	529 900 009
L	42	3	160	●	529 900 010
S	14	3	485	●	529 900 011
S	16	2	304	●	529 900 012
S	16	2,5	370	●	529 900 013
S	20	3	400	●	529 900 014
S	20	2,5	304	●	529 900 015
S	20	3	358	●	529 900 016
S	20	4	400	●	529 900 017
S	25	3	293	●	529 900 018
S	25	4	377	●	529 900 019
S	30	5	400	●	529 900 020
S	30	3	248	●	529 900 021
S	30	4	322	●	529 900 022
S	30	5	391	●	529 900 023
S	38	6	315	●	529 900 024
S	38	3	160	●	529 900 025
S	38	5	315	●	529 900 026
S	38	6	315	●	529 900 027
S	38	7	315	●	529 900 028

● Fornibile in 7 gg lavorativi / Available in 7 working days

RACCORDI AD ANELLO DIN 2353 DIN 2353 CUTTING RING FITTINGS

TAPPI DI CHIUSURA FEMMINA



DIN 324



DIN 81

Serie Series	Ø Esterno Tubo Tube OD	O-ring	Pr. Esercizio Max WP	Tappo conico con O-Ring Blanking Plug with O-Ring	Pr. Esercizio Max WP	Dado di Serraggio Nut
				Codice / Part. nr.		Codice / Part. nr.
	mm	Inch	bar		bar	
L	6 L	4,0 x 1,5	630	532 400 001	500	581 000 007
L	8 L	6,0 x 1,5	630	532 400 002	500	581 000 008
L	10 L	7,5 x 1,5	630	532 400 003	500	581 000 009
L	12 L	9,0 x 1,5	630	532 400 004	400	581 000 010
L	15 L	12,0 x 2	400	532 400 005	400	581 000 011
L	18 L	15,0 x 2	400	532 400 006	400	581 000 012
L	22 L	20,0 x 2	250	532 400 007	250	581 000 013
L	28 L	26,0 x 2	250	532 400 008	250	581 000 014
L	35 L	32,0 x 2,5	250	532 400 009	250	581 000 015
L	42 L	38,0 x 2,5	250	532 400 010	250	581 000 016
S	6 S	4,0 x 1,5	630	532 400 001	630	581 000 017
S	8 S	6,0 x 1,5	630	532 400 002	630	581 000 018
S	10 S	7,5 x 1,5	630	532 400 003	630	581 000 019
S	12 S	9,0 x 1,5	630	532 400 004	630	581 000 020
S	14 S	10,0 x 2	630	532 400 011	630	581 000 021
S	16 S	12,0 x 2	420	532 400 012	420	581 000 022
S	20 S	16,3 x 2,4	420	532 400 013	420	581 000 023
S	25 S	20,3 x 2,4	420	532 400 014	420	581 000 024
S	30 S	25,3 x 2,4	420	532 400 015	420	581 000 025
S	38 S	33,3 x 2,4	315	532 400 016	315	581 000 026

RACCORDI AD ANELLO DIN 2353 DIN 2353 CUTTING RING FITTINGS

TAPPI DI CHIUSURA MASCHI



DIN 296 OM



DIN 296

Serie Series	Ø Esterno Tubo Tube OD	Filetto Thread	Pr. Esercizio Max WP	Tappo di Chiusura estremità tubo solo corpo Blanking End body only	Pr. Esercizio Max WP	Tappo di Chiusura estremi- tà tubo completo di dado Blanking End nut complete
				Codice / Part. nr.		Codice / Part. nr.
	mm	Inch	bar		bar	
L	6 L	M 12x1,5	315	529 610 001	315	529 600 001
L	8 L	M 14x1,5	315	529 610 002	315	529 600 002
L	10 L	M 16x1,5	315	529 610 003	315	529 600 003
L	12 L	M 18x1,5	315	529 610 004	315	529 600 004
L	15 L	M 22x1,5	315	529 610 005	315	529 600 005
L	18 L	M 26x1,5	315	529 610 006	315	529 600 006
L	22 L	M 30x2	160	529 610 007	160	529 600 007
L	28 L	M 36x2	160	529 610 008	160	529 600 008
L	35 L	M 45x2	160	529 610 009	160	529 600 009
L	42 L	M 52x2	160	529 610 010	160	529 600 010
S	6 S	M 14x1,5	630	529 610 011	630	529 600 011
S	8 S	M 16x1,5	630	529 610 012	630	529 600 012
S	10 S	M 18x1,5	630	529 610 013	630	529 600 013
S	12 S	M 20x1,5	630	529 610 014	630	529 600 014
S	14 S	M 22x1,5	630	529 610 015	630	529 600 015
S	16 S	M 24x1,5	400	529 610 016	400	529 600 016
S	20 S	M 30x2	400	529 610 017	400	529 600 017
S	25 S	M 36x2	400	529 610 018	400	529 600 018
S	30 S	M 42x2	400	529 610 019	400	529 600 019
S	38 S	M 52x2	315	529 610 020	315	529 600 020



Serie Series	Ø Esterno Tubo Tube OD		Attrezzo per premontaggio anelli Pre-assembly adaptor
			Codice / Part. nr.
LL	4 LL	●	519 500 001
LL	5 LL	●	519 500 002
LL	6 LL	●	519 500 003
LL	8 LL	●	519 500 004
L	6 L	●	519 500 005
L	8 L	●	519 500 006
L	10 L	●	519 500 007
L	12 L	●	519 500 008
L	15 L	●	519 500 009
L	18 L	●	519 500 010
L	22 L	●	519 500 011
L	28 L	●	519 500 012
L	35 L	●	519 500 013
L	42 L	●	519 500 014
S	6 S	●	519 500 015
S	8 S	●	519 500 016
S	10 S	●	519 500 017
S	12 S	●	519 500 018
S	14 S	●	519 500 019
S	16 S	●	519 500 020
S	20 S	●	519 500 021
S	25 S	●	519 500 022
S	30 S	●	519 500 023
S	38 S	●	519 500 024

TUBI RIGIDI E RACCORDI DIN
STEEL TUBES & DIN FITTINGS

COLLARI FERMA TUBO
CLAMPS



Ø Esterno Tubo Tube OD	Collare Singolo Standard in Polipropilene Completo Complete Polypropylene Standard Single Clamp		Collare Singolo Standard in Polipropilene solo corpo Body only Polypropylene Standard Single Clamp
mm	Codice / Part. nr.		Codice / Part. nr.
6	800 000 006	●	800 100 006
8	800 000 008	●	800 100 008
10	800 000 010	●	800 100 010
12	800 000 012	●	800 100 012
13,5	800 000 135	●	800 100 135
14	800 000 014	●	800 100 014
15	800 000 015	●	800 100 015
16	800 000 016	●	800 100 016
17,2	800 000 172	●	800 100 172
18	800 000 018	●	800 100 018
20	800 000 020	●	800 100 020
21,3	800 000 213	●	800 100 213
22	800 000 022	●	800 100 022
25	800 000 025	●	800 100 025
26,9	800 000 269	●	800 100 269
28	800 000 028	●	800 100 028
30	800 000 030	●	800 100 030
32	800 000 032	●	800 100 032
33,7	800 000 337	●	800 100 337
35	800 000 035	●	800 100 035
38	800 000 038	●	800 100 038
40	800 000 040	●	800 100 040
42,4	800 000 424	●	800 100 424
45	800 000 045	●	800 100 045
60,3	800 000 603	●	800 100 603

● Fornibile in 7 gg lavorativi / Available in 7 working days



Ø Esterno Tubo Tube OD	Collare Doppio Standard in Polipropilene Completo Complete Polypropylene Standard Double Clamp		Collare Doppio Standard in Polipropilene solo corpo Body only Polypropylene Standard Double Clamp
mm	Codice / Part. nr.		Codice / Part. nr.
6	801 000 006	●	801 100 006
8	801 000 008	●	801 100 008
10	801 000 010	●	801 100 010
12	801 000 012	●	801 100 012
13,5	801 000 135	●	801 100 135
14	801 000 014	●	801 100 014
15	801 000 015	●	801 100 015
16	801 000 016	●	801 100 016
17,2	801 000 172	●	801 100 172
18	801 000 018	●	801 100 018
20	801 000 020	●	801 100 020
21,3	801 000 213	●	801 100 213
22	801 000 022	●	801 100 022
25	801 000 025	●	801 100 025
26,9	801 000 269	●	801 100 269
28	801 000 028	●	801 100 028
30	801 000 030	●	801 100 030
32	801 000 032	●	801 100 032
33,7	801 000 337	●	801 100 337
35	801 000 035	●	801 100 035
38	801 000 038	●	801 100 038
40	801 000 040	●	801 100 040
42,4	801 000 424	●	801 100 424

● Fornibile in 7 gg lavorativi / Available in 7 working days



Ø Esterno Tubo Tube OD		Collare Singolo Pesante in Polipropilene Completo Complete Polypropylene Heavyweight Single Clamp		Collare Singolo Pesante in Alluminio Completo Complete Aluminium Heavyweight Single Clamp
mm		Codice / Part. nr.		Codice / Part. nr.
6	●	803 000 006	●	802 000 006
8	●	803 000 008	●	802 000 008
10	●	803 000 010	●	802 000 010
12	●	803 000 012	●	802 000 012
13,5	●	803 000 135	●	802 000 135
14	●	803 000 014	●	802 000 014
15	●	803 000 015	●	802 000 015
16	●	803 000 016	●	802 000 016
17,2	●	803 000 172	●	802 000 172
18	●	803 000 018	●	802 000 018
20	●	803 000 020	●	802 000 020
21,3	●	803 000 213	●	802 000 213
22	●	803 000 022	●	802 000 022
23	●	803 000 023	●	802 000 023
25	●	803 000 025	●	802 000 025
26,9	●	803 000 269	●	802 000 269
28	●	803 000 028	●	802 000 028
29	●	803 000 029	●	802 000 029
30	●	803 000 030	●	802 000 030
32	●	803 000 032	●	802 000 032
33,7	●	803 000 337	●	802 000 337
35	●	803 000 035	●	802 000 035
38	●	803 000 038	●	802 000 038
40	●	803 000 040	●	802 000 040
42,4	●	803 000 424	●	802 000 424
45	●	803 000 045	●	802 000 045
60,3	●	803 000 603	●	802 000 603



COMPONENTI OLEODINAMICI
HYDRAULICS COMPONENTS

INNESTI RAPIDI
QUICK RELEASE COUPLINGS

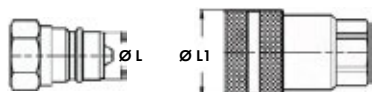

INTERCAMPIBILITÀ

- FASTER - NV
- STUCCHI - IR-V
- DNP - PDV1 / PDS
- PARKER - 4000

INTERCHANGEABILITY

- FASTER - NV
- STUCCHI - IR-V
- DNP - PDV1 / PDS
- PARKER - 4000



Filetto Thread	ØL Maschio Male ØL	Ø L1 Femmina Female Ø L1	Pressione Esercizio Working Pressure	Innesto Maschio Tenuta Valvola NVX NVX Male Shut-off Poppet Valve	Innesto Femmina Tenuta Valvola NVX NVX Female Shut-off Poppet Valve
Inch	mm	mm	bar	Codice / Part. nr.	Codice / Part. nr.
G 1/4"	14,3	27,6	350	701 310 004	701 410 004
G 3/8"	19	34	300	701 310 006	701 410 006
G 1/2"	20,6	38,5	300	701 300 008	701 400 008
G 3/4"	28	48,5	300	701 310 012	701 410 012
G 1"	31,3	56,2	250	701 310 016	701 410 016



INTERCAMPIBILITÀ

- FASTER - NV
- HSR - NVX
- DNP - PDV1 / PDS
- PARKER - 4000

INTERCHANGEABILITY

- FASTER - NV
- HSR - NVX
- DNP - PDV1 / PDS
- PARKER - 4000



Filetto Thread	Ø L Maschio Male Ø L	Ø L1 Femmina Female Ø L1	Pressione Esercizio Working Pressure	Innesto Maschio Tenuta Valvola IR-V IR-V Male Shut-off Poppet Valve	Innesto Femmina Tenuta Valvola IR-V IR-V Female Shut-off Poppet Valve
Inch	mm	mm	bar	Codice / Part. nr.	Codice / Part. nr.
G 1/4"	14,2	27	300	700 100 004	700 200 004
G 3/8"	19	34	300	700 100 006	700 200 006
G 1/2"	20,5	38	250	700 110 008	700 210 008
G 3/4"	26,9	48	250	700 100 012	700 200 012
G 1"	31,4	54	200	700 100 016	700 200 016

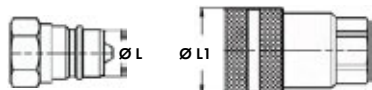

INTERCAMPIBILITÀ

- HSR - NVX
- STUCCHI - IR-V
- DNP - PDV1 / PDS
- PARKER - 4000

INTERCHANGEABILITY

- HSR - NVX
- STUCCHI - IR-V
- DNP - PDV1 / PDS
- PARKER - 4000



Filetto Thread	ØL Maschio Male ØL	Ø L1 Femmina Female Ø L1	Pressione Esercizio Working Pressure	Innesto Maschio Tenuta Valvola NV NV Male Shut-off Poppet Valve	Innesto Femmina Tenuta Valvola NV NV Female Shut-off Poppet Valve
Inch	mm	mm	bar	Codice / Part. nr.	Codice / Part. nr.
G 1/4"	14,1	27	350	703 300 004	703 400 004
G 3/8"	19	33	300	703 300 006	703 400 006
G 1/2"	20,5	38	300	703 310 008	703 410 008
G 3/4"	27,9	48	300	703 300 012	703 400 012
G 1"	31,3	56	250	703 300 016	703 400 016

TAPPI DI PROTEZIONE SERIE STANDARD

PLASTICA



PLASTIC



ALLUMINIO



ALLUMINIUM



Misura Size	Tappo Plastica per Innesto Maschio Standard For Standard Male Quick Coupling Plastic Cap	Tappo Plastica per Innesto Femmina Standard For Standard Female Quick Coupling Plastic Cap	Tappo Alluminio per Innesto Maschio Standard For Standard Male Quick Coupling Aluminium Cap	Tappo Alluminio per Innesto Femmina Standard For Standard Female Quick Coupling Aluminium Cap
Inch	Codice / Part. nr.	Codice / Part. nr.	Codice / Part. nr.	Codice / Part. nr.
G 1/4"	702 000 004	702 001 004	702 201 004	702 101 004
G 3/8"	702 000 006	702 001 006	702 201 006	702 101 006
G 1/2"	702 000 008	702 001 008	702 201 008	702 101 008
G 3/4"	702 000 012	702 001 012	702 201 012	702 101 012
G 1"	702 000 016	702 001 016	702 201 016	702 101 016



INTERCAMPIBILITÀ

- FASTER - ANV
- STUCCHI - BIR
- DNP - PAV1
- PARKER - 6600

INTERCHANGEABILITY

- FASTER - ANV
- STUCCHI - BIR
- DNP - PAV1
- PARKER - 6600



Filetto Thread	ØL Maschio Male ØL	Ø L1 Femmina Female Ø L1	Pressione Esercizio Working Pressure	Innesto Maschio Tenuta Valvola ANVX ANVX Male Shut-off Poppet Valve	Innesto Femmina Tenuta Valvola ANVX ANVX Female Shut-off Poppet Valve
Inch	mm	mm	bar	Codice / Part. nr.	Codice / Part. nr.
G 1/4"	11,9	26	350	701 300 004	701 400 004
G 3/8"	17,2	31,5	300	701 300 006	701 400 006
G 1/2"	20,6	38,5	300	701 300 008	701 400 008
G 3/4"	29,1	48	250	701 300 012	701 400 012
G 1"	34,3	56	250	701 300 016	701 400 016
G 1.1/4"	44,9	70	200	701 300 020	701 400 020
G 1.1/2"	55	84	120	701 300 024	701 400 024
G 2"	65	100	100	701 300 032	701 400 032

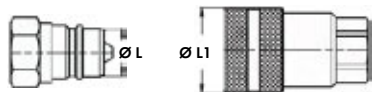

INTERCAMPIBILITÀ

- HSR - ANVX
- STUCCHI - BIR
- DNP - PAV1
- PARKER - 6600

INTERCHANGEABILITY

- HSR - ANVX
- STUCCHI - BIR
- DNP - PAV1
- PARKER - 6600



Filetto Thread	ØL Maschio Male ØL	Ø L1 Femmina Female Ø L1	Pressione Esercizio Working Pressure	Innesto Maschio Tenuta Valvola ANV ANV Male Shut-off Poppet Valve	Innesto Femmina Tenuta Valvola ANV ANV Female Shut-off Poppet Valve
Inch	mm	mm	bar	Codice / Part. nr.	Codice / Part. nr.
G 1/4"	11,8	25	500	703 310 004	703 410 004
G 3/8"	17,2	32	300	703 310 006	703 410 006
G 1/2"	20,5	38	300	703 310 008	703 410 008
G 3/4"	29	48	300	703 310 012	703 410 012
G 1"	34,3	56	250	703 310 016	703 410 016
G 1.1/4"	44,9	70	250	703 310 020	703 410 020
G 1.1/2"	55	84	200	703 310 024	703 410 024
G 2"	65	100	150	703 310 032	703 410 032

● Fornibile in 7 gg lavorativi / Available in 7 working days



INTERCAMPIBILITÀ

- FASTER - ANV
- HSR - ANVX
- DNP - PAV1
- PARKER - 6600

INTERCHANGEABILITY

- FASTER - ANV
- HSR - ANVX
- DNP - PAV1
- PARKER - 6600



Filetto Thread	Ø L Maschio Male Ø L	Ø L1 Femmina Female Ø L1	Pressione Esercizio Working Pressure	Innesto Maschio Tenuta Valvola BIR BIR Male Shut-off Poppet Valve	Innesto Femmina Tenuta Valvola BIR BIR Female Shut-off Poppet Valve
Inch	mm	mm	bar	Codice / Part. nr.	Codice / Part. nr.
G 1/4"	11,8	26	350	● 700 110 004	● 700 210 004
G 3/8"	17,3	31	300	● 700 110 006	● 700 210 006
G 1/2"	20,5	38	250	● 700 110 008	● 700 210 008
G 3/4"	29,1	48	250	● 700 110 012	● 700 210 012
G 1"	34,3	54	230	● 700 110 016	● 700 210 016
G 1.1/4"	45	65	230	● 700 110 020	● 700 210 020
G 1.1/2"	55	80	180	● 700 110 024	● 700 210 024
G 2"	65	100	130	● 700 110 032	● 700 210 032

TAPPI DI PROTEZIONE SERIE ISO 7241-1 Part A

PLASTICA



PLASTIC



Misura Size	Tappo Plastica per Innesto Maschio Standard For Standard Male Quick Coupling Plastic Cap	Tappo Plastica per Innesto Femmina Standard For Standard Female Quick Coupling Plastic Cap
Inch	Codice / Part. nr.	Codice / Part. nr.
G 1/4"	● 701 000 004	● 701 001 004
G 3/8"	● 701 000 006	● 701 001 006
G 1/2"	702 000 008	702 001 008
G 3/4"	● 701 000 012	● 701 001 012
G 1"	● 701 000 016	● 701 001 016

● Fornibile in 7 gg lavorativi / Available in 7 working days



INTERCAMPIBILITÀ

- FASTER - NS
- STUCCHI - IR
- DNP - PDS1
- PARKER - 4000

INTERCHANGEABILITY

- FASTER - NS
- STUCCHI - IR
- DNP - PDS1
- PARKER - 4000



Filetto Thread	ØL Maschio Male ØL	Ø L1 Femmina Female Ø L1	Pressione Esercizio Working Pressure	Innesto Maschio Tenuta Sfera NSX NSX Male Shut-off Ball Valve	Innesto Femmina Tenuta Sfera NSX NSX Female Shut-off Ball Valve
Inch	mm	mm	bar	Codice / Part. nr.	Codice / Part. nr.
G 1/4"	14,3	27,6	300	○ 701 100 004	○ 701 200 004
G 3/8"	19	34	300	○ 701 100 006	○ 701 200 006
G 1/2"	20,6	38,5	250	○ 701 100 008	○ 701 200 008
G 3/4"	28	48,5	250	○ 701 100 012	○ 701 200 012
G 1"	31,3	56,2	200	○ 701 100 016	○ 701 200 016



INTERCAMPIBILITÀ

- FASTER - NS
- HSR - NSX
- DNP - PDS1
- PARKER - 4000

INTERCHANGEABILITY

- FASTER - NS
- HSR - NSX
- DNP - PDS1
- PARKER - 4000



Filetto Thread	Ø L Maschio Male Ø L	Ø L1 Femmina Female Ø L1	Pressione Esercizio Working Pressure	Innesto Maschio Tenuta Valvola IR-S IR-S Male Shut-off Poppet Valve	Innesto Femmina Tenuta Valvola IR-S IR-S Female Shut-off Poppet Valve
Inch	mm	mm	bar	Codice / Part. nr.	Codice / Part. nr.
G 1/4"	14,2	27	300	○ 702 100 004	○ 702 200 004
G 3/8"	19	34	300	○ 702 100 006	○ 702 200 006
G 1/2"	20,5	38	250	○ 702 100 008	○ 702 200 008
G 3/4"	26,9	48	250	○ 702 100 012	○ 702 200 012
G 1"	31,4	54	200	○ 702 100 016	○ 702 200 016

INNESTI RAPIDI SERIE TV



INTERCAMPIBILITÀ

- HSR - NSX
- STUCCHI - IR
- DNP - PDS1
- PARKER - 4000

INTERCHANGEABILITY

- HSR - NSX
- STUCCHI - IR
- DNP - PDS1
- PARKER - 4000



Filetto Thread	ØL Maschio Male ØL	Ø L1 Femmina Female Ø L1	Pressione Esercizio Working Pressure	Innesto Maschio Tenuta Sfera NS NS Male Shut-off Ball Valve	Innesto Femmina Tenuta Sfera NS NS Female Shut-off Ball Valve
Inch	mm	mm	bar	Codice / Part. nr.	Codice / Part. nr.
G 1/4"	14,1	27	250	○ 703 100 004	○ 703 200 004
G 3/8"	18,9	33	250	○ 703 100 006	○ 703 200 006
G 1/2"	20,5	38	200	○ 703 100 008	○ 703 200 008
G 3/4"	27,9	48	170	○ 703 100 012	○ 703 200 012
G 1"	31,3	56	220	○ 703 100 016	○ 703 200 016

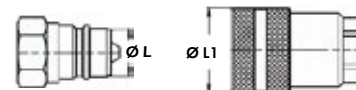

Filetto Thread	ØL Maschio Male ØL	Ø L1 Femmina Female Ø L1	Pressione Esercizio Working Pressure	Innesto Maschio Tenuta Valvola TV TV Male Shut-off Poppet Valve	Innesto Femmina Tenuta Valvola TV TV Female Shut-off Poppet Valve
Inch	mm	mm	bar	Codice / Part. nr.	Codice / Part. nr.
G 1/4"	14	27,2	350	○ 703 311 004	○ 703 411 004
G 3/8"	18,2	35,3	300	○ 703 311 006	○ 703 411 006
G 1/2"	22	42	250	○ 703 311 008	○ 703 411 008
G 3/4"	29,5	48,3	250	○ 703 311 012	○ 703 411 012
G 1"	36	58	200	○ 703 311 016	○ 703 411 016
G 1.1/4"	44	70	150	○ 703 311 020	○ 703 411 020
G 1.1/2"	53,5	80	120	● 703 311 024	● 703 411 024
G 2"			100	● 703 311 032	● 703 411 032

○ Fornibile a richiesta / Available on request

● Fornibile in 7 gg lavorativi / Available in 7 working days

○ Fornibile a richiesta / Available on request

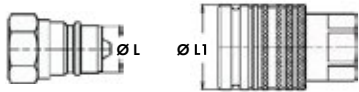

INTERCAMPIBILITÀ

- ISO 7241-1 Part A
- FASTER - CPV / CNV
- STUCCHI - IRS-V
- DNP - PPV / PPS
- PARKER - 4250

INTERCHANGEABILITY

- ISO 7241-1 Part A
- FASTER - CPV / CNV
- STUCCHI - IRS-V
- DNP - PPV / PPS
- PARKER - 4250



Filetto Thread	ØL Maschio Male ØL	Ø L1 Femmina Female Ø L1	Pressione Esercizio Working Pressure	Innesto Maschio Tenuta Valvola Push-Pull Filetto Femmina Pollici Male Push-Pull Shut-off Poppet Valve Inch Female Thread	Innesto Femmina Tenuta Valvola Push-Pull Filetto Femmina Pollici Female Push-Pull Shut-off Poppet Valve Inch Female Thread
Inch	mm	mm	bar	Codice / Part. nr.	Codice / Part. nr.
G 1/2"	20,6	38	300	701 310 008	701 410 008

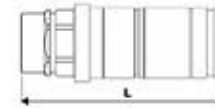

INTERCAMPIBILITÀ

ISO 7241-1 Part A

INTERCHANGEABILITY

ISO 7241-1 Part A



Filetto Thread	Lunghezza Length	Pressione Esercizio Working Pressure	Innesto Femmina Push-Pull 3CFPV Filetto Femmina Pollici 3CFPV Female Push-Pull Shut-off Inch Female Thread
Inch	mm	bar	Codice / Part. nr.
G 1/2"	107,2	250	701 411 008

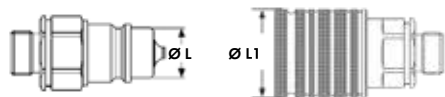

INTERCAMPIBILITÀ

- ISO 7241-1 Part A
- FASTER - CPV / CNV
- STUCCHI - IRS-V
- DNP - PPV / PPS
- PARKER - 4250

INTERCHANGEABILITY

- ISO 7241-1 Part A
- FASTER - CPV / CNV
- STUCCHI - IRS-V
- DNP - PPV / PPS
- PARKER - 4250



Filetto Thread	ØL Maschio Male ØL	Ø L1 Femmina Female Ø L1	Pressione Esercizio Working Pressure	Innesto Maschio Tenuta Valvola Push-Pull Filetto Maschio Metrico Male Push-Pull Shut-off Poppet Valve Metric Male Thread	Innesto Femmina Tenuta Valvola Push-Pull Filetto Maschio Metrico Female Push-Pull Shut-off Poppet Valve Metric Male Thread
mm	mm	mm	bar	Codice / Part. nr.	Codice / Part. nr.
10L - M 16x1,5	20,6	38	300	701 310 162	701 410 162
12L - M 18x1,5	20,6	38	300	701 310 182	701 410 182
15L - M 22x1,5	20,6	38	300	701 310 222	701 410 222

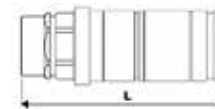

INTERCAMPIBILITÀ

ISO 7241-1 Part A

INTERCHANGEABILITY

ISO 7241-1 Part A



Filetto Thread	Lunghezza Length	Pressione Esercizio Working Pressure	Innesto Femmina Push-Pull 4SRPV Filetto Femmina Pollici 4SRPV Female Push-Pull Shut-off Inch Female Thread
Inch	mm	bar	Codice / Part. nr.
G 1/2"	109	250	701 412 008



INTERCAMPIBILITÀ

- FASTER - FFH
- STUCCHI - FIRG / A
- DNP - PLT1 / PLT4
- PARKER - FEM

INTERCHANGEABILITY

- FASTER - FFH
- STUCCHI - FIRG / A
- DNP - PLT1 / PLT4
- PARKER - FEM



Filetto Thread	ØL Maschio Male ØL	Ø L1 Femmina Female Ø L1	Pressione Esercizio Working Pressure	Innesto Maschio tenuta Faccia Piana FFX FFX Male Shut-off Flat Face	Innesto Femmina Tenuta Faccia Piana FFX FFX Female Shut-off Flat Face
Inch	mm	mm	bar	Codice / Part. nr.	Codice / Part. nr.
G 1/4"	16,2	28	350	701 600 004	701 500 004
G 3/8"	19,8	32	300	701 600 006	701 500 006
G 1/2"	19,8	32	300	701 601 008	701 501 008
G 1/2"	24,6	38	300	701 600 008	701 500 008
G 3/4"	24,6	38	300	701 601 012	701 501 012
G 3/4"	27	42	250	701 600 012	701 500 012
G 1"	30	48	250	701 600 016	701 500 016
G 1.1/4"	36	55	250	701 600 020	701 500 020
G 1.1/2"	57	80	200	701 600 024	701 500 024

INTERCAMPIBILITÀ

- HSR - FFX
- STUCCHI - FIRG / A
- DNP - PLT1 / PLT4
- PARKER - FEM

INTERCHANGEABILITY

- HSR - FFX
- STUCCHI - FIRG / A
- DNP - PLT1 / PLT4
- PARKER - FEM



Filetto Thread	ØL Maschio Male ØL	Ø L1 Femmina Female Ø L1	Pressione Esercizio Working Pressure	Innesto Maschio Tenuta Valvola NV NV Male Shut-off Poppet Valve	Innesto Femmina Tenuta Valvola NV NV Female Shut-off Poppet Valve
Inch	mm	mm	bar	Codice / Part. nr.	Codice / Part. nr.
G 1/4"	16,1	27	350	703 600 004	703 500 004
G 3/8"	19,7	30	350	703 600 006	703 500 006
G 1/2"	19,7	30	350	703 601 008	703 501 008
G 1/2"	24,5	38	350	703 600 008	703 500 008
G 3/4"	24,5	38	350	703 601 012	703 501 012
G 3/4"	29,95	48	350	703 600 012	703 500 012
G 1"	29,95	48	350	703 601 016	703 501 016
G 1"	36	55	350	703 600 016	703 500 016
G 1.1/4"	36	55	350	703 600 020	703 500 020

• Fornibile in 7 gg lavorativi / Available in 7 working days



INTERCAMPIBILITÀ

- FASTER - FFH
- HSR - FFX
- DNP - PLT1 / PLT4
- PARKER - FEM

INTERCHANGEABILITY

- FASTER - FFH
- HSR - FFX
- DNP - PLT1 / PLT4
- PARKER - FEM



Filetto Thread	ØL Maschio Male ØL	Ø L1 Femmina Female Ø L1	Pressione Esercizio Working Pressure	Innesto Maschio Tenuta Faccia Piana FIRG FIRG Male Shut-off Flat Face	Innesto Femmina Tenuta Faccia Piana FIRG FIRG Female Shut-off Flat Face
Inch	mm	mm	bar	Codice / Part. nr.	Codice / Part. nr.
G 1/4"	16,1	28	300	700 600 004	700 500 004
G 3/8"	19,7	32	300	700 600 006	700 500 006
G 1/2"	19,7	32	300	700 600 008	700 500 008
G 1/2"	24,5	38	250	700 601 008	700 501 008
G 3/4"	24,5	38	250	700 600 012	700 500 012
G 3/4"	30	48	330	700 601 012	700 501 012
G 1"	30	48	250	700 600 016	700 500 016
G 1.1/4"	36	55	250	700 600 020	700 500 020
G 1.1/2"	57	80	200	700 600 024	700 500 024
G 2"	73	100	200	700 600 032	700 500 032

TAPPI DI PROTEZIONE

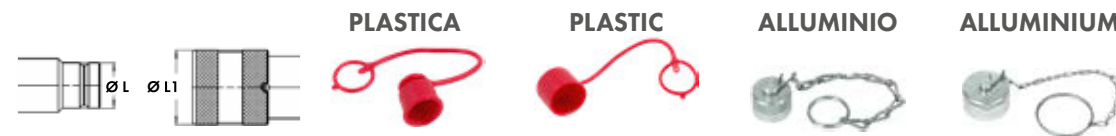

Misura Size	ØL Maschio Male ØL	Ø L1 Femmina Female Ø L1	Tappo Plastica per Innesto Maschio Faccia Piana For Flat Face Male Quick Coupling Plastic Cap	Tappo Plastica per Innesto Femmina Faccia Piana Flat Face Female Quick Coupling Plastic Cap	Tappo Alluminio per Innesto Maschio Faccia Piana Flat Face Male Quick Coupling Aluminium Cap	Tappo Alluminio per Innesto Femmina Faccia Piana Flat Face Female Quick Coupling Aluminium Cap
Inch	mm	mm	Codice / Part. nr.	Codice / Part. nr.	Codice / Part. nr.	Codice / Part. nr.
G 1/4"	16,1	27	703 001 004	703 000 004	703 101 004	703 201 004
G 3/8"	19,7	30	703 001 006	703 000 006	703 101 006	703 201 006
G 1/2"	24,5	38	703 001 008	703 000 008	703 101 008	703 201 008
G 3/4"	29,95	48	703 001 012	703 000 012	703 101 012	703 201 012
G 1"	36	55	703 001 016	703 000 016	703 101 016	703 201 016

• Fornibile in 7 gg lavorativi / Available in 7 working days



**INNESTI
SERIE
2FFI**

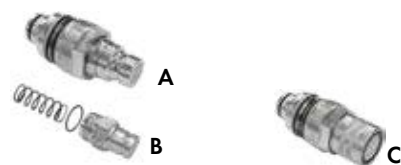

Filetto Thread	Blocco Completo Vecchia Generazione 4BD4FI12 Old Generation Complete Quick Release Coupling 4BD4FI12	Filetto Thread	Pressione Esercizio Working Pressure	Parte di Ricambio Maschio Male Spare Parts	Parte di Ricambio Femmina Female Spare Parts
Inch	Codice / Part. nr.	Inch	bar	Codice / Part. nr.	Codice / Part. nr.
G 1/2"	703 121 334	G 3/8"	250	703 640 138 B	703 540 120 A
		G 1/2"	250	703 640 120 C	703 540 120 A



**INNESTI
SERIE
FFH**

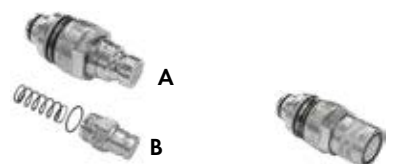

Filetto Thread	Blocco Completo Nuova Generazione 4BD4FH08 New Generation Complete Quick Release Coupling 4BD4FH08	Filetto Thread	Pressione Esercizio Working Pressure	Parte di Ricambio Maschio Male Spare Parts	Parte di Ricambio Femmina Female Spare Parts
Inch	Codice / Part. nr.	Inch	bar	Codice / Part. nr.	Codice / Part. nr.
G 1/2"	704 121 334	G 3/8"	350	704 640 138 B	704 540 120 A
		G 1/2"	350	704 640 120 C	704 540 120 A

● Fornibile in 7 gg lavorativi / Available in 7 working days



INTERCAMPIBILITÀ

- FASTER - FFH
- HSR - FFX
- DNP - PLT1 / PLT4
- PARKER - FEM

INTERCHANGEABILITY

- FASTER - FFH
- HSR - FFX
- DNP - PLT1 / PLT4
- PARKER - FEM

Filetto Thread	ØL Maschio Male ØL	Ø L1 Femmina Female Ø L1	Pressione Esercizio Working Pressure	Innesto Maschio Tenuta Faccia Piana FIRG Filetto UNF FIRG Male Shut-off Flat Face UNF Thread	Innesto Femmina Tenuta Faccia Piana FIRG Filetto UNF FIRG Female Shut-off Flat Face UNF Thread
Inch	mm	mm	bar	Codice / Part. nr.	Codice / Part. nr.
9/16" UNF	16,1	28	300	700 610 006	700 510 006
3/4" UNF	19,7	32	300	700 610 008	700 510 008
7/8" UNF	19,7	32	300	700 610 010	700 510 010
1.1/16" UNF	24,5	38	250	700 610 012	700 510 012
1.5/16" UNF	30	48	250	700 610 016	700 510 016
1.5/8" UNF	36	55	250	700 610 020	700 510 020
1.7/8" UNF	57	80	200	700 610 024	700 510 024

INTERCAMPIBILITÀ

- HSR - FFX
- STUCCHI - FIRG / A
- DNP - PLT1 / PLT4
- PARKER - FEM

INTERCHANGEABILITY

- HSR - FFX
- STUCCHI - FIRG / A
- DNP - PLT1 / PLT4
- PARKER - FEM



Filetto Thread	ØL Maschio Male ØL	Ø L1 Femmina Female Ø L1	Pressione Esercizio Working Pressure	Innesto Maschio Tenuta Faccia Piana FFH Filetto UNF FFH Male Shut-off Flat Face UNF Thread	Innesto Femmina Tenuta Faccia Piana FFH Filetto UNF FFH Female Shut-off Flat Face UNF Thread
Inch	mm	mm	bar	Codice / Part. nr.	Codice / Part. nr.
3/4" UNF	19,7	30	350	703 610 008	703 510 008
7/8" UNF	24,5	38	350	703 610 010	703 510 010
1.1/16" UNF	24,5	38	350	703 610 012	703 510 012

● Fornibile in 7 gg lavorativi / Available in 7 working days

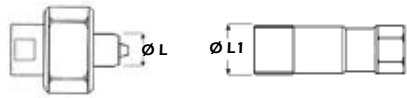

Filetto Thread	ØL Maschio Male ØL	Ø L1 Femmina Female Ø L1	Pressione Esercizio Working Pressure	Innesto Maschio a Vite Tenuta a Valvola SM SM Screw Male Shut-off Popet Valve	Innesto Femmina a Vite Tenuta a Valvola SF SF Screw Femal Shutoff Popet Valve
Inch	mm	mm	bar	Codice / Part. nr.	Codice / Part. nr.
G 1/4"		31	450	706 300 004	706 400 004
G 3/8"		38	400	706 300 006	706 400 006
G 1/2"		47	350	706 300 008	706 400 008
G 3/4"		56	300	706 300 012	706 400 012
G 1"		67	300	706 300 016	706 400 016
G 1.1/4"		79	250	706 300 020	706 400 020
G 1.1/2"		90	220	706 300 024	706 400 024
G 2"		128	150	706 300 032	706 400 032

TAPPI DI PROTEZIONE

ALLUMINIO



ALLUMINIUM



Misura Size	Tappo Alluminio per Innesto Maschio a Vite For Screw Male Quick Coupling Aluminium Cap	Tappo Alluminio per Innesto Femmina a Vite For Screw Female Quick Coupling Aluminium Cap
Inch	Codice / Part. nr.	Codice / Part. nr.
G 1/4"	706 301 004	706 401 004
G 3/8"	706 301 006	706 401 006
G 1/2"	706 301 008	706 401 008
G 3/4"	706 301 012	706 401 012
G 1"	706 301 016	706 401 016
G 1.1/4"	706 301 020	706 401 020
G 1.1/2"	706 301 024	706 401 024
G 2"	706 301 032	706 401 032

● Fornibile in 7 gg lavorativi / Available in 7 working days

IDONEO PER APPLICAZIONI GRAVOSE
HEAVY DUTY APPLICATIONS

TAPPI PARAPOLVERE INCLUSI
Dust Protection Included

INTERCAMPIBILITÀ

• RoFLEX Hochdruck

INTERCHANGEABILITY

• RoFLEX Hochdruck

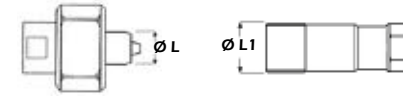

Filetto Thread	ØL Maschio Male ØL	Ø L1 Femmina Female Ø L1	Pressione Esercizio Working Pressure	Innesto Maschio a Vite per applicazioni Pesanti Heavy Duty Screw Male Shut-off	Innesto Femmina a Vite per applicazioni Pesanti Heavy Duty Screw Female Shut-off
Inch	mm	mm	bar	Codice / Part. nr.	Codice / Part. nr.
G 3/8"	22	F25,6x3	500	708 300 006	708 400 006
G 1/2"	26	F39,6x3	450	708 300 008	708 400 008
G 3/4"	30	F44,7x3	400	708 300 012	708 400 012
G 1"	40	F57,6x4	350	708 300 016	708 400 016
G 1.1/4"	48	F74,5x5	320	708 300 020	708 400 020
G 1.1/2"	55	F74,5x5	300	708 300 024	708 400 024



● Fornibile in 7 gg lavorativi / Available in 7 working days

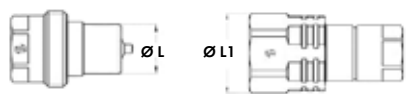

Filetto Thread	ØL Maschio Male ØL	Ø L1 Femmina Female Ø L1	Pressione Esercizio Working Pressure	Innesto Maschio a Vite Tenuta a Valvola VV VV Screw Male Shut-off Popet Valve	Innesto Femmina a Vite Tenuta a Valvola VV VV Screw Female Shut-off Popet Valve
Inch	mm	mm	bar	Codice / Part. nr.	Codice / Part. nr.
G 1/4"	14,1	30	350	● 707 300 004	● 707 400 004
G 3/8"	18,9	38	300	● 707 300 006	● 707 400 006
G 1/2"	20,5	42	300	707 300 008	707 400 008
G 3/4"	27,9	55	250	707 300 012	707 400 012
G 1"	31,8	61	220	707 300 016	707 400 016

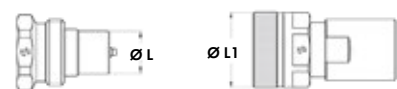

Filetto Thread	ØL Maschio Male ØL	Ø L1 Femmina Female Ø L1	Pressione Esercizio Working Pressure	Innesto Maschio a Vite Tenuta a Valvola VVS VVS Screw Male Shut-off Popet Valve	Innesto Femmina a Vite Tenuta a Valvola VVS VVS Screw Female Shut-off Popet Valve
Inch	mm	mm	bar	Codice / Part. nr.	Codice / Part. nr.
G 1/4"	14,1	30	800	● 706 310 004	● 706 410 004
G 3/8"	18,9	40	800	● 706 310 006	● 706 410 006
G 1/2"	20,5	45	700	706 310 008	706 410 008
G 3/4"	27,9	55	700	● 706 310 012	● 706 410 012
G 1"	31,3	60	630	706 310 016	706 410 016
G 1.1/4"	43,9	80	600	● 706 310 020	● 706 410 020
G 1.1/2"	53,4	98	400	● 706 310 024	● 706 410 024
G 2"	81,9	129	350	● 706 310 032	● 706 410 032

● Fornibile in 7 gg lavorativi / Available in 7 working days

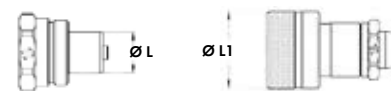

Filetto Thread	ØL Maschio Male ØL	Ø L1 Femmina Female Ø L1	Pressione Esercizio Working Pressure	Innesto Maschio a Vite Tenuta a Valvola A.P. H.P. Screw Male Shut-off Popet Valve	Innesto Femmina a Vite Tenuta a Valvola A.P. H.P. Screw Female Shut-off Popet Valve
Inch	mm	mm	bar	Codice / Part. nr.	Codice / Part. nr.
1/4" NPT			720	● 707 320 004	● 707 420 004
3/8" NPT			720	● 707 320 006	● 707 420 006



Filetto Thread	ØL Maschio Male ØL	Ø L1 Femmina Female Ø L1	Pressione Esercizio Working Pressure	Innesto Maschio a Vite Tenuta a Valvola PVV PVV Screw Male Shut-off Popet Valve	Innesto Femmina a Vite Tenuta a Valvola PVV PVV Screw Female Shut-off Popet Valve
Inch	mm	mm	bar	Codice / Part. nr.	Codice / Part. nr.
1/4" NPT	15,8	33	1030	707 310 004	707 410 004
3/8" NPT	19	36	1000	● 707 310 006	● 707 410 006

● Fornibile in 7 gg lavorativi / Available in 7 working days



ATTACCO FILETTO FEMMINA
Female Connection

INTERCAMPIBILITÀ

- CEJN - 115
- PARKER - HP

INTERCHANGEABILITY

- CEJN - 115
- PARKER - HP

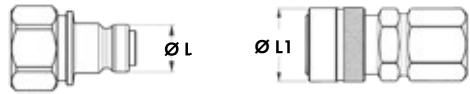

Filetto Thread	ØL Maschio Male ØL	Ø L1 Femmina Female Ø L1	Pressione Esercizio Working Pressure	Innesto Maschio Tenuta Faccia Piana C5 C5 Male Shut-off Flat Face	Innesto Femmina Tenuta Faccia Piana C5 C5 Female Shut-off Flat Face
Inch	mm	mm	bar	Codice / Part. nr.	Codice / Part. nr.
G 1/8"	14,9	28	1000	• 707 500 002	• 707 600 002
G 1/4"	14,9	28	1000	• 707 500 004	• 707 600 004
G 3/8"	14,9	28	1000	• 707 500 006	• 707 600 006
1/4" NPT	14,9	28	1000	• 707 501 004	• 707 601 004
3/8" NPT	14,9	28	1000	• 707 501 006	• 707 601 006

ATTACCO FILETTO MASCHIO
Male Connection

INTERCAMPIBILITÀ

- CEJN - 115
- PARKER - HP

INTERCHANGEABILITY

- CEJN - 115
- PARKER - HP

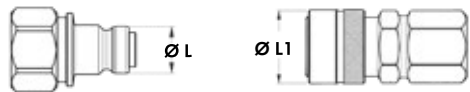

Filetto Thread	ØL Maschio Male ØL	Ø L1 Femmina Female Ø L1	Pressione Esercizio Working Pressure	Innesto Maschio Tenuta Faccia Piana C5 C5 Male Shut-off Flat Face	Innesto Femmina Tenuta Faccia Piana C5 C5 Female Shut-off Flat Face
Inch	mm	mm	bar	Codice / Part. nr.	Codice / Part. nr.
G 1/4"	14,9	28	1000	• 707 700 004	• 707 800 004
G 3/8"	14,9	28	1000	• 707 700 006	• 707 800 006
1/4" NPT	14,9	28	1000	• 707 701 004	• 707 801 004
3/8" NPT	14,9	28	1000	• 707 701 006	• 707 801 006

• Fornibile in 7 gg lavorativi / Available in 7 working days



SPECIFICO PER IDROPULTRICI
Cleaner Specific

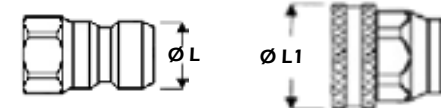

Filetto Thread	ØL Maschio Male ØL	Ø L1 Femmina Female Ø L1	Pressione Esercizio Working Pressure	Innesto Maschio in Acciaio Passaggio Libero Steel Free Pass Male	Innesto Femmina in Ottone Passaggio Libero Brass Free Pass Female
Inch	mm	mm	bar	Codice / Part. nr.	Codice / Part. nr.
G 3/8"		33	250	* 700 790 006	* 700 890 006

* Fornibile anche in Acciaio Inox / Also Stainless Steel available

SERIE STANDARD PASSAGGIO LIBERO
Free Pass Standard Series

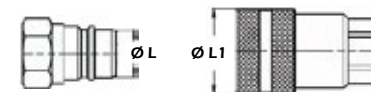

Filetto Thread	ØL Maschio Male ØL	Ø L1 Femmina Female Ø L1	Pressione Esercizio Working Pressure	Innesto Maschio Standard Passaggio Libero Standard Free Pass Male	Innesto Femmina Standard Passaggio Libero Standard Free Pass Female
Inch	mm	mm	bar	Codice / Part. nr.	Codice / Part. nr.
G 1/4"	14,3	27,6	350	• 700 790 004	• 700 890 004
G 1/2"	20,6	38,5	300	• 700 790 008	• 700 890 008
G 3/4"	28	48,5	300	• 700 790 012	• 700 890 012
G 1"	31,3	56,2	250	• 700 790 016	• 700 890 016

• Fornibile in 7 gg lavorativi / Available in 7 working days



COMPONENTI OLEODINAMICI
HYDRAULICS COMPONENTS

VALVOLE - GIUNTI GIREVOLI - DISTRIBUTORI
VALVES - SWIVEL JOINTS - DISTRIBUTORS



FORI DI FISSAGGIO
Fixing Hole



Filetto Thread	Valvola a Sfera 2 vie Alta Pressione con Fori di Fissaggio High Pressure 2 ways Ball Valve with Fixing Hole	Pressione Esercizio Working Pressure	Valvola a Sfera 3 vie Alta Pressione con Fori di Fissaggio Schema a "L" High Pressure 3 ways Ball Valve with Fixing Hole "L" Type	Pressione Esercizio Working Pressure
Inch	Codice / Part. nr.	bar	Codice / Part. nr.	bar
G 1/4"	632 020 140	500 ●	634 100 140	500
G 3/8"	632 020 380	500 ●	634 100 380	400
G 1/2"	632 020 120	400 ●	634 100 120	400
G 3/4"	632 020 340	315 ●	634 100 340	350
G 1"	632 020 100	315 ●	634 100 100	350

FORI DI FISSAGGIO
Fixing Hole



Filetto Thread	Valvola a Sfera 2 vie Alta Pressione High Pressure 2 ways Ball Valve	Pressione Esercizio Working Pressure	Valvola a Sfera 3 vie Alta Pressione Schema a "T" High Pressure 3 ways Ball Valve "T" Type	Pressione Esercizio Working Pressure
Inch	Codice / Part. nr.	bar	Codice / Part. nr.	bar
G 1/4"	632 000 140	500 ●	633 000 140	400
G 3/8"	632 000 380	500 ●	633 000 380	400
G 1/2"	632 000 120	500 ●	633 000 120	350
G 3/4"	632 000 340	400 ●	633 000 340	350
G 1"	632 000 100	350 ●	633 000 100	300
G 1.1/4"	632 000 114	350 ●	633 000 114	300
G 1.1/2"	632 000 112	350 ●	633 000 112	300
G 2"	632 000 200	210 ●		

● Fornibile in 7 gg lavorativi / Available in 7 working days

**MANIGLIA
 ACCIAIO**
**Handle Chromed
 Steel**



Filetto Thread	Valvola a Sfera 2 vie Bassa Pressione F/F Maniglia in Acciaio F/F Low Pressure 2 ways Ball Valve Handle in chromed steel	Pressione Esercizio Working Pressure	Valvola a Sfera 2 vie Bassa Pressione M/F Maniglia in Acciaio M/F Low Pressure 2 ways Ball Valve Handle in chromed steel	Pressione Esercizio Working Pressure
Inch	Codice / Part. nr.	bar	Codice / Part. nr.	bar
G 1/4"	●* 638 000 140	55 ●	638 100 140	40
G 3/8"	* 638 000 380	55	638 100 380	40
G 1/2"	* 638 000 120	45	638 100 120	40
G 3/4"	* 638 000 340	45 ●	638 100 340	40
G 1"	* 638 000 100	40	638 100 100	40
G 1.1/4"	* 638 000 114	30	638 100 114	40
G 1.1/2"	* 638 000 112	30	638 100 112	40
G 2"	* 638 000 200	30	638 100 200	40
G 2.1/2"	●* 638 000 212	35 ●	638 100 212	40
G 3"	●* 638 000 300	35 ●	638 100 300	40
G 4"	●* 638 000 400	30 ●	638 100 400	40

● Fornibile in 7 gg lavorativi / Available in 7 working days

* Fornibile anche in Acciaio Inox / Also Stainless Steel available



Filetto Thread	Saracinesca Tipo Normale PN16 Normal Brass Gate Valve PN16	Pressione Esercizio Working Pressure	Valvola a Sfera 2 vie Bassa Pressione con Farfalla PN40 Low Pressure 2 ways Ball Valve with T handle PN40	Pressione Esercizio Working Pressure
Inch	Codice / Part. nr.	bar	Codice / Part. nr.	bar
G 1/4"	637 000 140	16	640 000 140	40
G 3/8"	637 000 380	16	640 000 380	40
G 1/2"	637 000 120	16	640 000 120	40
G 3/4"	637 000 340	16	640 000 340	40
G 1"	637 000 100	16	640 000 100	40
G 1.1/4"	637 000 114	16	640 000 114	40
G 1.1/2"	637 000 112	16		
G 2"	637 000 200	16		
G 2.1/2"	637 000 212	16		
G 3"	637 000 300	16		
G 4"	632 050 400	16		



Filetto Thread	Diametro Portagomma Connector Diameter	Valvola a Sfera con Portagomma e Lancia Lavaggio Ball valve with hose connector and hose pipe nozzle
Inch	Inch	Codice / Part. nr.
G 1/2"	20	639 000 120
G 3/4"	25	639 000 340

● Fornibile in 7 gg lavorativi / Available in 7 working days



MANIGLIA ALLUMINIO Aluminium Handle



Filetto Thread	Valvola a Sfera Mini PN10 Femmina/Femmina Mini Ball Valve Female/Female PN10	Pressione Esercizio Working Pressure	Valvola a Sfera Mini PN10 Maschio/Femmina Mini Ball Valve Male/Female PN10	Pressione Esercizio Working Pressure
Inch	Codice / Part. nr.	bar	Codice / Part. nr.	bar
G 1/4"	606 500 140	10	606 600 140	10
G 3/8"	606 500 380	10	606 600 380	10
G 1/2"	606 500 120	10	606 600 120	10

MANIGLIA PLASTICA Plastic Handle



Filetto Thread	Valvola a Sfera Mini PN20 Femmina/Femmina Mini Ball Valve Female/Female PN20	Pressione Esercizio Working Pressure	Valvola a Sfera Mini PN20 Maschio conico/Femmina Mini Ball Valve Male BSPT/Female PN20	Pressione Esercizio Working Pressure
Inch	Codice / Part. nr.	bar	Codice / Part. nr.	bar
G 1/8"	630 000 180	20	631 000 180	20
G 1/4"	630 000 140	20	631 000 140	20
G 3/8"	630 000 380	20	631 000 380	20
G 1/2"	630 000 120	20	631 000 120	20
G 3/4"	630 000 340	20	631 000 340	20

● Fornibile in 7 gg lavorativi / Available in 7 working days



Filetto Thread	Giunti Girevole in Linea In Line Swivel Joint	Pressione Esercizio Working Pressure	Giunti Girevolea 90° 90 degree Swivel Joint	Pressione Esercizio Working Pressure
Inch	Codice / Part. nr.	bar	Codice / Part. nr.	bar
G 1/4"	710 000 140	400	790 000 140	400
G 3/8"	710 000 380	400	790 000 380	400
G 1/2"	710 000 120	300	790 000 120	300
G 3/4"	710 000 340	300	790 000 340	300
G 1"	710 000 100	300	790 000 100	300
G 1.1/4"	710 000 114	300	790 000 114	300
G 1.1/2"	710 000 112	300	790 000 112	300
G 2"	710 000 200	250	790 000 200	250

DEVIATORI DI FLUSSO ALTA PRESSIONE



Filetto Thread	Deviatore di Flusso 3 vie in Ghisa Iron Cast 3 ways Diverter Valve	Pressione Esercizio Working Pressure	Deviatore di Flusso 4 vie in Ghisa Iron Cast 4 ways Diverter Valve	Pressione Esercizio Working Pressure
Inch	Codice / Part. nr.	bar	Codice / Part. nr.	bar
G 3/8"	635 000 380	400	636 000 380	250
G 1/2"	635 000 120	350	636 000 120	350
G 3/4"	635 000 340	350	636 000 340	350
G 1"	635 000 100	300	636 000 100	300
G 1.1/2"	635 000 112	200		

● Fornibile in 7 gg lavorativi / Available in 7 working days

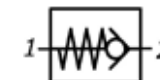

Filetto Thread	Pressione Esercizio Working Pressure	Pressione Apertura Opening Pressure	Valvola Unidirezionale di Non Ritorno VU Check Valve Poppet Type VU
Inch	bar	bar	Codice / Part. nr.
G 1/4"	400	0,5	641 000 140
G 3/8"	400	0,5	641 000 380
G 1/2"	350	0,5	641 000 120
G 3/4"	300	0,5	641 000 340
G 1"	300	0,5	641 000 100
G 1.1/4"	250	0,5	641 000 114
G 1.1/2"	230	0,5	641 000 112

VALVOLE A PARACADUTE



Filetto Thread	Valvola Unidirezionale con Blocco Automatico Hose Burst Valves Cartridge	Pressione Esercizio Working Pressure	Collettore Maschio/Femmina per Valvola a Paracadute Male/Female Stud Bolt for Valve Cartridge	Collettore Femmina/Femmina per Valvola a Paracadute Female/Female Stud Bolt for Valve Cartridge
Inch	Codice / Part. nr.	bar	Codice / Part. nr.	Codice / Part. nr.
G 1/4"	642 000 140	350	642 100 140	642 200 140
G 3/8"	642 000 380	350	642 100 380	642 200 380
G 1/2"	642 000 120	350	642 100 120	642 200 120
G 3/4"	642 000 340	350	642 100 340	642 200 340

● Fornibile in 7 gg lavorativi / Available in 7 working days



Corpo Body	Attacco DIN 2353 DIN 2353 Connection	Valvola di Ritegno Pilotata Doppio Effetto Pilot Check Valve Double Action	Pressione Esercizio Working Pressure
Inch	Size	Codice / Part. nr.	bar
G 3/8"	12L	648 038 012	300
G 1/2"	15L	648 012 015	300

VALVOLE REGOLAZIONE FLUSSO



Filetto Thread	Valvola regolazione flusso unidirezionale a manicotto Barrel flow control Valve with check	Pressione Esercizio Working Pressure	Flusso bidirezionale a manicotto Barrel Flow Control Valve NO Check	Pressione Esercizio Working Pressure
Inch	Codice / Part. nr.	bar	Codice / Part. nr.	bar
G 1/4"	643 000 140	300	644 000 140	300
G 3/8"	643 000 380	300	644 000 380	300
G 1/2"	643 000 120	300	644 000 120	300
G 3/4"	• 643 000 340	250	• 644 000 340	250
G 1"	• 643 000 100	250	• 644 000 100	250

• Fornibile in 7 gg lavorativi / Available in 7 working days



**CORPO IN ACCIAIO
Steel Body**



Filetto Thread	Valvola Regolazione Flusso Unidirezionale FT 257/5 Oneway Flow Regulator Valve FT 257/5	Pressione Esercizio Working Pressure	Valvola Regolazione Flusso Bidirezionale FT 257/2 Flow Regulator Valve FT 257/2	Pressione Esercizio Working Pressure
Inch	Codice / Part. nr.	bar	Codice / Part. nr.	bar
G 1/4"	602 575 140	400	602 572 140	400
G 3/8"	602 575 380	400	602 572 380	400
G 1/2"	602 575 120	400	• 602 572 120	400
G 3/4"	602 575 340	400	• 602 572 340	400
G 1"	602 575 100	320	• 602 572 100	320
G 1.1/4"	• 602 575 114	320	• 602 572 114	320
G 1.1/2"	• 602 575 112	320	• 602 572 112	320
G 2"	• 602 575 200	320	• 602 572 200	320

**CORPO IN OTTONE
Brass Body**



Filetto Thread	Valvola Regolazione Flusso Unidirezionale FT 1251/5 Oneway Flow Regulator Valve FT 1251/5	Pressione Esercizio Working Pressure	Valvola Regolazione Flusso Bidirezionale FT 1251/2 Flow Regulator Valve FT 1251/2	Pressione Esercizio Working Pressure
Inch	Codice / Part. nr.	bar	Codice / Part. nr.	bar
G 1/4"	601 251 514	210	• 601 251 214	210
G 3/8"	601 251 538	210	• 601 251 238	210
G 1/2"	601 251 512	210	• 601 251 212	210
G 3/4"	• 601 251 534	210	• 601 251 234	210
G 1"	• 601 251 510	210	• 601 251 210	210

• Fornibile in 7 gg lavorativi / Available in 7 working days



Filetto Thread	Strozzatore di flusso bidirezionale economico Cheap FlowBi-directional restrictor
Inch	Codice / Part. nr.
G 3/8"	648 038 012
G 1/2"	648 012 015

DISTRIBUTORI MONOBLOCCO

DOPPIO EFFETTO
Double Effect



Double Effect	Pressione Max Max Pressure	Portata Capacity		Distributore Doppio Effetto a 1 Leva 1 Lever Distributor	Distributore Doppio Effetto a 2 Leve 2 Levers Distributor	Distributore Doppio Effetto a 3 Leve 3 Levers Distributor
Inch	bar	lt		Codice / Part. nr.	Codice / Part. nr.	Codice / Part. nr.
G 3/8"	180	40	●	660 381 040	660 382 040	660 383 040
G 1/2"	180	80	●	660 121 040	660 122 040	660 123 040
G 3/4"	320	130	●	660 134 040		



Filetto Thread	Spia Olio in Alluminio Aluminium Oil Level Plug
Inch	Codice / Part. nr.
G 1/4"	646 000 140
G 3/8"	646 000 380
G 1/2"	646 000 120
G 3/4"	646 000 340



Interasse Fori holes Interaxes	Indicatore di Livello Visivo Visual Level Indicator
mm	Codice / Part. nr.
76	646 000 076
127	646 000 127

KIT TERZO PUNTO
Kit Top Links



Tubi 2SN 2SN Hose	Lunghezza 1° Tubo First Hose Length	Lunghezza 2° Tubo Second Hose Length	1° Raccordo First Fitting	2° Raccordo Second Fitting	Kit Collegamento 3° Punto Idraulico completo Complete Kit for Hydraulic Top Links
Inch	mm	mm	mm	mm	Codice / Part. nr.
3/8"	900	900	F.90 + Nip. 3/8"	M. + Inn. M. a valvola 1/2"	647 000 900
3/8"	900	1400	F.90 + Nip. 3/8"	M. + Inn. M. a valvola 1/2"	647 001 400



COMPONENTI OLEODINAMICI
HYDRAULICS COMPONENTS

MANOMETRI E ACCESSORI
PRESSURE GAUGES & ACCESSORIES

MANOMETRI DIAMETRO CASSA 63 mm



Classe di Precisione 1,6%
Accuracy 1,6%

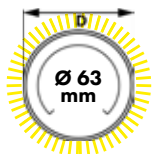

CON GLICERINA
with Glycerine



Campo di Scala (bar/PSI) Scale Range (bar/PSI)		Filetto Thread	A Bagno di Glicerina Cassa INOX Attacco Radiale With Glycerine Stainless Steel Case Bottom Connection	A Bagno di Glicerina Cassa INOX Attacco Posteriore With Glycerine Stainless Steel Case Back Connection	A Bagno di Glicerina Cassa INOX Attacco Flangiato Post. With Glycerine Stainless Steel Case Flanged Back Conn.
da/from	a/to	Inch	Codice / Part. nr.	Codice / Part. nr.	Codice / Part. nr.
-1	0	G 1/4"	620 630 101	621 630 101	622 630 101
-1	1,5	G 1/4"	620 630 102	621 630 102	622 630 102
-1	3	G 1/4"	620 630 103	621 630 103	622 630 103
-1	5	G 1/4"	620 630 105	621 630 105	622 630 105
-1	9	G 1/4"	620 630 109	621 630 109	622 630 109
0	2,5	G 1/4"	620 630 002	621 630 002	622 630 002
0	4	G 1/4"	620 630 004	621 630 004	622 630 004
0	6	G 1/4"	620 630 006	621 630 006	622 630 006
0	10	G 1/4"	620 630 010	621 630 010	622 630 010
0	16	G 1/4"	620 630 016	621 630 016	622 630 016
0	25	G 1/4"	620 630 025	621 630 025	622 630 025
0	40	G 1/4"	620 630 040	621 630 040	622 630 040
0	60	G 1/4"	620 630 060	621 630 060	622 630 060
0	100	G 1/4"	620 630 100	621 630 100	622 630 100
0	160	G 1/4"	620 630 160	621 630 160	622 630 160
0	250	G 1/4"	620 630 250	621 630 250	622 630 250
0	315	G 1/4"	620 630 315	621 630 315	622 630 315
0	400	G 1/4"	620 630 400	621 630 400	622 630 400
0	600	G 1/4"	620 630 600	621 630 600	622 630 600
0	1000	G 1/4"	620 631 000	621 631 000	622 631 000



Staffa Supporto per Attacco Posteriore Plummer for Back Connection
Codice / Part. nr. 615 000 003

A Richiesta / On Request: Certificato di Taratura / Calibration Certificate Personalizzazione Quadrante / Dial Customization	Quantità min. Min Quantity
Codice / Part. nr. 626 000 001	Pz/Pcs 50

● Fornibile in 7 gg lavorativi / Available in 7 working days

MANOMETRI DIAMETRO CASSA 100 mm



Classe di Precisione 1%
Accuracy 1%

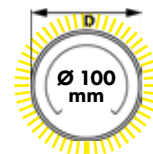

CON GLICERINA
with Glycerine



Campo di Scala (bar/PSI) Scale Range (bar/PSI)		Filetto Thread	A Bagno di Glicerina Cassa INOX Attacco Radiale With Glycerine Stainless Steel Case Bottom Connection	A Bagno di Glicerina Cassa INOX Attacco Posteriore With Glycerine Stainless Steel Case Back Connection	A Bagno di Glicerina Cassa INOX Attacco Flangiato Post. With Glycerine Stainless Steel Case Flanged Back Conn.
da/from	a/to	Inch	Codice / Part. nr.	Codice / Part. nr.	Codice / Part. nr.
-1	0	G 1/2"	620 100 101	621 100 101	622 100 101
-1	3	G 1/2"	620 100 103	621 100 103	622 100 103
0	2,5	G 1/2"	620 100 002	621 100 002	622 100 002
0	4	G 1/2"	620 100 004	621 100 004	622 100 004
0	6	G 1/2"	620 100 006	621 100 006	622 100 006
0	10	G 1/2"	620 100 010	621 100 010	622 100 010
0	16	G 1/2"	620 100 016	621 100 016	622 100 016
0	25	G 1/2"	620 100 025	621 100 025	622 100 025
0	40	G 1/2"	620 100 040	621 100 040	622 100 040
0	60	G 1/2"	620 100 060	621 100 060	622 100 060
0	100	G 1/2"	620 100 100	621 100 100	622 100 100
0	160	G 1/2"	620 100 160	621 100 160	622 100 160
0	250	G 1/2"	620 100 250	621 100 250	622 100 250
0	400	G 1/2"	620 100 400	621 100 400	622 100 400
0	600	G 1/2"	620 100 600	621 100 600	622 100 600
0	1000	G 1/2"	620 101 000	621 101 000	622 101 000



Staffa Supporto per Attacco Posteriore Plummer for Back Connection
Codice / Part. nr. 615 000 004

A Richiesta / On Request: Certificato di Taratura / Calibration Certificate Personalizzazione Quadrante / Dial Customization	Quantità min. Min Quantity
Codice / Part. nr. 626 000 001	Pz/Pcs 50

● Fornibile in 7 gg lavorativi / Available in 7 working days

MANOMETRI ISOMETRICI

CLASSE DI PRECISIONE SEZIONE
Quadrante Bianco 1,6%
Accuracy 1,6%

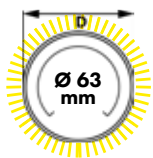

ISOMETRICO
Isometric



Campo di Scala (bar/PSI) Scale Range (bar/PSI)		Filetto Thread	A Bagno di Glicerina Cassa INOX Attacco Radiale With Glycerine Stainless Steel Case Bottom Connection	A Bagno di Glicerina Cassa INOX Attacco Posteriore With Glycerine Stainless Steel Case Back Connection
da/from	a/to	Inch	Codice / Part. nr.	Codice / Part. nr.
5	25	G 1/4"	623 630 001	624 630 001
15	60	G 1/4"	623 630 003	624 630 003

CLASSE DI PRECISIONE SEZIONE
Quadrante Bianco 1,0%
Accuracy 1,6%

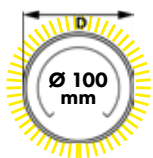

ISOMETRICO
Isometric



Campo di Scala (bar/PSI) Scale Range (bar/PSI)		Filetto Thread	A Bagno di Glicerina Cassa INOX Attacco Radiale With Glycerine Stainless Steel Case Bottom Connection
da/from	a/to	Inch	Codice / Part. nr.
5	25	G 1/2"	625 630 001
15	60	G 1/2"	625 630 003



ESCLUSORI MANOMETRO



Filetto Thread	Eslusore Manometro a Spillo in Linea M.conico/Femmina gir. Gauge Isolator Needle Valves in Line M.BSPT/Female swivel	Eslusore Manometro a Spillo a 90° M.conico/Femmina gir. Gauge Isolator Needle Valves 90° Angle M.BSPT/Female swivel
Inch	Codice / Part. nr.	Codice / Part. nr.
G 1/4"	610 290 014	610 291 014
G 1/2"	610 290 012	610 291 012

ADATTATORI PORTAMANOMETRO



Filetto Thread	Portamanometro Femmina girevole/ Maschio gas cilindrico Swivel Femal Gauges adaptor/BSP Male	Filetto G Thread G	Filetto G1 Thread G1	Portamanometro Femmina girevole/ Maschio cas conico Swivel Femal Gauges adaptor/BSPT Male
Inch	Codice / Part. nr.	Inch	Inch	Codice / Part. nr.
G 1/4"	630 001 004	G 1/4"	G 1/2"	630 001 804
G 1/2"	630 001 008	G 1/2"	G 1/4"	630 001 408

ACCESSORI MANOMETRO



Filetto Thread	Pastiglia in Rame Copper Washer	Diametro Manometro Pressure Gauge Diameter	Calotta di protezione in gomma per Manometri Rubber protection for pressure gauge
Inch	Codice / Part. nr.	Inch	Codice / Part. nr.
G 1/4"	635 001 004	63	637 000 001
G 1/2"	635 001 008	100	637 000 002

MINIPRESE DI PRESSIONE



Gas Cilindrico BSP



Filetto Thread	Minipresa di Pressione Filetto Maschio Gas cil. Cappuccio Plastica Male BSP Check-Coupling Plastic Cup	Minipresa di Pressione Filetto Maschio Gas cil. Cappuccio Metallo Male BSP Check-Coupling Metal Cup
Inch	Codice / Part. nr.	Codice / Part. nr.
G 1/8"	633 001 002	634 001 002
G 1/4"	633 001 004	634 001 004
G 3/8"	633 001 006	634 001 006

Metrico Cil. Metric



Filetto Thread	Minipresa di Pressione Fil. Maschio Metrico cil. Cappuccio Plastica Male Metric Check-Coupling Plastic Cup	Minipresa di Pressione Fil. Maschio Metrico cil. Cappuccio Metallo Male Metric Check-Coupling Metal Cup
mm	Codice / Part. nr.	Codice / Part. nr.
M 10x1,25	633 001 101	
M 12x1,5	633 001 122	634 001 122
M 14x1,5	633 001 142	634 001 142
M 16x1,5	633 001 162	634 001 162

Gas Cilindrico BSP



Filetto Thread	Minipresa di Pressione Filetto Femmina Gas cil. Cappuccio Plastica Female BSP Check-Coupling Plastic Cup
Inch	Codice / Part. nr.
G 1/4"	633 101 004

VALIGETTE CONTROLLO PRESSIONI



CONTENUTO

- n° 1 Valigetta in Plastica;
- n° 2 Manometri Glicerina Ø 63 (scala 0-250 / 0-600);
- n° 1 Microtubo raccordato Femmina avvitabile M16x2 + Femmina Portamanometro da 1/4" Lunghezza mm 2000.

CONTENT

- n° 1 Plastic Box;
- n° 2 Glycerine-filled Gauge Ø 63 (0-250/0-600 range);
- n° 1 Microhose Nut Connection M16x2 + Pressure Gauge Female Fitting 1/4" Length mm2000.



Dimensioni Dimensions	Valigetta in Plastica per controllo pressioni Modello Piccolo Pressure Check Plastic Test Box Small Size
mm	Codice / Part. nr.
240 x 200 x 40	636 000 001

CONTENUTO

- n° 1 Valigetta in Plastica;
- n° 2 Manometri Glicerina Ø 63 (scala 0-250 / 0/600);
- n° 2 Miniprese M16x2 x 1/4"
- n° 1 Microtubo raccordato Femmina avvitabile M16x2 + Femmina avvitabile M16x2 Lunghezza mm 2000;
- n° 2 Portamanometri da 1/4" con passaparete Maschio M16x2;
- n° 1 Portamanometri da 1/4" con passaparete Femmina M16x2;
- n° 1 Riduzione Femmina M10x1 x Maschio 3/8";
- n° 1 Riduzione Femmina M10x1 x Maschio 1/2";
- n° 1 Minipresa M16x2 x M8x1.

CONTENT

- n° 1 Plastic Box;
- n° 2 Glycerine-filled Gauge Ø 63 (0-250/0-600 range);
- n° 2 Test Points M16x2 x 1/4";
- n° 1 Microhose Nut Connection M16x2 + Nut Connection M16x2 Length mm2000;
- n° 2 Pressure Gauge 1/4" Bulkhead Male M16x2;
- n° 1 Pressure Gauge 1/4" Bulkhead Female M16x2;
- n° 1 Reducer Female M10x1 x Male 3/8";
- n° 1 Reducer Female M10x1 x Male 1/2";
- n° 1 Test Point M16x2 x M8x1.



Dimensioni Dimensions	Valigetta in Plastica per controllo pressioni Modello Grande Pressure Check Plastic Test Box Large Size
mm	Codice / Part. nr.
390 x 200 x 80	636 000 002



IMPIEGO

Tubo per alta pressione indicato per fluidi idraulici a base minerale, sintetica o acquosa in mini-oleodinamica: collegamento a misuratori di pressione, prese di pressione e trasduttori. Sistemi idraulici per azionamento cappotta autoveicoli. Sistemi frenanti per biciclette. Idoneo anche per trasferimento di gas.

- Temperatura: da -40 °C a +100 °C, limitata a +70 °C per aria e fluidi a base acquosa.

STRUTTURA

- Sottostrato: Elastomero poliester.
- Rinforzi: **una treccia in fibra aramidica.**
- Copertura: Poliuretano anti-grip, nero, microforata.
- Pressione di esercizio: rapporto di sicurezza 1:3.
- Valore max. di vuoto: -0,93 bar; 700 mm Hg.

APPLICATION

High pressure hose suitable for petroleum synthetic or water based hydraulic fluids in hydraulic mini systems: connections to pressure gauges or pressure switches and transducers. Hydraulic roof opening systems for convertible cars. Bicycle braking systems. Also suitable for gas transfer.

- Temperature range: -40 °C to +100 °C: limited to +70 °C for air and water based fluids.

CONSTRUCTION

- Tube: Polyester elastomer.
- Reinforcement: **one aramidic fiber braid.**
- Cover: Anti-grip polyurethane, black, pinpricked.
- Working pressure: safety ratio 1:3.
- Vacuum rating: -13,5 psi; 27,5 inch Hg.



Codice Part Number	Diametro Interno Inside Diameter			Ø Esterno O.D.	Pr. Esercizio Max WP	Pr. Scoppio Burst Pr.	Raggio Curv. Bend Radius	Peso Weight	Boccola Ferrule	Lunghezza Length
	DN	Inch	mm							
631 001 004	2	5/64"	2	5	630	1900	20	20	631 100 215	
631 001 008	4	5/32"	4	8	630	1900	40	45		

In neretto idoneo ai raccordi delle pagine seguenti/ bold used for fittings on the following pages



Tubo Hose		Conf. Box	Boccola Microtubo Microhose Ferrule
DN	Inch	pz./pcs	Codice / Part. nr.
2	5/64"	5	631 100 215

RACCORDI FEMMINA AVVITABILE



Tubo Hose		Filetto Thread	Conf. Box	Femmina Avvitabile Nut Connection	Femmina 90° Avvitabile 90° Nut Connection
DN	Inch	pz./pcs	pz./pcs	Codice / Part. nr.	Codice / Part. nr.
2	5/64"	M 16x1,5	5	631 100 162	
2	5/64"	M 16x2	5	631 100 163	631 110 163

RACCORDI PORTAMANOMETRO GAS CILINDRICO



Tubo Hose		Filetto Thread	Conf. Box	Femmina Avvitabile Nut Connection	Femmina 90° Avvitabile 90° Nut Connection
DN	Inch	pz./pcs	pz./pcs	Codice / Part. nr.	Codice / Part. nr.
2	5/64"	G 1/4"-19	5	631 100 304	631 110 404
2	5/64"	G 1/2"-14	5	631 100 308	

● Fornibile in 7 gg lavorativi / Available in 7 working days

RACCORDI PORTAMANOMETRO NPTF



Tubo Hose		Filetto Thread	Conf. Box	Femmina Portamanometro NPTF NPTF Pressure Gauge Female	
DN	Inch	Inch	pz./pcs	Codice / Part. nr.	
2	5/64"	G 1/4"-18	5	●	631 100 404

RACCORDI PORTAMANOMETRO METRICO



Tubo Hose		Filetto Thread	Conf. Box	Femmina Portamanometro NPTF NPTF Pressure Gauge Female	
DN	Inch	mm	pz./pcs	Codice / Part. nr.	
2	5/64"	M 20x1,5	5	●	631 101 202

RACCORDI GAS CILINDRICO SV. 60°



Tubo Hose		Filetto Thread	Conf. Box	Femmina Girevole Gas cilindrica sv. 60° BSP 60° Swivel Female	Femmina Girevole 90° Gas cilindrica sv. 60° 90° BSP 60° Swivel Female	Maschio Fisso Gas cilindrico BSP Fixed Male
DN	Inch	Inch	pz./pcs	Codice / Part. nr.	Codice / Part. nr.	Codice / Part. nr.
2	5/64"	G 1/8"-28	5	●	631 100 002	● 631 100 102
2	5/64"	G 1/4"-19	5	●	631 100 004	● 631 110 104

RACCORDI MASCHIO NPTF



Tubo Hose		Filetto Thread	Conf. Box	Maschio Fisso NPT NPT Fixed Male	
DN	Inch	Inch	pz./pcs	Codice / Part. nr.	
2	5/64"	G 1/8"-27	5	●	631 100 202
2	5/64"	G 1/4"-18	5	●	631 100 204

RACCORDI FEMMINA METRICA SV. 60°



Tubo Hose		Filetto Thread	Conf. Box	Femmina Girevole Metrica cilindrica sv. 60° Metric 60° Swivel Female	
DN	Inch	mm	pz./pcs	Codice / Part. nr.	
2	5/64"	M 14x1,5	5	●	631 100 142

RACCORDI ESTREMITÀ TUBOLARE LISCIA



Tubo Hose		Ø Codolo Pipe Ø	Conf. Box	Estremità Tubolare Diritta Straight Standpipe		Estremità Tubolare 90° 90° Standpipe
DN	Inch	mm	pz./pcs	Codice / Part. nr.	Codice / Part. nr.	
2	5/64"	4 L	5	●	631 100 040	● 631 100 140
2	5/64"	6L/S	5	●	631 100 060	● 631 100 160
2	5/64"	8L/S	5	●	631 100 080	● 631 100 180

● Fornibile in 7 gg lavorativi / Available in 7 working days

RACCORDI FEMMINA METRICA SV. 24°



**SENZA O-RING
WITHOUT O-RING**



Tubo Hose		Serie Series		Filetto Thread		Conf. Box		Femmina Metrica sv. 24° Preassembled 24° Metric Female	Femmina 90° Metrica sv. 24° Preassembled 24° Metric 90° Female
DN	Inch	mm	mm	Ø	pz./pcs			Codice / Part. nr.	Codice / Part. nr.
2	5/64"	L	M 12x1,5	6L	5	●		631 100 612	631 101 612
2	5/64"	L	M 14x1,5	8L	5	●		631 100 814	631 101 814
2	5/64"	S	M 14x1,5	6S	5	●		631 100 614	631 101 614
2	5/64"	S	M 16x1,5	8S	5	●		631 100 816	631 101 816

**SENZA O-RING
WITHOUT O-RING**



Tubo Hose		Serie Series		Filetto Thread		Conf. Box		Femmina Metrica sv. 24° Preassembled 24° Metric Female with O-ring	Femmina 90° Metrica sv. 24° Preassembled 24° Metric 90° Female with O-ring
DN	Inch	mm	mm	Ø	pz./pcs			Codice / Part. nr.	Codice / Part. nr.
2	5/64"	LL	M 10x1	6LL	5	●		631 110 610	
2	5/64"	L	M 12x1,5	6L	5	●		631 110 612	631 120 612
2	5/64"	L	M 14x1,5	8L	5	●		631 110 814	631 120 814
2	5/64"	L	M 16x1,5	10L	5	●		631 111 016	631 121 016
2	5/64"	S	M 14x1,5	6S	5	●		631 110 614	631 120 614
2	5/64"	S	M 16x1,5	8S	5	●		631 110 816	631 120 816
2	5/64"	S	M 18x1,5	10S	5	●		631 111 018	631 121 018

RACCORDI A BAIONETTA



Tubo Hose		Ø Attacco Connection Ø	Conf. Box	Innesto a Baionetta Plug-in Connection
DN	Inch	mm	pz./pcs	Codice / Part. nr.
2	5/64"	3,3	5	631 100 033

RACCORDI AD OCCHIO GAS



**OCCHIO PER VITE GAS
BSP BOLT BANJO**



Tubo Hose		Ø Occhio Banjo Ø	Conf. Box	Occhio Dritto Gas BSP Straight Banjo	Occhio 90° Gas BSP 90° Banjo
DN	Inch	Inch	pz./pcs	Codice / Part. nr.	Codice / Part. nr.
2	5/64"	G 1/8"	5	631 130 002	631 131 002

Filetto Thread	Conf. Box	Vite Forata Gas BSP Bolt
Inch	pz./pcs	Codice / Part. nr.
G 1/8"-28	5	631 132 002

RACCORDI AD OCCHIO METRICO

**OCCHIO PER VITE METRICA
METRIC BOLT BANJO**



Tubo Hose		Ø Occhio Banjo Ø	Conf. Box	Occhio Dritto Metrico Metric Straight Banjo	Occhio 90° Metrico Metric 90° Banjo
DN	Inch	mm	pz./pcs	Codice / Part. nr.	Codice / Part. nr.
2	5/64"	M 8	5	631 130 080	631 131 080
2	5/64"	M 10	5	631 130 100	631 131 100

Filetto Thread	Conf. Box	Vite Forata Metrica Metric Bolt
mm	pz./pcs	Codice / Part. nr.
M 8x1	5	631 132 080
M 10x1	5	631 132 100

● Fornibile in 7 gg lavorativi / Available in 7 working days

RACCORDI FEMMINA JIC SV. 74°



Tubo Hose		Filetto Thread	Conf. Box	Femmina Girevole Jic sv. 74° Jic 74° Swivel Female	
DN	Inch	Inch	pz./pcs		Codice / Part. nr.
2	5/64"	7/16"-20 UNF	5	●	631 133 004
2	5/64"	1/2"-20 UNF	5	●	631 133 005

RACCORDI FEMMINA ORFS



Tubo Hose		Filetto Thread	Conf. Box	Femmina Girevole ORFS ORFS Swivel Female	
DN	Inch	Inch	pz./pcs		Codice / Part. nr.
2	5/64"	11/16"-16 UN	5	●	631 131 116

CAPPUCCI PARAPOLVERE



Tipo Raccordo Fitting Type		Conf. Box	Cappuccio Parapolvere Dust Protection Cap	
mm		pz./pcs		Codice / Part. nr.
Avvitabile / Nut Connection		5	●	631 134 163
Baionetta / Plug-in Connection		5	●	631 134 033



FRENI & ARIA CONDIZIONATA
BRAKE & CONDITIONING AIR

TUBO E RACCORDI PER SISTEMI FRENANTI
BRAKE SYSTEMS HOSE & FITTINGS

CONSIGLI PER IL MONTAGGIO ASSEMBLING ADVISE

PREMESSA

Gli impianti frenanti sono molto importanti per la sicurezza del mezzo su cui sono montati: **una loro avaria può avere conseguenze gravissime per persone e cose.**

Tutti gli utilizzatori dei prodotti illustrati, prima di impiegarli nella manutenzione o costruzione di impianti frenanti, dovranno necessariamente accertarsi che essi rispondano alle esigenze tecniche della sua applicazione.

La **HSR Italia** non costruisce i prodotti elencati in questo catalogo e **non si assume altra responsabilità se non quella della conformità dei prodotti alle loro dimensioni nominali (compatibilità dimensionale solamente).**

CONSIGLI PER IL MONTAGGIO

- In caso di interventi su impianti frenanti, seguire sempre le istruzioni del costruttore dei mezzi.
- Gli interventi sulle tubazioni degli impianti frenanti, vanno eseguiti solo da tecnici specializzati.
- Non rabboccare con liquido nuovo gli impianti di frenatura idraulici e sostituire sempre tutto il liquido, usando il tipo consigliato dal costruttore.
- Assicurarsi che il tubo venga tagliato in maniera netta perpendicolarmente.
- Assicurarsi che il tubo venga introdotto fino in fondo al raccordo.
- Procedere all'assemblaggio fra tubo e raccordo, tramite pinzatura, con appositi morsetti, costruiti specificamente per la pinzatura dei raccordi freno, assicurandosi che il nonio sia ben regolato consentendo così di ottenere la pinzatura ottimale (vedi tabella pagina seguente). Ricordiamo i diametri consigliati sono **INDICATIVI** e per ottenere un risultato certo bisogna provare il tubo assemblato sul banco prova.
- Verificare che non vi siano strozzature, soffiando all'interno del tubo dell'aria.
- Evitare assolutamente di far compiere al tubo curve troppo strette o torsioni o tensionamenti; non sollecitare con cariche esterne i raccordi.
- Controllare che quanto detto al punto precedente, valga in ogni possibile configurazione della macchina.
- Se nelle connessioni sono usate guarnizioni, sostituirle con delle nuove in occasione di ogni montaggio; fare la stessa cosa con le viti forate se presenti.
- Verificare attentamente ogni singolo tubo raccordato prima di procedere all'installazione dell'applicazione sul mezzo, accertarsi scrupolosamente che non vi siano strozzature o intasamenti.
- Non applicare una coppia di serraggio eccessiva ai raccordi montati sui flessibili e alle viti forate; di solito una coppia di serraggio di 10 Nm è più che sufficiente per i raccordi per tubi da 1/8" a 3/16".
- Eeguire un accurato spurgo di tutta l'aria presente nel circuito freni idraulici, prima di rimetterlo in funzione.
- A richiesta, possiamo fornire un apposito banco prova per il collaudo.

INTRODUCTION

The efficiency of brake systems are mostly very important for the safety of the vehicle: **a failure can damage people and effects.**

Each user of the illustrated products, before using, must be sure the products are compatible with its application.

The HSR Italy does not make the products in this catalogue and **we cannot assume any responsibility, just for the correct sizes (dimensional compatibility only).**

ASSEMBLING ADVISE

- Always follow instruction and accordings of the vehicles constructor about brake systems.
- The intervention on a pipeline of the brake system must be done by a specialized technical.
- Do not top up with liquid a new hydraulic refraining system and always replace completely the liquid advised by the constructor.
- Make sure that the hose is cut sharply at right angles.
- Make sure that the hose is inserted to the end of the fitting.
- Proceed to the assembly between hose and fitting, using stapling, with special dies, built specifically for stapling of brake fittings, making sure that the vernier is in the correct position thus providing optimal stapling (see table next page). We remember that the recommended diameters are **APPROXIMATE** and to obtain a certain result must try the hose assembly on the test bench.
- Verify that there are no bottlenecks, by blowing air into the hose.
- Avoid extreme bending and twisting of the hoses ; do not stress with heavy overload.
- Check if everything said by the previous point will be followed in any case of configuration of the machine.
- If the connections contain washers, replace them with new ones any time of new installation the same thing for drilled screws.
- Check with attention each single connected hose before the assembling. Control if there aren't any throttlings or obstructions.
- Do not fix an extreme tightening torque on the fittings assembled on flexible and the drilled screws ; normally a tightening torque of 10 Nm is enough for hoses fittings from 1/8" to 3/16".
- A complete bleeding is required before using the hydraulic circuit.
- On request, we can provide a test bench for testing.

CONSIGLI PER L'ASSEMBLAGGIO SWAGING ADVISE



Codice Part Number	Diametro Interno Inside Diameter			Ø Esterno O.D. mm	Pr. Esercizio Max WP bar	Pr. Scoppio Burst Pr. bar	Raggio Curv. Bend Radius mm	Lunghezza Lenght mt
	DN	Inch	mm					
100 120 180	3	1/8"	3,2	10,5	200	600	102	± 10,2

RILEVAMENTO LUNGHEZZA

Le istruzioni illustrate sono state realizzate per eliminare confusioni ed insicurezze sulla corretta lunghezza del tubo da rilevare per l'assemblaggio.

Quando si deve realizzare un tubo assemblato è opportuno essere sicuri che le istruzioni qui riportate siano eseguite in maniera corretta.

Tutte le misurazioni devono essere rilevate dal centro della sede del primo raccordo al centro della sede del secondo raccordo.

Queste regole si applicano in tutti i casi se non vengono fornite istruzioni **CHIARE** sull'ordine di acquisto o su un disegno fornitoci.

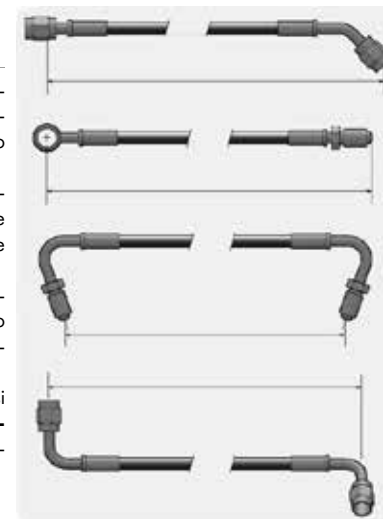

CORRECT LENGTH

The illustrated instructions are designed to eliminate confusion and ensure that correct hose lengths are supplied for assembly.

When ordering hose assemblies please make sure that the illustrated instruction are accurately followed.

All measurements are taken from the centre of seat of first fitting to the centre of seat of second seat. This will apply in all cases unless **CLEAR** instructions are given on purchase order or a drawing supplied.

ORIENTAMENTO CORRETO

Per l'orientamento del tubo attenersi allo schema riportato, altre indicazioni di orientamento diverse devono essere comunicate chiaramente con l'invio di disegno scritto.

In assenza di precisa comunicazione, il tubo dovrà essere prodotto con un orientamento di 0 gradi.

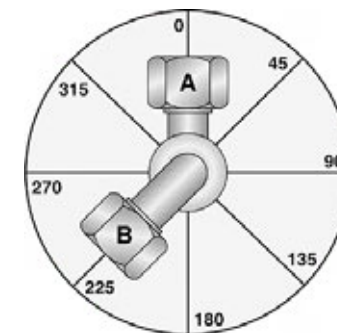

CORRECT ORIENTATION

To follow the orientation of the hose to the diagram, other indications of different orientation must be communicated clearly with the drawing sending written.

In the absence of precise communication the hose it will be produced with an orientation of 0 degrees.

TUBO IN GOMMA SAE J 1401



IMPIEGO

Tubo in gomma idoneo per **sistemi frenanti** di mezzi mobili stradali con fluidi frenanti non minerali.

- Temperatura: da -45 °C a +100 °C

STRUTTURA

- Sottostrato: gomma resistente ai **fluidi per freni**.
- Rinforzi: **treccia tessile rinforzata**.
- Copertura: gomma sintetica resistente all'abrasione, all'acqua, alla salsedine, all'ozono ed al calore.
- Normativa di riferimento: **SAE J 1401**

APPLICATION

High pressure hose suitable for conveying non petroleum base **brake fluids**.

- Temperature range: -45 °C to +100 °C

CONSTRUCTION

- Tube: **brake fluid** resitant rubber.
- Reinforcement: **textile braid**.
- Cover: abrasion, weather, hugh temperature resistant rubber and saltness.
- According to: **SAE J 1401**



Codice Part Number	Diametro Interno Inside Diameter			Ø Esterno O.D.	Pr. Esercizio Max WP	Pr. Scoppio Burst Pr.	Raggio Curv. Bend Radius	Peso Weight	Lunghezza Lenght
	DN	Inch	mm						
100 120 180	3	1/8"	3,2	10,5	200	600	102	0,091	> 10

GIUNZIONE TUBO-TUBO



Tubo Hose		Tubo Hose		Giunzione Tubo/Tubo Hose/Hose Connection
DN	Inch	DN	Inch	Codice / Part. nr.
2	5/64"	2	5/64"	190 201 001

RACCORDI MASCHIO



RACCORDI FRENO MONOPEZZO
MONO PIECE BRAKE FITTINGS

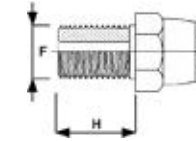

Tubo Hose		Filetto Thread	H	CH	Maschio Tutto Filetto Testa Piana All Thread Male Flat Head
DN	Inch	Inch	mm	mm	Codice / Part. nr.
3	1/8"	M 10x1	10	15	200 002 001
3	1/8"	M 10x1	12	17	200 002 002
3	1/8"	M 10x1,25	12,5	17	200 002 003
3	1/8"	G 3/8"-24	12,5	15	200 002 004
3	1/8"	G 7/16"-20	12,2	17	200 002 114

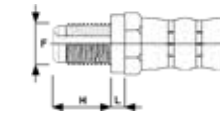

Tubo Hose		Filetto Thread	H	L	CH	Maschio Tutto Filetto Testa Piana All Thread Male Flat Head
DN	Inch	Inch	mm	mm	mm	Codice / Part. nr.
3	1/8"	M 10x1	12	4	16	200 002 005
3	1/8"	M 10x1,25	15	1	15	200 002 006
3	1/8"	G 3/8"-24	13	2	17	200 002 007
3	1/8"	G 3/8"-24	12,25	6	17	200 002 008

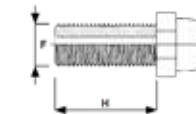

Tubo Hose		Filetto Thread	H	CH	Maschio Tutto Filetto Testa Svasata All Thread Male Cone Head
DN	Inch	Inch	mm	mm	Codice / Part. nr.
3	1/8"	M 10x1	21	16	200 002 009

RACCORDI MASCHIO



RACCORDI FRENO MONOPEZZO
MONO PIECE BRAKE FITTINGS

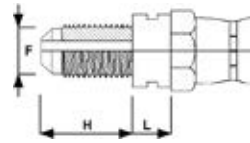

Tubo Hose		Filetto Thread	H	L	CH	Maschio Sede Seeger Testa Convessa Seat Seeger Male Convex Head
DN	Inch	mm	mm	mm	mm	Codice / Part. nr.
3	1/8"	M 10x1	15	8,3	17	200 002 010

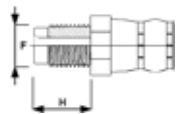

Tubo Hose		Filetto Thread	H	CH	Maschio Filetto Parziale Testa Svasata Partial Thread Male Cone Head
DN	Inch	Inch	mm	mm	Codice / Part. nr.
3	1/8"	M 10x1	12	17	200 002 011
3	1/8"	M 10x1	14	14	200 002 012
3	1/8"	M 10x1	16,8	17	200 002 013
3	1/8"	M 10x1,25	13	15	200 002 014
3	1/8"	M 12x1	16,3	15	200 002 214

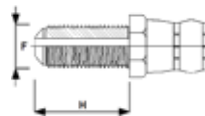

Tubo Hose		Filetto Thread	H	CH	Maschio Tutto Filetto Testa Convessa All Thread Male Convex Head
DN	Inch	Inch	mm	mm	Codice / Part. nr.
3	1/8"	M 10x1	22,7	16	200 002 015
3	1/8"	M 10x1	23,5	17	200 002 016
3	1/8"	M 10x1	28	NO	200 002 017
3	1/8"	M 10x1,25	17,3	15	200 002 018
3	1/8"	G 3/8"-24	23	15	200 002 019
3	1/8"	G 3/8"-24	25	15	200 002 020
3	1/8"	G 7/16"-20	29,7	17	200 002 115

RACCORDI MASCHIO



RACCORDI FRENO MONOPEZZO
MONO PIECE BRAKE FITTINGS

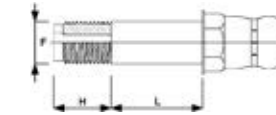

Tubo Hose		Filetto Thread	H	L	CH	Maschio Filetto Parziale Versione Lunga Partial Thread Male Long Version
DN	Inch	mm	mm	mm	mm	Codice / Part. nr.
3	1/8"	M 10x1	12	14,5	14	200 002 021
3	1/8"	M 10x1	13,2	20	14	200 002 022
3	1/8"	M 10x1	13,2	24,9	14	200 002 023
3	1/8"	M 10x1	15,5	35	14	200 002 024

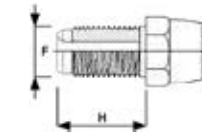

Tubo Hose		Filetto Thread	H	CH	Maschio Tutto Filetto Testa Svasata All Thread Male Cone Head
DN	Inch	mm	mm	mm	Codice / Part. nr.
3	1/8"	M 10x1	15,3	14	200 002 025
3	1/8"	M 10x1	19,3	14	200 002 026

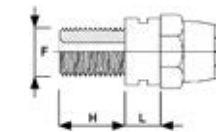

Tubo Hose		Filetto Thread	H	CH	Maschio Tutto Filetto Testa Piana All Thread Male Flat Head
DN	Inch	mm	mm	mm	Codice / Part. nr.
3	1/8"	M 10x1	13,6	19	200 002 028
3	1/8"	M 10x1	14,3	17	200 002 027

RACCORDI MASCHIO GIREVOLE



RACCORDI FRENO MONOPEZZO
MONO PIECE BRAKE FITTINGS

SVASATO
FLARE

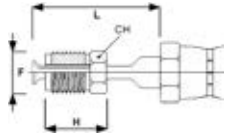

Tubo Hose		Filetto Thread	H	L	CH	Maschio Girevole Svasato Swivel Male Flare
DN	Inch	mm	mm	mm	mm	Codice / Part. nr.
3	1/8"	M 10x1	18,1	34,5	10	200 004 029
3	1/8"	M 10x1,25	17,1	34,5	10	200 004 030
3	1/8"	M 12x1	23	65	12	200 004 031
3	1/8"	G 3/8"-24	18	39,7	10	200 004 032

SVASATO
FLARE

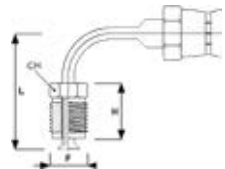

Tubo Hose		Filetto Thread	H	L	CH	Maschio 90° Girevole Svasato 90° Swivel Male Flare
DN	Inch	mm	mm	mm	mm	Codice / Part. nr.
3	1/8"	M 10x1	19	39,5	10	200 004 033
3	1/8"	M 10x1,25	17,1	39,5	10	200 004 034
3	1/8"	M 12x1	21,8	42	12	200 004 035
3	1/8"	G 3/8"-24	18	39,5	10	200 004 037

RACCORDI MASCHIO GIREVOLE



RACCORDI FRENO MONOPEZZO
MONO PIECE BRAKE FITTINGS

BOMBATO
BUBBLE FLARE

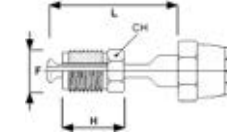

Tubo Hose		Filetto Thread	H	L	CH	Maschio Filetto Parziale Versione Lunga Partial Thread Male Long Version
DN	Inch	mm	mm	mm	mm	Codice / Part. nr.
3	1/8"	M 10x1	17	38	14	200 004 038
3	1/8"	M 10x1,25	17,1	40	10	200 004 039
3	1/8"	M 12x1	21,8	43,5	12	200 004 040
3	1/8"	G 3/8"-24	18	39,7	10	200 004 042

BOMBATO
BUBBLE FLARE

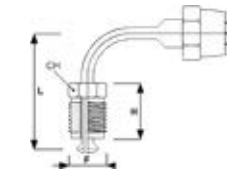

Tubo Hose		Filetto Thread	H	L	CH	Maschio 90° Girevole Bombato 90° Swivel Male Bubble Flare
DN	Inch	mm	mm	mm	mm	Codice / Part. nr.
3	1/8"	M 10x1	17	38	14	200 004 043
3	1/8"	M 10x1,25	17,1	40	10	200 004 044
3	1/8"	M 12x1	21,8	43,5	12	200 004 045
3	1/8"	G 3/8"-24	18	39,7	10	200 004 047

RACCORDI FEMMINA FISSA

RACCORDI FRENO MONOPEZZO
MONO PIECE BRAKE FITTINGS

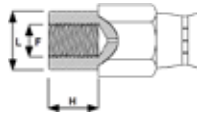

Tubo Hose	Filetto Thread	H	L	CH	Femmina Fissa Interno Concavo Fixed Female Concave Internal	Note	
DN	Inch	mm	mm	mm	Codice / Part. nr.		
3	1/8"	M 10x1	11,2	13,5	14	210 002 001	
3	1/8"	M 10x1	11,2	16	17	210 002 002	
3	1/8"	M 10x1	11,4	16	17	210 002 003	1 lato piano
3	1/8"	M 10x1	11,4	16	17	210 002 004	2 lati piani
3	1/8"	M 12x1	11,2	16	17	210 002 005	

CON
POSIZIONATORI
WITH POSITIONING



Tubo Hose	Filetto Thread	H	Femmina Fissa Interno Concavo Fixed Female Concave Internal	Note
DN	Inch	mm	Codice / Part. nr.	
3	1/8"	M 10x1	210 002 006	2 posizionatori destri - 2 lati piani - incavo
3	1/8"	M 10x1	210 002 007	2 posizionatori sinistri - 2 lati piani - incavo
3	1/8"	M 10x1	210 002 008	2 posizionatori centrali - 2 lati piani
3	1/8"	M 10x1	210 002 009	2 posizionatori - sede seeger - 2 lati piani
3	1/8"	M 10x1	210 002 010	2 posizionatori lunghi - 2 lati piani
3	1/8"	M 10x1	210 002 011	4 posizionatori - 4 lati piani

TESTA ZIGRINATA
KNURLED HEAD

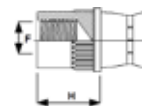

Tubo Hose	Filetto Thread	H	Femmina Fissa Interno Concavo Fixed Female Concave Internal	Note
DN	Inch	mm	Codice / Part. nr.	
3	1/8"	M 10x1	210 002 012	
3	1/8"	M 10x1	210 002 013	1 posiziatore - 1 lato piano
3	1/8"	M 10x1	210 002 014	1 posiz. - 1 lato piano - zigrinatura parziale
3	1/8"	M 10x1	210 002 015	zigrinatura con sede seeger

RACCORDI FEMMINA CON FERMO

RACCORDI FRENO MONOPEZZO
MONO PIECE BRAKE FITTINGS

INTERNO CONCAVO
CONCAVE INTERNAL

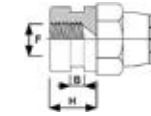

Tubo Hose	Filetto Thread	H	B	CH	Femmina con Fermo Interno Concavo Circlip Groove Female Concave Internal	Note	
DN	Inch	mm	mm	mm	Codice / Part. nr.		
3	1/8"	M 8x1,25	9,2	3	17	210 002 016	
3	1/8"	M 10x1	9	3,2	17	210 002 017	
3	1/8"	M 10x1	11	3,2	17	210 002 018	
3	1/8"	M 10x1	11,2	3,2	17	210 002 019	
3	1/8"	M 10x1	16,4	3,2	17	210 002 020	
3	1/8"	M 10x1	18,5	3,2	19	210 002 021	
3	1/8"	M 10x1	11,3	1,65	17	210 002 022	1 posiziatore - 1 lato piano
3	1/8"	M 10x1	11,4	1,65	17	210 002 023	1 posiziatore - 2 lati piani asimmetrici
3	1/8"	M 10x1	18,3	2,5	19	210 002 024	1 lato piano
3	1/8"	M 10x1,25	18,8	2,9	17	210 002 025	2 lati piani

INTERNO CONCAVO
CONCAVE INTERNAL

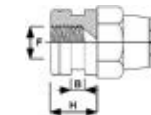

Tubo Hose	Filetto Thread	H	B	Femmina con Fermo Interno Concavo Circlip Groove Female Concave Internal	Note	
DN	Inch	mm	mm	Codice / Part. nr.		
3	1/8"	M 10x1	11	2,5	210 002 026	2 posizionatori

INTERNO CONCAVO
CONCAVE INTERNAL

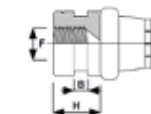

Tubo Hose	Filetto Thread	H	B	Femmina con Fermo Interno Concavo Circlip Groove Female Concave Internal	Note	
DN	Inch	mm	mm	Codice / Part. nr.		
3	1/8"	M 10x1	11	3,2	210 002 027	2 lati piani

RACCORDI FEMMINA CON FERMO

RACCORDI FRENO MONOPEZZO
MONO PIECE BRAKE FITTINGS

INTERNO CONCAVO
CONCAVE INTERNAL

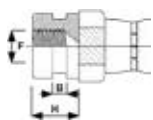

Tubo Hose	Filetto Thread	H	B	Femmina con Fermo Interno Concavo Circlip Groove Female Concave Internal	Note	
DN	Inch	mm	mm	Codice / Part. nr.		
3	1/8"	M 10x1	11	3,3	210 002 028	1 lato piano con posizionale

INTERNO CONCAVO
CONCAVE INTERNAL

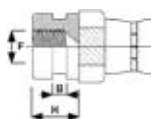

Tubo Hose	Filetto Thread	H	B	Femmina con Fermo Interno Concavo Circlip Groove Female Concave Internal	Note	
DN	Inch	mm	mm	mm	Codice / Part. nr.	
3	1/8"	M 10x1	11,2	2	210 002 029	2 posizionatori - 2 lati piani

INTERNO CONCAVO
CONCAVE INTERNAL

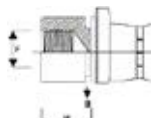

Tubo Hose	Filetto Thread	H	B	Femmina con Fermo Interno Concavo Circlip Groove Female Concave Internal	Note	
DN	Inch	mm	mm	mm	Codice / Part. nr.	
3	1/8"	M 10x1	11	3,4	210 002 030	1 posizionale - 2 lati piani

INTERNO CONCAVO
CONCAVE INTERNAL

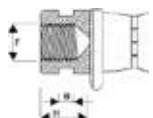

Tubo Hose	Filetto Thread	H	B	Femmina con Fermo Interno Concavo Circlip Groove Female Concave Internal	Note	
DN	Inch	mm	mm	mm	Codice / Part. nr.	
3	1/8"	M 10x1	13,2	3	210 002 031	1 lato piano

RACCORDI FEMMINA CON FERMO

RACCORDI FRENO MONOPEZZO
MONO PIECE BRAKE FITTINGS

INTERNO CONCAVO
CONCAVE INTERNAL

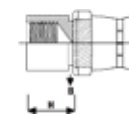

Tubo Hose	Filetto Thread	H	B	Femmina con Fermo Interno Concavo Circlip Groove Female Concave Internal	Note	
DN	Inch	mm	mm	mm	Codice / Part. nr.	
3	1/8"	M 10x1	13,3	2	210 002 032	2 lati piani

INTERNO CONCAVO
CONCAVE INTERNAL

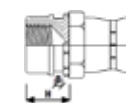

Tubo Hose	Filetto Thread	H	B	Femmina con Fermo Interno Concavo Circlip Groove Female Concave Internal	Note	
DN	Inch	mm	mm	mm	Codice / Part. nr.	
3	1/8"	M 10x1	11,3	2,8	210 002 033	1 anello posizionale - 2 lati piani

INTERNO CONCAVO
CONCAVE INTERNAL



Tubo Hose	Filetto Thread	H	B	Femmina con Fermo Interno Concavo Circlip Groove Female Concave Internal	Note	
DN	Inch	mm	mm	mm	Codice / Part. nr.	
3	1/8"	M 10x1	11,2	2	210 002 034	2 posizionatori - 2 lati piani

INTERNO CONCAVO
CONCAVE INTERNAL

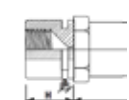

Tubo Hose	Filetto Thread	H	B	Femmina con Fermo Interno Concavo Circlip Groove Female Concave Internal	Note	
DN	Inch	mm	mm	mm	Codice / Part. nr.	
3	1/8"	M 10x1	11,2	49,8	210 002 035	2 posizionatori - 2 lati piani

RACCORDI FEMMINA CON FERMO

RACCORDI FRENO MONOPEZZO
MONO PIECE BRAKE FITTINGS

INTERNO CONCAVO
CONCAVE INTERNAL



Tubo Hose	Filetto Thread	H	Femmina con Fermo Interno Concavo Circlip Groove Female Concave Internal		Note
DN	Inch	mm	mm	Codice / Part. nr.	
3	1/8"	M 10x1	9,8	210 002 036	aletta laterale

INTERNO CONVESSO
CONVEX CONE

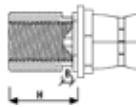

Tubo Hose	Filetto Thread	H	B	CH	Femmina con Fermo Interno Convesso Circlip Groove Female Convex Cone	Note
DN	Inch	mm	mm	mm	Codice / Part. nr.	
3	1/8"	M 10x1	9,3	3,2	210 002 037	con anello
3	1/8"	M 10x1	16,5	2,5	210 002 038	con anello
3	1/8"	M 10x1	13,6	1,7	210 002 039	con anello

INTERNO CONVESSO
CONVEX CONE

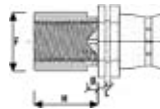

Tubo Hose	Filetto Thread	H	B	L	CH	Femmina con Fermo Interno Convesso Circlip Groove Female Convex Cone	Note
DN	Inch	mm	mm	mm	mm	Codice / Part. nr.	
3	1/8"	M 10x1	16	1,8	1,6	210 002 040	
3	1/8"	M 10x1	16	1,8	1,3	210 002 041	2 lati piani

INTERNO CONVESSO
CONVEX CONE



Tubo Hose	Filetto Thread	H	B	CH	Femmina con Fermo Interno Convesso Circlip Groove Female Convex Cone	Note
DN	Inch	mm	mm	mm	Codice / Part. nr.	
3	1/8"	M 10x1	9,6	3,2	210 002 042	lato fresato
3	1/8"	M 10x1	9,6	3,2	210 002 043	

RACCORDI FEMMINA CON FERMO

RACCORDI FRENO MONOPEZZO
MONO PIECE BRAKE FITTINGS

INTERNO CONVESSO
CONVEX CONE

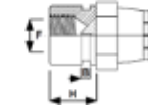

Tubo Hose	Filetto Thread	H	B	CH	Testa Head	Femmina con Fermo Interno Convesso Circlip Groove Female Convex Cone
DN	Inch	mm	mm	mm	mm	Codice / Part. nr.
3	1/8"	M 10x1	10,8	17	3,2	210 002 044
3	1/8"	G 3/8"-24	9	17	3,2	210 002 045
3	1/8"	G 3/8"-24	12	17	3,2	210 002 046
3	1/8"	M 10x1	18,5	17	3,2	210 002 047
3	1/8"	M 12x1	16,2	17	3,2	210 002 048

INTERNO CONVESSO
CONVEX CONE

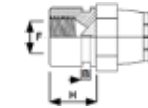

Tubo Hose	Filetto Thread	H	B	CH	Femmina con Fermo Interno Convesso Circlip Groove Female Convex Cone	Note	
DN	Inch	mm	mm	mm	Codice / Part. nr.		
3	1/8"	M 10x1	18,2	2,5	19	210 002 049	1 lato piano

INTERNO CONVESSO
CONVEX CONE

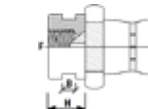

Tubo Hose	Filetto Thread	H	B	CH	Femmina con Fermo Interno Convesso Circlip Groove Female Convex Cone	Note
DN	Inch	mm	mm	mm	Codice / Part. nr.	
3	1/8"	M 10x1	9	3,2	210 002 050	1 lato piano fresato

RACCORDI FEMMINA CON FERMO



RACCORDI FRENO MONOPEZZO
MONO PIECE BRAKE FITTINGS

INTERNO CONVESSO
CONVEX CONE

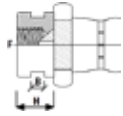

Tubo Hose		Filetto Thread	H	B	Femmina con Fermo Interno Concavo Circlip Groove Female Concave Internal	Note
DN	Inch	mm	mm	mm	Codice / Part. nr.	
3	1/8"	M 10x1	9,9	3,2	210 002 051	2 lati piani - 1 posizionatore
3	1/8"	M 10x1	9,8	3,2	210 002 052	2 lati piani
3	1/8"	M 10x1	9,4	3,2	210 002 053	2 lati piani con cava
3	1/8"	M 10x1	11	3,2	210 002 054	2 lati piani
3	1/8"	M 10x1	13,2	3,2	210 002 055	2 lati piani
3	1/8"	M 10x1	13	3,2	210 002 056	1 lato piano
3	1/8"	M 10x1	18	1,6	210 002 057	2 lati piani



RACCORDI MASCHIO - FEMMINA

RACCORDI FRENO MONOPEZZO
MONO PIECE BRAKE FITTINGS

INTERNO CONCAVO
CONCAVE INTERNAL

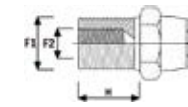

Tubo Hose		Filetto Maschio Male Thread	Filetto Femmina Female Thread	H	CH	Maschio - Femmina Interno Concavo Male - Female Concave Internal
DN	Inch	mm	mm	mm	mm	Codice / Part. nr.
3	1/8"	M 14x1,5	M 8x1,25	12,7	15	210 003 001
3	1/8"	M 16x1,5	M 10x1	17	17	210 003 002
3	1/8"	M 16x1,5	M 10x1	19	17	210 003 003
3	1/8"	M 16x1,5	M 10x1,25	12	17	210 003 008
3	1/8"	M 20x1,5	M 14x1,5	20	22	210 003 004
3	1/8"	G 5/8"-26	G 7/16"-20	18,7	17	210 003 005
3	1/8"	G 5/8"-26	G 3/8"-24	16	17	210 003 007

INTERNO CONVESSO
CONVEX CONE

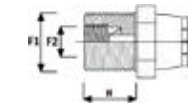

Tubo Hose		Filetto Maschio Male Thread	Filetto Femmina Female Thread	H	CH	Maschio - Femmina Interno Connesso Male - Female Convex Cone
DN	Inch	mm	mm	mm	mm	Codice / Part. nr.
3	1/8"	M 16x1,5	M 10x1,25	19	17	210 003 009

RACCORDI AD OCCHIO

RACCORDI FRENO MONOPEZZO
MONO PIECE BRAKE FITTINGS

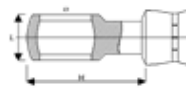

Tubo Hose		Ø Occhio Banjo Ø	H	L	Occhio Dritto Staright Banjo
DN	Inch	mm	mm	mm	Codice / Part. nr.
3	1/8"	10,1	28	8	202 002 301
3	1/8"	10,1	25	10	202 002 302
3	1/8"	10,1	33	10	202 002 303
3	1/8"	10,1	32	10	202 002 304

CON GANCIO
WITH CLIP

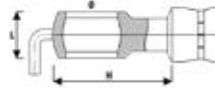

Tubo Hose		Ø Occhio Banjo Ø	H	L	Gancio Clip	Occhio Dritto con Gancio Staright Banjo with Clip	Note
DN	Inch	mm	mm	mm	mm	Codice / Part. nr.	
3	1/8"	10,1	28	8	90°	202 002 305	
3	1/8"	10,1	33	10	90°	202 002 306	
3	1/8"	10,1	28	8	90°	202 002 307	corpo esagonale
3	1/8"	10,1	28	8		202 002 308	corpo esagonale - spina elastica

INCLINATO A 15°
15° DEGREE

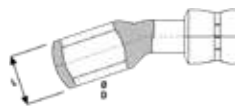

Tubo Hose		Ø Occhio Banjo Ø	L	Inclinazione Degree	Occhio Inclinato a 15° 15° Degree Banjo
DN	Inch	mm	mm	°	Codice / Part. nr.
3	1/8"	10,1	10	15°	202 002 309

RACCORDI AD OCCHIO

RACCORDI FRENO MONOPEZZO
MONO PIECE BRAKE FITTINGS

INCLINATO CON GANCIO
DEGREE WITH CLIP

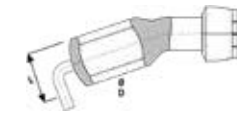

Tubo Hose		Ø Occhio Banjo Ø	H	Inclinazione Degree	Gancio Clip	Occhio Dritto con Gancio Staright Banjo with Clip	Note
DN	Inch	mm	mm	°	mm	Codice / Part. nr.	
3	1/8"	10,1	8	15°	90°	202 002 310	corpo esagonale

INCLINATO CON SPINA ELASTICA
DEGREE WITH SPRING PIN

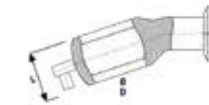

Tubo Hose		Ø Occhio Banjo Ø	L	Inclinazione Degree	Occhio Inclinato con Spina Elastica Degree Banjo with Spring Pin	Note
DN	Inch	mm	mm	°	Codice / Part. nr.	
3	1/8"	10,1	8	15°	202 002 311	corpo esagonale-spina elastica

INCLINATO LATERALE CON SPINA ELASTICA
LATERAL DEGREE WITH SPRING PIN



Tubo Hose		Ø Occhio Banjo Ø	L	Inclinazione Degree	Occhio Inclinato Laterale con Spina Elastica Lateral Degree Banjo with Spring Pin	Note
DN	Inch	mm	mm	°	Codice / Part. nr.	
3	1/8"	10,1	8	15° laterale	202 002 312	corpo esagonale - spina elastica

Corpo Squadrato
Squared Body



Tubo Hose		Ø Occhio Banjo Ø	L	Inclinazione Degree	Occhio Corpo Squadrato Squared Body Banjo
DN	Inch	mm	mm	°	Codice / Part. nr.
3	1/8"	10,1	10	10°	202 002 313
3	1/8"	12,1	10	10°	202 002 314

RACCORDI AD OCCHIO

RACCORDI FRENO MONOPEZZO
MONO PIECE BRAKE FITTINGS

CON GANCIO
WITH CLIP

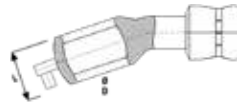

Tubo Hose	Ø Occhio Banjo Ø	H	L	Gancio Clip	Occhio Corto con Gancio Short Banjo with Clip
DN	Inch	mm	mm	mm	Codice / Part. nr.
3	1/8"	10,1	23	8	90° 202 002 315

CORPO QUADRATO
SQUARED BODY

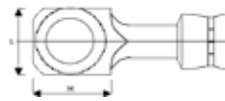

Tubo Hose	Ø Occhio Banjo Ø	H	L	Spessore Thickness	Occhio Squadrato Dritto Squared Body Banjo Straight
DN	Inch	mm	mm	mm	Codice / Part. nr.
3	1/8"	10,1	23	17	8 202 002 316
3	1/8"	10,1	23	16,8	11 202 002 317
3	1/8"	12,1	23	19	8 202 002 318

INCLINATO CORPO
SQUADRATO
DEGREE SQUARED
BODY

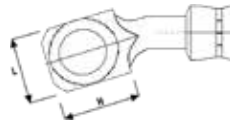

Tubo Hose	Ø Occhio Banjo Ø	H	L	Spessore Thickness	Inclinazione Degree	Occhio Squadrato Inclinato Squared Body Banjo Degree	Note
DN	Inch	mm	mm	mm	°	Codice / Part. nr.	
3	1/8"	10,1	23	17	8	10°	202 002 319
3	1/8"	10,1	23	16,8	11,2	10°	202 002 320 lungo 46 mm
3	1/8"	10,1	23	19,5	11,2	10°	202 002 321 lungo 55 mm
3	1/8"	12,1	23	22	8	18°	202 002 322

RACCORDI AD OCCHIO

RACCORDI FRENO MONOPEZZO
MONO PIECE BRAKE FITTINGS

CORPO QUADRATO
SQUARED BODY

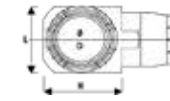

Tubo Hose	Ø Occhio Banjo Ø	H	L	Spessore Thickness	Occhio Squadrato Dritto Squared Body Banjo Straight
DN	Inch	mm	mm	mm	Codice / Part. nr.
3	1/8"	10,1	22,5	19	12 202 002 323

INCLINATO CORPO
SQUADRATO
DEGREE SQUARED
BODY

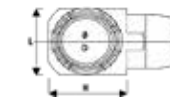

Tubo Hose	Ø Occhio Banjo Ø	H	L	Spessore Thickness	Inclinazione Degree	Occhio Squadrato Inclinato Squared Body Banjo Degree
DN	Inch	mm	mm	mm	°	Codice / Part. nr.
3	1/8"	10,1	22,5	20	12	10° 202 002 324

MONOBLOCCO
MONO BLOCK

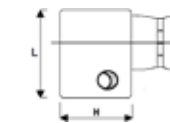

Tubo Hose	Ø Occhio Banjo Ø	H	L	Spessore Thickness	Occhio corpo Monoblocco Mono Block Banjo	Note
DN	Inch	mm	mm	mm	Codice / Part. nr.	
3	1/8"	10,1	25	27	16	202 002 325 con foro

RACCORDI AD OCCHIO



RACCORDI FRENO MONOPEZZO
MONO PIECE BRAKE FITTINGS

CORPO QUADRATO
CON POSIZIONATORE
SQUARED BODY WITH
POSITIONING

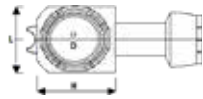

Tubo Hose		Ø Occhio Banjo Ø	H	L	Spessore Thickness	Occhio Squadrato Dritto Squared Body Banjo Straight	Note
DN	Inch	mm	mm	mm	mm	Codice / Part. nr.	
3	1/8"	10,1	23	17	8	202 002 326	con posizionale
3	1/8"	12,1	21	19	8	202 002 327	con posizionale
3	1/8"	12,1	26	19	8	202 002 328	con posizionale
3	1/8"	12,1	26	19	8	202 002 329	con posizionale lungo

INCLINATO CORPO
SQUADRATO CON
POSIZIONATORE
DEGREE SQUARED
BODY WITH
POSITIONING

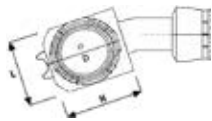

Tubo Hose		Ø Occhio Banjo Ø	H	L	Spessore Thickness	Inclinazione Degree	Occhio Squadrato Inclinato Squared Body Banjo Degree	Note
DN	Inch	mm	mm	mm	mm	°	Codice / Part. nr.	
3	1/8"	10,1	23	17	8	12°	202 002 330	con posizionale
3	1/8"	12,1	23,6	17	8	15°	202 002 331	con posizionale



FRENI & ARIA CONDIZIONATA
BRAKE & CONDITIONING AIR

TUBO RAME E ACCESSORI
COPPER TUBE & ACCESSORIES



DESCRIZIONE

Tubo rame nudo fabbricato secondo la normativa **UNI-EN 1057/DVGW** e ricotto (**R220**).

Fornito in rotoli.

La pressione massima di esercizio indicata è basata sull'uso di tubo di rame ricotto (R 200) e un valore di sicurezza di 3.5 ad una temperatura di 100 ° C.

DESCRIPTION

Copper tube manufactured according to the **UNI-EN 1057 / DVGW** and annealed (**R220**).

Supplied in rolls.

The maximum operating pressure indicated is based on the use of soft copper tube (R 200) and a safety value of 3.5 at a temperature of 100 ° C.



Codice Part Number	Ø Esterno O.D.	Pr. Esercizio Max WP	Pr. Scoppio Burst Pr.	Raggio Curv. Bend Radius	Peso Weight	Lunghezza Length
	mm	bar	bar	mm	Kg/mt	mt
115 000 410	4	1	382	R200	0,084	10 - 50
115 000 510	5	1	289	R220	0,112	10 - 50
115 000 610	6	1	229	R220	0,129	10 - 50
115 000 810	8	1	163	R220	0,180	10 - 50
115 001 010	10	1	127	R220	0,240	10 - 50
115 001 210	12	1	104	R220	0,284	10 - 50
115 001 510	15	1	82	R220	0,354	10 - 50
115 001 810	18	1	67	R220	0,422	10 - 50
115 002 210	22	1	54	R220	0,528	10 - 50

ARTICOLO IN NERETTO NORMATIVA EN 12449 - BOLD PART NUMBER STANDARD EN 12449

BICONI
CUTTING RING



Ø Esterno Tubo Tube OD	Pressione Pressure	Conf. Box	Bicono Ottone Brass Cutting Ring
mm	bar	pz./pcs	Codice / Part. nr.
4	150	10	582 000 004
5	150	10	582 000 005
6	150	10	582 000 006
8	135	10	582 000 008
10	95	10	582 000 010
12	75	10	582 000 012
14	85	10	582 000 014
15	82	10	582 000 015
16	76	10	582 000 016
18	67	10	582 000 018
22	54	10	582 000 022

DADI
NUT



Ø Esterno Tubo Tube OD	Filetto Thread	Pressione Pressure	Conf. Box	Dado di Serraggio Ottone Brass Nut
mm	mm	bar	pz./pcs	Codice / Part. nr.
4	M 8x1	150	10	581 104 080
5	M 10x1	150	10	581 105 100
6	M 10x1	150	10	581 106 100
8	M 12x1	135	10	581 108 120
10	M 16x1,5	95	10	581 110 162
12	M 18x1,5	75	10	581 112 182
14	M 20x1,5	85	10	581 114 202
15	M 20x1,5	82	10	581 115 202
16	M 22x1,5	76	10	581 116 222
18	M 24x1,5	67	10	581 118 242
22	M 30x1,5	54	10	581 122 302



**GIUNZIONI
COUPLING**



Ø Esterno Tubo Tube OD	Pressione Pressure		Giunzione Dritta Ottone Brass Straight Coupling
mm	bar		Codice / Part. nr.
4	150		598 004 000
5	150		598 005 000
6	150		598 006 000
8	135		598 008 000
10	95		598 010 000
12	75		598 012 000
14	85	●	598 014 000
15	82	●	598 015 000
16	76	●	598 016 000
18	67	●	598 018 000
22	54	●	598 022 000

**MASCHI GIREVOLI
SWIVEL MALE**



Ø Esterno Tubo Tube OD	Filetto Thread		Testina Maschio Girevole Swivel Male Fitting
mm	mm		Codice / Part. nr.
5	M 10x1	●	583 005 100
5	M 10x1,25	●	583 005 101
5	M 12x1	●	583 005 120
5	G 3/8"-24	●	583 005 006
6	M 10x1	●	583 006 100
6	M 10x1,25	●	583 006 101
6	M 12x1	●	583 006 120
6	G 3/8"-24	●	583 006 006

● Fornibile in 7 gg lavorativi / Available in 7 working days



**FRENI & ARIA CONDIZIONATA
BRAKE & CONDITIONING AIR**

**TUBI E RACCORDI PER ARIA CONDIZIONATA
AIR CONDITIONING HOSES & FITTINGS**



SISTEMI ARIA CONDIZIONATA AUTO
CARS AIR CONDITIONING SYSTEMS



IMPIEGO

Tubo per sistemi di **CONDIZIONAMENTO** nel settore **AUTOMOTIVE**. Idoneo per passaggio di refrigerante **R 134a** e **OLIO PAG**.

- Temperatura: da -40 °C a +115 °C

STRUTTURA

- Sottostrato: liscio **IIR (butile)** nero.
- Rinforzi: **2 treccie tessili**.
- Copertura: in **EPDM** nero resistente al calore, all'abrasione e all'invecchiamento.
- Superficie: liscia estrusa.
- Normativa di riferimento: **SAE J 2064 Tipo A**

APPLICATION

Hose for **CONDITIONING** in **AUTOMOTIVE** sector. Suitable for refrigerant **R 134a** and **PAG OIL**.

- Temperature range: -40 °C to +115 °C

CONSTRUCTION

- Tube: black, smooth **IIR (butyl)**.
- Reinforcement: **2 textile braids**.
- Cover: black, abrasion, heat and ageing resistant **EPDM**.
- Surface: smooth extruded.
- According to: **SAE J 2064 Type A**

Codice Part Number	Diametro Interno Inside Diameter			Ø Esterno O.D.	Pr. Esercizio Max WP	Pr. Scoppio Burst Pr.	Raggio Curv. Bend Radius	Peso Weight	Lunghezza Length
	DN	Inch	mm						
100 950 516	8	5/16"	8,0	18,2	35	> 160	60	0,26	20
100 951 332	11	13/32"	10,5	22,0	35	> 160	80	0,36	20
100 950 120	12	1/2"	12,7	24,4	35	> 160	95	0,41	20
100 950 580	16	5/8"	16,0	27,0	35	> 160	120	0,45	20



● Fornibile in 7 gg lavorativi / Available in 7 working days



SISTEMI ARIA CONDIZIONATA BUS
BUS AIR CONDITIONING SYSTEMS



IMPIEGO

Tubo per sistemi di **CONDIZIONAMENTO** nel settore **BUS**. Idoneo per passaggio di refrigerante **R 134a**, **R 404a** e **OLII PAG/POE**.

- Temperatura: da -40 °C a +125 °C

STRUTTURA

- Sottostrato: liscio **IIR (butile)** nero.
- Rinforzi: **1 treccia metallica**.
- Copertura: in gomma **CSM** nera.
- Superficie: liscia estrusa.
- Normativa di riferimento: **SAE J 2064 Tipo B**

APPLICATION

Hose for **CONDITIONING** in **BUS** sector. Suitable for refrigerant **R 134a**, **R 404a** and **PAG/POE OILS**.

- Temperature range: -40 °C to +125 °C

CONSTRUCTION

- Tube: black, smooth **IIR (butyl)**.
- Reinforcement: **1 steel braid**.
- Cover: black, **CSM** rubber.
- Surface: smooth extruded.
- According to: **SAE J 2064 Type B**

Codice Part Number	Diametro Interno Inside Diameter			Ø Esterno O.D.	Pr. Esercizio Max WP	Pr. Scoppio Burst Pr.	Raggio Curv. Bend Radius	Peso Weight	Lunghezza Length
	DN	Inch	mm						
100 960 316	5	3/16"	4,8	13,0	35	200,0	85	0,21	20
100 960 516	8	5/16"	8,0	17,2	35	200,0	85	0,32	20
100 961 332	11	13/32"	10,5	19,3	35	200,0	95	0,37	20
100 960 120	12	1/2"	12,7	23,4	35	200,0	115	0,53	20
100 960 580	16	5/8"	16,0	27,3	35	200,0	135	0,68	20
100 960 780	22	7/8"	22,0	31,2	35	200,0	155	0,71	20
100 961 180	28	1.1/8"	28,0	38,0	35	200,0	190	0,93	20



● Fornibile in 7 gg lavorativi / Available in 7 working days

GIUNZIONE TUBO-TUBO IN ACCIAIO



PER TUBO
"CLIMA CAR"
FOR "CLIMA CAR"
HOSE



Tubo Hose		Tubo Hose		Giunzione Tubo/Tubo Hose/Hose Splicer		Conf. Box		Giunzione Tubo/Tubo con Valvola per Ricarica Hose/Hose Spliver with Recharge Valve		Conf. Box	
DN	Inch	DN	Inch			Codice / Part. nr.	pz./pcs			Codice / Part. nr.	pz./pcs
8	5/16"	8	5/16"	●		190 516 516	10	●		191 516 516	10
11	13/32"	11	13/32"	●		190 332 332	10	●		191 332 332	10
12	1/2"	12	1/2"	●		190 120 120	10	●		191 120 120	10
16	5/8"	16	5/8"	●		190 580 580	10	●		191 580 580	10

PER TUBO "CLIMA CAR"
FOR "CLIMA CAR" HOSE



Tubo Hose		Giunzione Tubo/Tubo Hose/Hose Splicer		Conf. Box	
DN	Inch			Codice / Part. nr.	pz./pcs
8	5/16"	●		014 501 922	10
11	13/32"	●		014 502 427	10
12	1/2"	●		014 502 730	10
16	5/8"	●		014 502 932	10

A RICHIESTA ALTRI TIPI DI RACCORDI PER ARIA CONDIZIONATA IN ACCIAIO
OTHER AIR CONDITIONING STEEL FITTINGS ON REQUEST

● Fornibile in 7 gg lavorativi / Available in 7 working days

GIUNZIONE TUBO-TUBO IN ALLUMINIO



PER TUBO "CLIMA CAR"
FOR "CLIMA CAR"
HOSE



Tubo Hose		Tubo Hose		Giunzione Tubo/Tubo Hose/Hose Splicer		Conf. Box		Giunzione Tubo/Tubo con Valvola per Ricarica Hose/Hose Spliver with Recharge Valve		Conf. Box	
DN	Inch	DN	Inch			Codice / Part. nr.	pz./pcs			Codice / Part. nr.	pz./pcs
8	5/16"	8	5/16"	●		193 516 516	10	●		194 516 516	10
11	13/32"	11	13/32"	●		193 332 332	10	●		194 332 332	10
12	1/2"	12	1/2"	●		193 120 120	10	●		194 120 120	10
16	5/8"	16	5/8"	●		193 580 580	10	●		194 580 580	10

PER TUBO "CLIMA CAR"
FOR "CLIMA CAR" HOSE



Tubo Hose		Boccola in Alluminio Aluminium Ferrule		Conf. Box	
DN	Inch			Codice / Part. nr.	pz./pcs
8	5/16"	●		991 216 031	10
11	13/32"	●		991 216 032	10
12	1/2"	●		991 216 033	10
16	5/8"	●		991 216 034	10

A RICHIESTA ALTRI TIPI DI RACCORDI PER ARIA CONDIZIONATA IN ACCIAIO
OTHER AIR CONDITIONING STEEL FITTINGS ON REQUEST

● Fornibile in 7 gg lavorativi / Available in 7 working days

**PER TUBO
"CLIMA BUS"
FOR "CLIMA BUS"
HOSE**



Tubo Hose		Tubo Hose		Giunzione Tubo/Tubo Hose/Hose Splicer		Conf. Box
DN	Inch	DN	Inch	Codice / Part. nr.		pz./ pcs
5	3/16"	5	3/16"	●	391 316 316	10
8	5/16"	8	5/16"	●	391 516 516	10
11	13/32"	11	13/32"	●	391 332 332	10
12	1/2"	12	1/2"	●	391 120 120	10
16	5/8"	16	5/8"	●	391 580 580	10
22	7/8"	22	7/8"	●	391 780 780	10
28	1.1/8"	28	1.1/8"	●	391 118 118	10

**PER TUBO
"CLIMA BUS"
FOR "CLIMA BUS" HOSE**



Tubo Hose		Boccola Recuperabile Reusable Ferrule		Conf. Box
DN	Inch	Codice / Part. nr.		pz./ pcs
5	3/16"	014 620 316		10
8	5/16"	014 620 516		10
11	13/32"	014 620 332		10
12	1/2"	014 620 120		10
16	5/8"	014 620 580		10
22	7/8"	014 620 780		10
28	1.1/8"	014 621 118		10

A RICHIESTA ALTRI TIPI DI RACCORDI PER ARIA CONDIZIONATA IN ACCIAIO
OTHER AIR CONITIONING STEEL FITTINGS ON REQUEST

● Fornibile in 7 gg lavorativi / Available in 7 working days



PNEUMATICA
PNEUMATIC

TUBI RILSAN
RILSAN TUBES



IMPIEGO

Tubo Termoplastico **RILSAN®** utilizzato nelle applicazioni industriali e automotive che richiedono resistenza alle alte temperature. Idoneo alla conduzione di fluidi caldi (oli, combustibili, aria e fluidi refrigeranti) non a base acquosa.

- Temperatura: da -40 °C a +80 °C; per fluidi a base acquosa a +70 °C.

STRUTTURA

- Speciale Bio-polimero termoplastico denominato polifalammide (PPA) caratterizzato da eccellente resistenza all'invecchiamento termoossidativo al calore. Questo materiale è Biobased fino al 70% e favorisce la riduzione di emissioni di anidride carbonica (CO2). Garantisce un'ottima termoformatura, buone proprietà meccaniche e di resistenza all'abrasione, unitamente ad una elevata resistenza chimica e agli ambienti aggressivi.
- Normativa di riferimento: **DIN 74324/73378** per la gran parte della gamma.

APPLICATION

RILSAN® thermoplastic tubes used in the industrial or automotive applications that require resistance to high temperatures.

Suitable for conveying hot fluids (oils, fuels, air and refrigerant fluids) not water-based.

- Temperature range: -40 °C to +80 °C; for water-based fluids to +70 °C.

CONSTRUCTION

- Special thermoplastic Bio-polymer called PolyPhtalAmide (PPA) characterized by an excellent resistance to the thermo-oxydative heat aging. This material is Biobased up to 70% and it favors the emissions reduction of carbon dioxide (CO2). Provides excellent thermoforming, good mechanical properties and abrasion resistance, together with a high resistance to chemicals and to aggressive environments.
- According to: **DIN 74324/73378** for most of the range.



Codice Part Number	Ø Esterno O.D.	Ø Interno I.D.	Spessore Thickness	Pr. Esercizio Max WP	Pr. Scoppio Burst Pr.	Raggio Curv. Bend Radius	Peso Weight	Lunghezza Length
	mm	DN	bar	bar	bar	mm	Kg/mt	mt
• 115 300 204	4	2	1	44	132	16	9,7	100
• 115 300 304	4	3	0,5	19	56	28	5,7	100
• 115 300 305	5	3	1	33	100	20	12,9	100
• 115 300 355	5	3,5	0,75	23	70	25	10,3	100
• 115 300 406	6	4	1	28	84	30	16,2	100
• 115 300 456	6	4,5	0,75	19	56	32	12,7	100
• 115 300 608	8	6	1	20	60	40	22,6	100
• 115 300 610	10	6	2	33	100	55	51,7	50
• 115 300 710	10	7	1,5	23	70	58	41,2	50
• 115 300 810	10	8	1	16	48	60	29,1	50
• 115 300 812	12	8	2	28	84	60	64,7	50
• 115 300 912	12	9	1,5	20	60	60	50,9	50
• 115 301 012	12	10	1	12	36	85	35,6	50
• 115 301 014	14	10	2	23	68	75	77,6	50
• 115 301 214	14	12	1	10	30	90	42,0	50
• 115 301 215	15	12	1,5	16	48	90	65,5	50
• 115 301 216	16	12	2	20	60	95	90,6	50
• 115 301 418	18	14	2	17	51	190	101,0	50
• 115 301 620	20	16	2	16	48	200	90,6	50
• 115 301 822	22	18	2	13	39	200	133,0	50

• Fornibile in 7 gg lavorativi / Available in 7 working days



Codice Part Number	Ø Esterno O.D. mm	Ø Interno I.D. DN	Spessore Thickness bar	Pr. Esercizio Max WP bar	Pr. Scoppio Burst Pr. bar	Raggio Curv. Bend Radius mm	Peso Weight Kg/mt	Lunghezza Lenght mt
115 100 153	3	1,5	0,75	44	132	8	5,5	100
115 100 204	4	2	1	44	132	16	9,7	100
115 100 304	4	3	0,5	19	56	28	5,7	100
115 100 305	5	3	1	33	100	20	12,9	100
115 100 355	5	3,5	0,75	23	70	25	10,3	100
115 100 406	6	4	1	28	84	30	16,2	100
115 100 456	6	4,5	0,75	19	56	32	12,7	100
115 100 608	8	6	1	20	60	40	22,6	100
115 100 610	10	6	2	33	100	55	51,7	50
115 100 710	10	7	1,5	23	70	58	41,2	50
115 100 810	10	8	1	16	48	60	29,1	50
115 100 812	12	8	2	28	84	60	64,7	50
115 100 912	12	9	1,5	20	60	60	50,9	50
115 101 012	12	10	1	12	36	85	35,6	50
115 101 014	14	10	2	23	68	75	77,6	50
115 101 214	14	12	1	10	30	90	42,0	50
115 101 215	15	12	1,5	16	48	90	65,5	50
115 101 216	16	12	2	20	60	95	90,6	50
115 101 418	18	14	2	17	51	190	101,0	50
115 101 620	20	16	2	16	48	200	90,6	50
115 101 822	22	18	2	13	39	200	133,0	50



Codice Part Number	Ø Esterno O.D. mm	Ø Interno I.D. DN	Spessore Thickness bar	Pr. Esercizio Max WP bar	Pr. Scoppio Burst Pr. bar	Raggio Curv. Bend Radius mm	Peso Weight Kg/mt	Lunghezza Lenght mt
115 200 204	4	2	1	44	132	16	9,7	100
115 200 304	4	3	0,5	19	56	28	5,7	100
115 200 305	5	3	1	33	100	20	12,9	100
115 200 406	6	4	1	28	84	30	16,2	100
115 200 456	6	4,5	0,75	19	56	32	12,7	100
115 200 608	8	6	1	20	60	40	22,6	100
115 200 610	10	6	2	33	100	55	51,7	50
115 201 710	10	7	1,5	23	70	58	41,2	50
115 200 810	10	8	1	16	48	60	29,1	50
115 200 812	12	8	2	28	84	60	64,7	50
115 200 912	12	9	1,5	20	60	60	50,9	50
115 201 012	12	10	1	12	36	85	35,6	50
115 201 014	14	10	2	23	68	75	77,6	50
115 201 214	14	12	1	10	30	90	42,0	50
115 201 215	15	12	1,5	16	48	90	65,5	50
115 201 216	16	12	2	20	60	95	90,6	50
115 201 418	18	14	2	17	51	190	101,0	50
115 201 822	22	18	2	13	39	200	133,0	50



Codice Part Number	Ø Esterno O.D.	Ø Interno I.D.	Spessore Thickness	Pr. Esercizio Max WP	Pr. Scoppio Burst Pr.	Raggio Curv. Bend Radius	Peso Weight	Lunghezza Length
	mm	mm	mm	bar	bar	mm	Kg/mt	mt
115 400 204	4	2	1	44	132	16	9,7	100
115 400 304	4	3	0,5	19	56	28	5,7	100
115 400 305	5	3	1	33	100	20	12,9	100
115 400 406	6	4	1	28	84	30	16,2	100
115 400 610	8	6	1	20	60	40	22,6	100
115 400 810	10	7	1,5	23	70	58	41,2	50
115 400 812	10	8	1	16	48	60	29,1	50
115 400 912	12	8	2	28	84	60	64,7	50
115 401 012	12	9	1,5	20	60	60	50,9	50
115 401 014	12	10	1	12	36	85	35,6	50
115 401 214	14	10	2	23	68	75	77,6	50
115 401 215	14	12	1	10	30	90	42,0	50
115 401 216	15	12	1,5	16	48	90	65,5	50
115 401 418	16	12	2	20	60	95	90,6	50



Codice Part Number	Ø Esterno O.D.	Ø Interno I.D.	Spessore Thickness	Pr. Esercizio Max WP	Pr. Scoppio Burst Pr.	Raggio Curv. Bend Radius	Peso Weight	Lunghezza Length
	mm	mm	mm	bar	bar	mm	Kg/mt	mt
115 700 204	4	2	1	44	132	16	9,7	100
115 700 304	4	3	0,5	19	56	28	5,7	100
115 700 305	5	3	1	33	100	20	12,9	100
115 700 406	6	4	1	28	84	30	16,2	100
115 700 608	8	6	1	20	60	40	22,6	100
115 700 810	10	8	1	16	48	60	29,1	50
115 701 012	12	10	1	12	36	85	35,6	50



Codice Part Number	Ø Esterno O.D.	Ø Interno I.D.	Spessore Thickness	Pr. Esercizio Max WP	Pr. Scoppio Burst Pr.	Raggio Curv. Bend Radius	Peso Weight	Lunghezza Length
	mm	mm	mm	bar	bar	mm	Kg/mt	mt
115 500 204	4	2	1	44	132	16	9,7	100
115 500 304	4	3	0,5	19	56	28	5,7	100
115 500 305	5	3	1	33	100	20	12,9	100
115 500 406	6	4	1	28	84	30	16,2	100
115 500 608	8	6	1	20	60	40	22,6	100
115 500 810	10	8	1	16	48	60	29,1	50
115 500 812	12	8	2	28	84	60	64,7	50
115 500 912	12	9	1,5	20	60	60	50,9	50
115 501 012	12	10	1	12	36	85	35,6	50
115 501 214	14	12	1	10	30	90	42,0	50
115 501 215	15	12	1,5	16	48	90	65,5	50
115 501 216	16	12	2	20	60	95	90,6	50



Codice Part Number	Ø Esterno O.D.	Ø Interno I.D.	Spessore Thickness	Pr. Esercizio Max WP	Pr. Scoppio Burst Pr.	Raggio Curv. Bend Radius	Peso Weight	Lunghezza Length
	mm	mm	mm	bar	bar	mm	Kg/mt	mt
115 600 204	4	2	1	44	132	16	9,7	100
115 600 304	4	3	0,5	19	56	28	5,7	100
115 600 305	5	3	1	33	100	20	12,9	100
115 600 406	6	4	1	28	84	30	16,2	100
115 600 608	8	6	1	20	60	40	22,6	100
115 600 810	10	8	1	16	48	60	29,1	50
115 600 812	12	8	2	28	84	60	64,7	50
115 600 912	12	9	1,5	20	60	60	50,9	50
115 601 012	12	10	1	12	36	85	35,6	50
115 601 214	14	12	1	10	30	90	42,0	50
115 601 215	15	12	1,5	16	48	90	65,5	50

● Fornibile in 7 gg lavorativi / Available in 7 working days



IMPIEGO

Tubo Termoplastico **RILSAN® Bistrato** utilizzato per le connessioni **ad aria del sistema frenante** dei veicoli industriali.

- Temperatura: da -40 °C a +93 °C.

STRUTTURA

- Sottostrato: liscio **Nylon** nero.
- Rinforzo: **fibra sintetica**.
- Copertura: **Nylon** di colore nero.
- Normativa di riferimento: **SAE J 844 Tipo 3/B**

APPLICATION

RILSAN® Two Layer thermoplastic tube used for **air brake system** connections in the Truck.

- Temperature range: -40 °C to +93 °C.

CONSTRUCTION

- Tube: black, smooth **Nylon**.
- Reinforcement: **synthetic braid**.
- Cover: black, **Nylon**.
- According to: **SAE J 844 Type 3/B**



Codice Part Number	Ø Esterno O.D.	Ø Interno I.D.	Spessore Thickness	Pr. Esercizio Max WP	Pr. Scoppio Burst Pr.	Raggio Curv. Bend Radius	Peso Weight	Lunghezza Length
	mm	mm	mm	bar	bar	mm	Kg/mt	mt
115 200 710	10	7	1,5	31	93	60		25 - 100
115 208 812	12	8,8	1,6	27	81	70		25 - 100
115 211 316	16	11,3	2,35	27	81	90		25 - 100

**IDONEO PER I SEDILI DEI VEICOLI COMMERCIALI
USED FOR COMMERCIAL VEHICLE SEATS**



IMPIEGO

Tubo in **Poliuretano Super Flessibile** utilizzato per azionare i meccanismi **delle sedute dei veicoli commerciali**. Ridotto raggio di curvatura, ottima flessibilità con eccellente ripristino delle proprie caratteristiche in condizioni di bassa temperatura, buona resistenza alle piegature ed all'abrasione, resistente agli idrocarburi alifatici ed alla maggior parte dei lubrificanti ed all'invecchiamento da ossigeno.

- Temperatura: da -35 °C a +60 °C.

STRUTTURA

- Tubo: liscio **Poliestere Poliuretano**.
- Durezza: **52D Shores**.

APPLICATION

Extra Flexibe Polyurethane tube used to operate the mechanisms of **Commercial Vehicle Seats**. Small bend radius due to high flexibility, very good low temperature flexibility and reset characteristics, kink and abrasion resistant, resistant to aliphatic hydrocarbons and most lubricants, ageing resistance in oxygen.

- Temperature range: -35 °C to 60 °C.

CONSTRUCTION

- Tube: smooth **Polyester Polyurethane**.
- Hardness: **52D Shores**.



Codice Part Number	Ø Esterno O.D.	Ø Interno I.D.	Pr. Esercizio Max WP	Raggio Curv. Bend Radius	Peso Weight	Lunghezza Length	Colore Color
	mm	mm	bar	mm	Kg/mt	mt	mt
116 004 020	4	2	21	15		50 - 100	ROSSO
116 004 025	4	2,5	17	12		50	TRASPARENTE
116 004 330	4,3	3	15	12		50 - 100	NERO
116 104 330	4,3	3	15	12		50 - 100	BLU
116 204 330	4,3	3	15	12		50 - 100	NEUTRO
116 304 330	4,3	3	15	12		50 - 100	GIALLO
116 404 330	4,3	3	15	12		50 - 100	ROSSO
116 504 330	4,3	3	15	12		50 - 100	VERDE
116 006 040	6	4	14	20		50 - 100	ROSSO
116 008 060	8	6	12	25		50 - 100	ROSSO
116 010 080	10	8	8	45		50 - 100	ROSSO



PNEUMATICA
PNEUMATIC

ACCESSORI PER PNEUMATICA
PNEUMATIC ACCESSORIES



Ø Esterno Tubo Tube OD	Ogiva in Ottone Brass Sleeve	Conf. Box
mm	Codice / Part. nr.	pz./pcs
3	588 500 003	10
4	588 500 004	10
6	588 500 006	10
8	588 500 008	10
10	588 500 010	10
12	588 500 012	10
14	588 500 014	10
15	588 500 015	10
16	588 500 016	10
18	588 500 018	10
20	588 500 020	10

BUSSOLE DI RINFORZO



Ø Esterno Tubo Tube OD	Ø Interno Tubo Tube ID	Bussola di Rinforzo per Tubo Monostrato One Layer Tube Reinforcing Ring	Conf. Box	Bussola di Rinforzo per Tubo Bistrato Two Layer Tube Reinforcing Ring	Conf. Box
mm	mm	Codice / Part. nr.	pz./pcs	Codice / Part. nr.	pz./pcs
4	2	580 100 402	10		10
5	3	580 100 503	10		10
6	4	580 100 604	10		10
8	6	580 100 806	10		10
10	7	580 101 007	10	580 210 700	10
10	8	580 101 008	10		10
12	8,7		10	580 212 870	10
12	9	580 101 209	10		10
14	10	580 101 410	10		10
15	12	580 101 512	10		10
16	11,35		10	580 216 113	10
20	16	580 102 016	10		10

● Fornibile in 7 gg lavorativi / Available in 7 working days

CORPO IN
TECNOPOLIMERO
TECHNOPOLYMERIC
BODY



Ø Esterno Tubo Tube OD	Ø Interno Tubo Tube ID	Conf. Box	Raccordo Diritto Intermedio Straight Connector	Raccordo a L Intermedio Elbow Connector	Raccordo a T Intermedio Tee Connector
mm	mm	pz./pcs	Codice / Part. nr.	Codice / Part. nr.	Codice / Part. nr.
4	4	10	598 300 404	599 300 404	510 300 404
6	4	10	598 300 604		510 300 604
5	5	10	598 300 505		
6	6	10	598 300 606	599 300 606	510 300 606
8	4	10	598 300 804		510 300 804
8	6	10	598 300 806		510 300 806
8	8	10	598 300 808	599 300 808	510 300 808
10	6	10	598 301 006		510 301 006
10	8	10	598 301 008		510 301 008
10	10	10	598 301 010	599 301 010	510 301 010
12	8	10	598 301 208		510 301 208
12	10	10	598 301 210		510 301 210
12	12	10	598 301 212	599 301 212	510 301 212
14	08	2			510 301 408
14	14	2	598 301 414	599 301 414	510 301 414
15	15	2	598 301 515	599 301 515	510 301 515
16	12	2	598 301 612		
16	16	2	598 301 616	599 301 616	510 301 616
18	15	2			510 301 815
18	18	2	598 301 818	599 301 818	510 301 818
22	15	2			510 302 215
22	22	2	598 302 222	599 302 222	510 302 222
28	28	2	598 302 828	599 302 828	510 302 828
32	28	2	598 303 228		
32	32	2	598 303 322	599 303 232	510 303 232

● Fornibile in 7 gg lavorativi / Available in 7 working days



CORPO IN OTTONE
NICHELATO
NICKEL-PLATED
BRASS BODY



Ø Esterno Tubo Tube OD	Ø Interno Tubo Tube ID	Conf. Box	Raccordo Diritto Intermedio Straight Connector	Raccordo a L Intermedio Elbow Connector	Raccordo a T Intermedio Tee Connector
mm	mm	pz./pcs	Codice / Part. nr.	Codice / Part. nr.	Codice / Part. nr.
3	3	10	598 500 303		510 500 303
4	4	10	598 500 404	599 500 404	510 500 404
5	5	10	598 500 505	599 500 505	510 500 505
6	4	10	598 500 604		
6	6	10	598 500 606	599 500 606	510 500 606
8	6	10	598 500 806		
8	8	10	598 500 808	599 500 808	510 500 808
10	8	10	598 501 008		
10	10	10	598 501 010	599 501 010	510 501 010
12	12	10	598 501 212	599 501 212	510 501 212
14	14	10	598 501 414	599 501 414	510 501 414

CORPO IN
TECNOPOLIMERO
TECHNOPOLYMERIC
BODY



Ø Esterno Tubo Tube OD	Conf. Box	Regolatore Unidirezionale di Flusso in linea One-way Flow Control Push in Fitting
mm	pz./pcs	Codice / Part. nr.
4	5	559 030 004
6	5	559 030 006
8	5	559 030 008
10	5	559 030 010
12	5	559 030 012

● Fornibile in 7 gg lavorativi / Available in 7 working days



FILETTO "SHORT" - "SHORT" THREAD

FILETTO "SHORT"

La filettatura conica "short" è progettata per soddisfare le seguenti caratteristiche:

- ridurre la lunghezza d'ingombro
- ridurre la chiave rispetto ad alcuni raccordi con filettature cilindriche
- consentire l'accoppiamento con diversi standard di filettature femmina sia coniche che cilindriche:
- BSP e BSPP cilindrica; BSPT e NPT conica.
- Consentire una completa tenuta anche su superfici non perfettamente piane, concave, convesse o inclinate, con diversi smussi o raggi.

"SHORT" THREAD

The "short" taper thread has been designed to offer the following advantages to the users:

- reduced overall length;
- smaller hex dimensions compared to the parallel threads;
- to allow the assembly with different female threads both taper as well as parallel.
- BSP e BSPP parallel; BSPT e NPTF tapered.
- To ensure the right tightening also with surfaces not perfectly flat, without spot-facing, concave convex and with different kinds of chamfers or radius.

CORPO IN
TECNOPOLIMERO
TECHNOPOLYMERIC
BODY



Ø Esterno Tubo Tube OD	Filetto Thread	Conf. Box	Raccordo Diritto Maschio "Short" Straight "Short" Male Adaptor	Raccordo a L Orientabile Maschio "Short" Orienting Elbow "Short" Male Adaptor	Raccordo a TEE Orientabile Maschio "Short" Orienting TEE "Short" Male Adaptor
mm	mm	pz./pcs	Codice / Part. nr.	Codice / Part. nr.	Codice / Part. nr.
4	1/8"	10	592 400 402	594 400 402	596 400 402
4	1/4"	10	592 400 404	594 400 404	596 400 404
5	1/8"	10	592 400 502	594 400 502	
5	1/4"	10	592 400 504		
6	1/8"	10	592 400 602	594 400 602	596 400 602
6	1/4"	10	592 400 604	594 400 604	596 400 604
6	3/8"	10	592 400 606	594 400 606	
6	1/2"	10	592 400 608	594 400 608	
8	1/8"	10	592 400 802	594 400 802	596 400 802
8	1/4"	10	592 400 804	594 400 804	596 400 804
8	3/8"	10	592 400 806	594 400 806	596 400 806
8	1/2"	10	592 400 808	594 400 808	
10	1/4"	10	592 401 004	594 401 004	596 401 004
10	3/8"	10	592 401 006	594 401 006	596 401 006
10	1/2"	10	592 401 008	594 401 008	596 401 008
12	1/4"	10	592 401 204	594 401 204	596 401 204
12	3/8"	10	592 401 206	594 401 206	596 401 206
12	1/2"	10	592 401 208	594 401 208	596 401 208
14	3/8"	10	592 401 406	594 401 406	
14	1/2"	10	592 401 408	594 401 408	596 401 408

● Fornibile in 7 gg lavorativi / Available in 7 working days



FILETTO "SHORT" - "SHORT" THREAD

CORPO IN OTTONE
NICHELATO
NICKEL-PLATED
BRASS BODY



Ø Esterno Tubo Tube OD	Filetto Thread	Conf. Box	Raccordo Diritto Maschio "Short" Straight "Short" Male Adaptor	Raccordo a L Orientabile Maschio "Short" Orienting Elbow "Short" Male Adaptor	Raccordo a TEE Orientabile Maschio "Short" Orienting TEE "Short" Male Adaptor
mm	Inch	pz./pcs	Codice / Part. nr.	Codice / Part. nr.	Codice / Part. nr.
4	1/8"	10	● 592 500 402	● 594 500 402	● 596 500 402
4	1/4"	10	● 592 500 404	● 594 500 404	● 596 500 404
6	1/8"	10	● 592 500 602	● 594 500 602	● 596 500 602
6	1/4"	10	● 592 500 604	● 594 500 604	● 596 500 604
6	3/8"	10	● 592 500 606		
6	1/2"	10	● 592 500 608		
8	1/8"	10	● 592 500 802	● 594 500 802	● 596 500 802
8	1/4"	10	● 592 500 804	● 594 500 804	● 596 500 804
8	3/8"	10	● 592 500 806	● 594 500 806	● 596 500 806
8	1/2"	10	● 592 500 808	● 594 500 808	
10	1/4"	10	● 592 501 004	● 594 501 004	● 596 501 004
10	3/8"	10	● 592 501 006	● 594 501 006	● 596 501 006
10	1/2"	10	● 592 501 008	● 594 501 008	● 596 501 008
12	1/4"	10	● 592 501 204		
12	3/8"	10	● 592 501 206	● 594 501 206	● 596 501 206
12	1/2"	10	● 592 501 208	● 594 501 208	● 596 501 208
14	3/8"	10	● 592 501 406	● 594 501 406	
14	1/2"	10	● 592 501 408	● 594 501 408	

CORPO IN OTTONE
NICHELATO
NICKEL-PLATED
BRASS BODY



Ø Esterno Tubo Tube OD	Filetto Thread	Conf. Box	Regolatore Unidirezionale Orientabile per Cilindro M. "Short" "Short" Male Orienting Flow Regulator for Cylinder
mm	Inch	pz./pcs	Codice / Part. nr.
4	M5	10	● 559 050 002
5	M5	10	● 559 050 004
6	M5	10	● 559 050 007
6	1/8"	10	● 559 050 008
6	1/4"	10	● 559 050 009
8	1/8"	10	● 559 050 010
8	1/4"	10	● 559 050 011

● Fornibile in 7 gg lavorativi / Available in 7 working days



Ø Esterno Tubo Tube OD	Ø Interno Tubo Tube ID	Conf. Box	Raccordo Diritto Intermedio Straight Connector	Raccordo a L Intermedio Elbow Connector	Raccordo a T Intermedio Tee Connector
mm	mm	pz./pcs	Codice / Part. nr.	Codice / Part. nr.	Codice / Part. nr.
4 / 2,7	4 / 2,7	10	● 510 400 001	● 511 300 001	● 512 300 001
5 / 3	5 / 3	10	● 510 400 002	● 511 300 002	● 512 300 002
6 / 4	5 / 3	10	● 510 400 003		
6 / 4	6 / 4	10	● 510 400 004	● 511 300 003	● 512 300 003
8 / 6	6 / 4	10	● 510 400 005	● 511 300 004	● 512 300 004
8 / 6	8 / 6	10	● 510 400 006	● 511 300 005	● 512 300 005
10 / 8	6 / 4	10	● 510 400 007		● 512 300 006
10 / 8	8 / 6	10	● 510 400 008		● 512 300 007
10 / 8	10 / 8	10	● 510 400 009	● 511 300 006	● 512 300 008
12 / 10	12 / 10	10	● 510 400 010	● 511 300 007	● 512 300 009
15 / 12,5	15 / 12,5	10	● 510 400 011	● 511 300 008	● 512 300 010

RACCORDI A CALZAMENTO MASCHI



Ø Esterno Tubo Tube OD	Filetto Thread	Conf. Box	Raccordo Diritto Orientabile Maschio Orienting Straight Male Adaptor	Raccordo a L Orientabile Maschio Orienting Elbow Male Adaptor	Raccordo a TEE Orientabile Maschio Orienting TEE Male Adaptor
mm	Inch	pz./pcs	Codice / Part. nr.	Codice / Part. nr.	Codice / Part. nr.
4 / 2,7	1/8"	10		● 511 150 001	
6 / 4	1/8"	10	● 510 150 001	● 511 150 002	● 512 150 001
6 / 4	1/4"	10	● 510 150 002	● 511 150 003	● 512 150 002
8 / 6	1/8"	10	● 510 150 003	● 511 150 004	● 512 150 003
8 / 6	1/4"	10	● 510 150 004	● 511 150 005	● 512 150 004
10 / 6,5	1/4"	10	● 510 150 005		
10 / 8	1/8"	10			● 512 150 006
10 / 8	1/4"	10	● 510 150 006		● 512 150 005
12 / 8	3/8"	10	● 510 150 007		
12 / 10	3/8"	10	● 510 150 008		

● Fornibile in 7 gg lavorativi / Available in 7 working days

CORPO IN TECNOPOLIMERO
TECHNOPOLYMERIC BODY
Contenuto Assortimento
Assortiment Contents
(159 pz.)



Tipo Raccordo Fitting Type	Misure Size	Pz. / Pcs.	Assortimento Raccordi per Pneumatica Assortiment Pneumatic Fittings Codice / Part. nr.
Automatici Maschi Diritti	Per Tubo Ø 4 - 6 - 8 Filettature M5 - R 1/8" - R 1/4"	70	999 001 071
Automatici Maschi a L	Per Tubo Ø 4 - 6 - 8 Filettature M5 - R 1/8" - R 1/4"	37	
Automatici Intermedi Diritti	Per Tubo Ø 4 - 6 - 8	21	
Automatici Intermedi a T	Per Tubo Ø 4 - 6 - 8	21	
Automatici Intermedi Diritti Ridotti	Per Tubo Ø 4 - 6 - 8	10	
Taglierina Tubo		1	

CORPO IN OTTONE NICHELATO
NICKEL-PLATED BRASS BODY
Contenuto Assortimento
Assortiment Contents
(162 pz.)



Tipo Raccordo Fitting Type	Misure Size	Pz. / Pcs.	Assortimento Raccordi per Pneumatica Assortiment Pneumatic Fittings Codice / Part. nr.
Automatici Maschi Diritti	Per Tubo Ø 4 - 6 - 8 Filettature M5 - R 1/8" - R 1/4"	70	999 001 072
Automatici Maschi a L	Per Tubo Ø 4 - 6 - 8 Filettature M5 - R 1/8" - R 1/4"	40	
Automatici Intermedi Diritti	Per Tubo Ø 4 - 6 - 8	21	
Automatici Intermedi a T	Per Tubo Ø 4 - 6 - 8	21	
Automatici Intermedi Diritti Ridotti	Per Tubo Ø 4 - 6 - 8	10	
Taglierina Tubo		1	

● Fornibile in 7 gg lavorativi / Available in 7 working days

PRESE AD INNESTO RAPIDO
QUICK COUPLINGS



Un'unica presa per 4 tipi di innesti

È un dato di fatto che sul mercato esistono vari profili di innesti ben distinti sia nella forma che nelle dimensioni e generalmente necessitano di essere assemblati con specifiche prese che di norma non sono intercambiabili fra di loro. Per poter ovviare a questa incompatibilità proponiamo una soluzione pratica ed economica, un'unica presa da utilizzare con 4 differenti tipi di profili garantendo per tutti una perfetta tenuta.

One socket for 4 different plugs

It is a matter of fact that on the market are available various types of plugs well distinguished whether on the shape or on the dimensions, usually they need to be assembled with specific sockets which normally are not interchangeable. To get round to this incompatibility we offer a practical and cost-effective solution, a unique socket to be used with 4 different types of plugs, ensuring a perfect tightening.

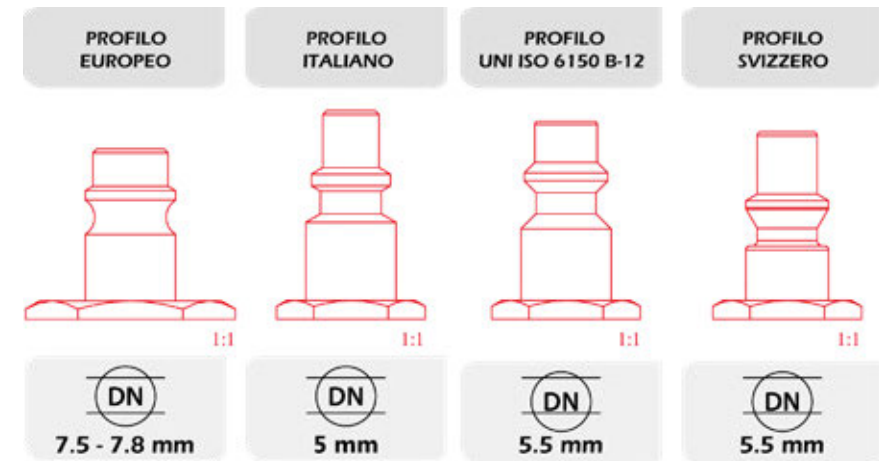

MULTIPRESE AD INNESTO RAPIDO



Filetto Thread	Confezione Box	Multipresa con Attacco Maschio Male Thread Multisocket Coupling	Multipresa con Attacco Femmina Female Thread Multisocket Coupling
Inch	pz./pcs	Codice / Part. nr.	Codice / Part. nr.
1/4"	10	701 910 001	701 920 001
3/8"	10	701 910 002	701 920 002
1/2"	10	701 910 003	701 920 003



Portagomma Hose Connector	Confezione Box	Multipresa con Attacco Maschio Male Thread Multisocket Coupling
Inch	pz./pcs	Codice / Part. nr.
14 / 6	10	701 960 001
17 / 8	10	701 960 002
19 / 10	10	701 960 003

INNESTI DI ACCOPPIAMENTO



PROFILO ITALIANO
Italian Profile



Filetto Thread	Confezione Box	Innesto con Attacco Maschio Male Thread Quick Coupling	Innesto con Attacco Femmina Female Thread Quick Coupling
Inch	pz./pcs	Codice / Part. nr.	Codice / Part. nr.
1/4"	10	702 510 103	702 520 103
3/8"	10	702 510 104	702 520 104
1/2"	10	702 510 105	702 520 105



Portagomma Hose Connector	Confezione Box	Innesto con Attacco Portagomma Plug for Rubber Hose Quick Coupling
Inch	pz./pcs	Codice / Part. nr.
14 / 6	10	702 660 001
17 / 8	10	702 660 002
19 / 10	10	702 660 003



1:1

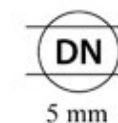

● Fornibile in 7 gg lavorativi / Available in 7 working days



Filetto Thread	Confezione Box		Preso "Nitto" con Attacco Maschio Male Thread "Nitto" Socket Coupling		Preso "Nitto" con Attacco Femmina Female Thread "Nitto" Socket Coupling
Inch	pz./pcs		Codice / Part. nr.		Codice / Part. nr.
1/4"	10	●	701 970 001	●	701 980 001
3/8"	10	●	701 970 002	●	701 980 002
1/2"	10	●	701 970 003	●	701 980 003



Portagomma Hose Connector	Confezione Box		Preso "Nitto" con Attacco Portagomma Plug for Rubber Hose "Nitto" Socket Coupling
Inch	pz./pcs		Codice / Part. nr.
8	10	●	701 990 001
10	10	●	701 990 002
12	10	●	701 990 003



PROFILO
GIAPPONESE
Japanese
Profile



Filetto Thread	Confezione Box		Preso "Nitto" con Attacco Maschio Male Thread "Nitto" Socket Coupling		Preso "Nitto" con Attacco Femmina Female Thread "Nitto" Socket Coupling
Inch	pz./pcs		Codice / Part. nr.		Codice / Part. nr.
1/4"	10	●	702 570 001	●	702 580 001
3/8"	10	●	702 570 002	●	702 580 002
1/2"	10	●	702 570 003	●	702 580 003



Portagomma Hose Connector	Confezione Box		Innesto "Nitto" con Attacco Portagomma Plug for Rubber Hose "Nitto" Quick Coupling
Inch	pz./pcs		Codice / Part. nr.
8	10	●	702 590 001
10	10	●	702 590 002
12	10	●	702 590 003

DN 7,5 mm

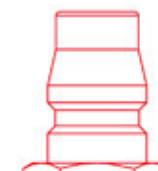
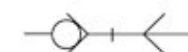

CORPO IN OTTONE NICHELATO
NICKEL-PLATED BRASS BODY



Filetto Thread	Ø Esterno Tubo Tube OD	Ø Interno Tubo Tube ID	Max spessore Parete Wall Thickness Max	Conf. Box	Presa di Accoppiamento Passaparete Bulkhead Coupling Socket
mm	mm	mm		pz./pcs	Codice / Part. nr.
M 8 x 0,5	6	4	8,5	10	● 702 700 001
M 10 x 1	6	4	6	10	● 702 700 002
M 12 x 1	8	6	5	10	● 702 700 003

CORPO IN OTTONE NICHELATO
NICKEL-PLATED BRASS BODY



Filetto Thread	Ø Esterno Tubo Tube OD	Ø Interno Tubo Tube ID	Max spessore Parete Wall Thickness Max	Conf. Box	Innesto di Accoppiamento Passaparete Bulkhead Coupling Plug
mm	mm	mm		pz./pcs	Codice / Part. nr.
M 8 x 0,5	6	4	8,5	10	● 702 710 001
M 10 x 1	6	4	9	10	● 702 710 002
M 12 x 1	8	6	9	10	● 702 710 003

CORPO IN OTTONE
BRASS BODY



Ø Interno Tubo 1 Ø Internal Hose 1	Ø Interno Tubo 2 Ø Internal Hose 2	Conf. Box	Diritto di Giunzione Tubo/Tubo Straight push in fitting	TEE di Giunzione Tubo/Tubo TEE push in fitting
mm	mm	pz./pcs	Codice / Part. nr.	Codice / Part. nr.
3	3	10	● 702 720 003	● 702 740 003
4	4	10	● 702 720 004	● 702 740 004
6	6	10	● 702 720 006	● 702 740 006

CORPO IN PLASTICA (POM)
PLASTIC (POM) BODY



Ø Interno Tubo 1 Ø Internal Hose 1	Ø Interno Tubo 2 Ø Internal Hose 2	Conf. Box	Diritto di Giunzione Tubo/Tubo Straight push in fitting	TEE di Giunzione Tubo/Tubo TEE push in fitting
mm	mm	pz./pcs	Codice / Part. nr.	Codice / Part. nr.
3	3	10	● 702 730 003	● 702 750 003
4	4	10	● 702 730 004	● 702 750 004
6	6	10	● 702 730 006	● 702 750 006

NIPPLI GAS CILINDRICI



CORPO IN OTTONE NICHELATO
NICKEL-PLATED
BRASS BODY



Filetto Thread	Filetto Thread	Conf. Box	Nipplo Gas Cilindrico BSP Nipple Parallel		Filetto Thread	Filetto Thread	Conf. Box	Nipplo di Riduzione Gas Cilindrico BSP Reducing Nipple Parallel	
Inch	Inch	pz./pcs	Codice /	Part. nr.	Inch	Inch	pz./pcs	Codice /	Part. nr.
1/8"	1/8"	10	●	530 000 202	1/4"	1/8"	10	●	534 000 402
1/4"	1/4"	10	●	530 000 404	3/8"	1/8"	10	●	534 000 602
3/8"	3/8"	10	●	530 000 606	3/8"	1/4"	10	●	534 000 604
1/2"	1/2"	10	●	530 000 808	1/2"	1/4"	10	●	534 000 804
3/4"	3/4"	10	●	530 001 212	1/2"	3/8"	10	●	534 000 806
1"	1"	10	●	530 001 616	3/4"	1/2"	10	●	534 001 208

RIDUZIONI M/F GAS CILINDRICI

CORPO IN OTTONE NICHELATO
NICKEL-PLATED
BRASS BODY



Filetto G1 G1 Thread	Filetto G2 G2 Thread	Conf. Box	Riduzione Alta M/F Gas Cilindrica M/F BSP Long Reducing		Filetto G1 G1 Thread	Filetto G2 G2 Thread	Conf. Box	Riduzione Bassa M/F Gas Cilindrica M/F BSP Short Reducing	
Inch	Inch	pz./pcs	Codice /	Part. nr.	Inch	Inch	pz./pcs	Codice /	Part. nr.
1/8"	1/8"	10	●	540 040 202	1/4"	1/8"	10	●	540 030 402
1/8"	1/4"	10	●	540 040 204	3/8"	1/8"	10	●	540 030 602
1/8"	3/8"	10	●	540 040 206	3/8"	1/4"	10	●	540 030 604
1/4"	1/4"	10	●	540 040 404	1/2"	1/8"	10	●	540 030 802
1/4"	3/8"	10	●	540 040 406	1/2"	1/4"	10	●	540 030 804
1/4"	1/2"	10	●	540 040 408	1/2"	3/8"	10	●	540 030 806
3/8"	3/8"	10	●	540 040 606	3/4"	1/4"	10	●	540 031 204
3/8"	1/2"	10	●	540 040 608	3/4"	3/8"	10	●	540 031 206
1/2"	1/2"	10	●	540 040 808	3/4"	1/2"	10	●	540 031 208

● Fornibile in 7 gg lavorativi / Available in 7 working days

MANICOTTI GAS CILINDRICI



CORPO IN OTTONE NICHELATO
NICKEL-PLATED
BRASS BODY



Filetto Thread	Filetto Thread	Conf. Box	Manicotto Gas Cilindrico BSP Sleeve Parallel		Filetto Thread	Filetto Thread	Conf. Box	Manicotto di Riduzione Gas Cilindrico BSP Reducing Sleeve Parallel	
Inch	Inch	pz./pcs	Codice /	Part. nr.	Inch	Inch	pz./pcs	Codice /	Part. nr.
1/8"	1/8"	10	●	540 020 202	1/4"	1/8"	10	●	540 020 402
1/4"	1/4"	10	●	540 020 404	3/8"	1/8"	10	●	540 020 602
3/8"	3/8"	10	●	540 020 606	3/8"	1/4"	10	●	540 020 604
1/2"	1/2"	10	●	540 020 808	1/2"	1/8"	10	●	540 020 802
3/4"	3/4"	10	●	540 021 212	1/2"	1/4"	10	●	540 020 804
1"	1"	10	●	540 021 616	1/2"	3/8"	10	●	540 020 806
					3/4"	1/2"	10	●	540 021 208
					1"	1/2"	10	●	540 021 608
					1"	3/4"	10	●	540 021 612

ADATTATORI STAMPATI GAS CILINDRICI

CORPO IN OTTONE NICHELATO
NICKEL-PLATED
BRASS BODY



Filetto Thread	Filetto Thread	Conf. Box	Gomito M.conico/F.Gas Cilindrico M.BSPT/F.BSP Elbow Parallel		Gomito F/F Gas Cilindrico F/F BSP Elbow Parallel	TEE F/F/F Gas Cilindrico F/F/F BSP TEE Parallel
Inch	Inch	pz./pcs	Codice /	Part. nr.	Codice /	Part. nr.
1/8"	1/8"	10	●	540 280 202	●	540 230 202
1/4"	1/4"	10	●	540 280 404	●	540 230 404
3/8"	3/8"	10	●	540 280 606	●	540 230 606
1/2"	1/2"	10	●	540 280 808	●	540 230 808
3/4"	3/4"	10	●	540 281 212	●	540 231 212
1"	1"	10	●	540 281 616	●	540 231 616

● Fornibile in 7 gg lavorativi / Available in 7 working days



LUBRIFICAZIONE
LUBRIFICATION

INGRASSAGGIO
GREASING



Filetto Thread	Conf. Box	Ingrassatori Testa Tonda Diritti Tipo H1 - DIN 71412 A Ball Grease Nipple Straight Type H1 - DIN 71412 A	Ingrassatori TestaTonda a 45° Tipo H2 - DIN 71412 A Ball Grease Nipple 45° Type H2 - DIN 71412 A	Ingrassatori TestaTonda a 90° Tipo H3 - DIN 71412 A Ball Grease Nipple 90° Type H3 - DIN 71412 A
		pz./pcs	Codice / Part. nr.	Codice / Part. nr.
M 6x1	10	025 010 100	025 045 100	025 090 100
M 8x1	10	025 010 200	025 045 200	025 090 200
M 8x1,25	10	025 010 300	025 045 300	025 090 300
M 10x1	10	025 010 400	025 045 400	025 090 400
M 10x1,5	10	025 010 500	025 045 500	025 090 500
G 1/8"	10	025 010 600	025 045 600	025 090 600
G 1/4"	10	025 010 700	025 045 700	025 090 700



Filetto Thread	Conf. Box	Ingrassatori Diritti Tipo D1 - DIN 3405 A Grease Nipple Straight Type D1 - DIN 3405 A	Ingrassatori a 45° Tipo D2 - DIN 3405 B Grease Nipple 45° Type D2 - DIN 3405 B	Ingrassatori a 90° Tipo D3 - DIN 3405 C Grease Nipple 90° Type D3 - DIN 3405 C
		pz./pcs	Codice / Part. nr.	Codice / Part. nr.
M 6x1	10	027 010 100	027 045 100	027 090 100
M 8x1	10	027 010 200	027 045 200	027 090 200
M 8x1,25	10	027 010 300		
M 10x1	10	027 010 400	027 045 400	027 090 400
M 10x1,5	10			
G 1/8"	10	027 010 600	027 045 600	027 090 600



Filetto Thread	Conf. Box	Ingrassatori Testa Piana d.10 mm. Tipo M4 - DIN 3404 Flat Grease Nipple d.10 mm. Type M4 - DIN 3404	Ingrassatori Testa Piana d.16 mm. Tipo M1 - DIN 3404 Flat Grease Nipple d.16 mm. Type M1 - DIN 3404	Ingrassatori Testa Piana d.22 mm. Tipo M22 - DIN 3404 Flat Grease Nipple d.22 mm. Type M22 - DIN 3404
		pz./pcs	Codice / Part. nr.	Codice / Part. nr.
M 6x1	10	026 010 100	026 016 100	
M 8x1	10	026 010 200	026 016 200	
M 8x1,25	10		026 016 300	
M 10x1	10	026 010 400	026 016 400	
M 10x1,5	10		026 016 500	
M 16x1,5	10			026 022 550
G 1/8"	10	026 010 600	026 016 600	
G 1/4"	10		026 016 700	026 022 700
G 3/8"	10			026 022 800



Filetto Thread	Conf. Box	Testina 4 Griffe per Ingrassatori Testa Tonda Coupling with 4 Cheeks for Ball Grease Nipple
		pz./pcs
M 10x1	10	028 010 100
G 1/8"	10	028 010 180



Ø Testa Ingrassatore Ø Head Grease Nipple	Filetto Thread	Conf. Box	Testina a Gancio in Ottone per Ingrassatori Testa Piana Brass Coupling for Flat Grease Nipple
			pz./pcs
10	G 1/8"	10	029 010 180
16	G 1/8"	10	029 016 180
16	M 10x1	10	029 016 200
22	G 1/8"	10	029 022 180

● Fornibile in 7 gg lavorativi / Available in 7 working days



Lunghezza Length	Raccordi Fittings	Tube in Nyloflow per Ingrassatori Nyloflow Greasing Hose
mm	mm	Codice / Part. nr.
400	M 10x1	030 000 400
700	M 10x1	030 100 500

ASSORTIMENTO INGRASSATORI

Contenuto Assortimento
Assortiment Contents



Tipo Ingrassatore Greasing Nipple Type	Misure Size	Pz. / Pcs.	Assortimento Ingrassatori Assortiment Greasing Nipples
Codice / Part. nr.			
Testa Tonda DIN 71412 A	Diritti - 45° - 90°	80 ●	031 000 001
Testa Tonda DIN 71412 A Testa Piana d.16	Diritti - 45° - 90°	170 ●	031 000 002
Testa Tonda DIN 71412 A Testa Piana d.16 e d.22	Diritti - 45° - 90°	350 ●	031 000 003

● Fornibile in 7 gg lavorativi / Available in 7 working days



Per Cartuccia da For Cartridge of	Ingrassatore Manuale per Cartucce Completo di Tubo e Testina Hand Operated Cartridge Pump Hose and Coupling Complete
gr	Codice / Part. nr.
400	032 000 100
600	032 000 200



Coprifusto Cover	Disco Plate	Lunghezza Tubo Hose Length	Lunghezza Asta Pompante Shaft Length	Pompa a Leva per Grasso Lever Grease Pump
mm	mm	mm	mm	Codice / Part. nr.
310	300	1500	370 ●	033 000 100



Filetto Thread	Pistola con Terminale Flessibile per Pompe Pneumatiche Air Operated Pump Grease Gun with Hose
Inch	Codice / Part. nr.
G 1/4"	032 000 300

● Fornibile in 7 gg lavorativi / Available in 7 working days

GRASSO VERDE / GREEN GREASE



CARATTERISTICHE

OTTIMA resistenza a pressioni, acqua, anche salata, e umidità. Eccezionale potere adesivo ed ottima stabilità meccanica.

- Temperatura d'imp.: -10 + 160°C.

FEATURES

EXCELLENT EP resistance, water and humidity resistance as well as salt water resistance. Outstanding adhesiveness and excellent mechanical stability.

- Temperature use: -10 °C to +140 °C



Tipo di Grasso Grease Type	Casrtuccia da 400 gr. 400 gr Cartridge	Pz. Pcs.	Fusto Drum	Pz. Pcs.
Codice / Part. nr.		Codice / Part. nr.		
KAPPA	● 996 940 400	12	● 996 940 020	20

GRASSO GIALLO / YELLOW GREASE

CARATTERISTICHE

Grasso ad alto rendimento, resistente a pressioni elevatissime. Resistente ad acqua e acqua salata. Potere adesivo particolarmente pronunciato.

- Temperatura d'imp.: -15 + 100°C.

FEATURES

High performance grease with excellent resistance to extreme pressures. Water resistance as well as salt water resistance. Particularly strong adhesiveness.

- Temperature use: -15 °C to +100 °C



Tipo di Grasso Grease Type	Casrtuccia da 400 gr. 400 gr Cartridge	Pz. Pcs.	Fusto Drum	Pz. Pcs.
Codice / Part. nr.		Codice / Part. nr.		
ULTRA	● 996 950 400	12	● 996 950 020	20

GRASSO BLU / BLUE GREASE

CARATTERISTICHE

Grasso al litio complesso dalle prestazioni estremamente elevate indicato per un'ampia gamma di applicazioni e condizioni operative severe.

- Temperatura d'imp.: -10 + 140°C.

FEATURES

Lithium complex grease of extremely high performance suitable for a wide range of applications and severe operating conditions.

- Temperature use: -10 °C to +140 °C.



Tipo di Grasso Grease Type	Casrtuccia da 400 gr. 400 gr Cartridge	Pz. Pcs.	Fusto Drum	Pz. Pcs.
Codice / Part. nr.		Codice / Part. nr.		
XHP222	● 996 960 400	12	● 996 960 018	18
HSR Blu	● 996 960 401	15	● 996 980 020	20

GRASSO NERO / BLACK GREASE



CARATTERISTICHE

Grasso ad alto rendimento, resistente a pressioni elevate. Multifunzione per applicazioni gravose con Mso2 bisolfuro di molibdeno additivo antiusura.

- Temperatura d'imp.: -20 + 130°C

FEATURES

High-yielding grease, resistant to high pressure. Multifunction for heavy duty applications with Mso2 molybdenum disulfide anti-wear additive.

- Temperature use: -20 °C to +130 °C.



Tipo di Grasso Grease Type	Casrtuccia da 400 gr. 400 gr Cartridge	Pz. Pcs.	Fusto Drum	Pz. Pcs.
Codice / Part. nr.		Codice / Part. nr.		
XHP222	● 996 970 400	12	● 996 970 018	18
HSR Blu	● 996 990 400	15	● 996 990 020	20

GRASSO MARRONE / BROWN GREASE

CARATTERISTICHE

Grasso al litio ad alte prestazioni multifunzione con eccellente protezione contro ruggine, corrosione e dilavamento.

- Temperatura d'imp.: -20 + 130°C.

FEATURES

Lithium grease high-performance multifunctional with excellent protection against rust, corrosion and water washout.

- Temperature use: -20 °C to +130 °C.



Tipo di Grasso Grease Type	Casrtuccia da 400 gr. 400 gr Cartridge	Pz. Pcs.	Fusto Drum	Pz. Pcs.
Codice / Part. nr.		Codice / Part. nr.		
MILUX EP2	● 996 980 400	12	● 996 980 018	18
HSR LI EP2	●		● 996 104 018	18

GRASSO BIANCO / WHITE GREASE

CARATTERISTICHE

Grasso speciale puro privo di odore e sapore resistente alle alte temperature. Multifunzione utilizzato in ambienti atossici. Resiste a umidità, vapore, acidi, detersivi e disinfettanti. Conforme alla norma USDA H1 alimentare.

- Temperatura d'imp.: -20 + 180°C.

FEATURES

Special pure grease without taste and odor resistant to high temperatures. Multifunction used in toxic environments. It resists humidity, steam, acids, detergents and disinfectants. Conforms to USDA H1 food legislation.

- Temperature use: -20 °C to +180 °C



Tipo di Grasso Grease Type	Casrtuccia da 400 gr. 400 gr Cartridge	Pz. Pcs.	Fusto Drum	Pz. Pcs.
Codice / Part. nr.		Codice / Part. nr.		
SORAJA C532	● 996 945 400	12	● 996 945 018	18

● Fornibile in 7 gg lavorativi / Available in 7 working days



LUBRIFICAZIONE
LUBRIFICATION

OLIO
OIL

DESCRIZIONE

Olio minerale paraffinico per trasmissioni idrauliche, contenente additivi antiossidante, antischiuma, anticorrosione e particolari additivi antiusura. Viene utilizzato quale olio minerale per trasmissioni idrauliche, additivati antiusura con superamento della prova FZG (a 8.3/90) all'11° stadio. Indicato per applicazioni in comandi idraulici per garantire lunghi periodi di esercizio.

Le caratteristiche principali sono:

- Notevoli proprietà antiusura, anticorrosione, antiruggine ed antischiuma.
- Alta stabilità termica ed all'ossidazione.
- Eccellente demulsività.

CARATTERISTICHE

- Gradazione ISO 3448: **ISO VG 46.**
 - Densità a 15 °C (ASTM D 1298): **Kg/m³ 875.**
 - Viscosità a 40 °C (ASTM D 445): **mm²/s 46.**
 - Indice di Viscosità (ASTM D 2270): **100.**
 - Punto di scorrimento (ASTM D 97): **-27 °C.**
 - Carico di 1° ingranamento (IP 239): **Kg >65.**
 - FZG (DIN 51354 part 2): **Supera 11° Stadio.**
- Specifiche: **ISO - L - HM; DIN 51524 Part 2 (HLP); CINCINNATI MILACRON P 68 - P 69 - P 70; VICKERS I - 286 - S / M - 2950 - S; AFNOR E 48-603; DENISON HF 1, HF 2, HF 0; FORD M-6 C 32.**



Fusto Drum	Olio Idraulico HLP 46 HLP 46 Hydraulic Oil	
lt	Codice / Part. nr.	
10	●	996 500 010
20	●	996 500 020
208	●	996 500 208

DESCRIZIONE

Fluido per trasmissioni automatiche servosterzo di vetture, veicoli commerciali ed industriali e per comandi idrostatici.

Formulato con componenti che conferiscono le peculiari proprietà richieste dalla specifica GM Dexron II D per quanto riguarda elevata resistenza all'ossidazione, ottimo scorrimento a bassa temperatura, alto indice di viscosità, protezione antiusura ed opportune caratteristiche d'attrito atte a consentire innesti morbidi e silenziosi nelle trasmissioni e maggiore durata dei componenti meccanici.

Per quanto riguarda la sostituzione, si raccomanda sempre di seguire le indicazioni del costruttore.

In generale, sostituire dopo 40.000 km nelle vetture, una volta l'anno nei veicoli industriali e dopo 800-1000 ore di lavoro nelle macchine agricole e movimento terra.

CARATTERISTICHE

- Colore: Rosso.
- Densità a 15 °C (ASTM D 1298): **Kg/m³ 870.**
- Viscosità a 100 °C (ASTM D 445): **mm²/s 7,5.**
- Viscosità a 40 °C (ASTM D 445): **mm²/s 36.**
- Indice di Viscosità (ASTM D 2270): **160.**
- Punto di infiammabilità, C.O.C. (ASTM D 92): **200 °C**
- Punto di scorrimento (ASTM D 97): **-40 °C**

DESCRIPTION

Automatic Transmission Fluid power steering of cars commercial and industrial vehicles and for hydrostatic drives.

Formulated with components that confer the peculiar properties required by the GM specification Dexron II D as regards high corrosion resistance excellent sliding at a low temperature high viscosity index antiwear protection and appropriate frictional characteristics necessary for soft and silent shifts transmissions and longer life of the mechanical components.

As for the replacement it is always recommended to follow the manufacturer's directions.

In general be replaced after 40,000 km on vehicles once a year in industrial vehicles and after 800-1000 hours of work in the agricultural and construction equipment.

CONSTRUCTION

- Colour: **Red.**
- Density at 15 °C (ASTM D 1298): **kg / m³ 870.**
- Viscosity at 100 °C (ASTM D 445): **mm² / s 7,5.**
- Viscosity at 40 °C (ASTM D 445): **mm² / s 36.**
- Viscosity Index (ASTM D 2270): **160.**
- Inflammability point, C.O.C. (ASTM D 92): **200 °C.**
- Pour point (ASTM D 97): **-40 °C.**



Fusto Drum	Olio ROSSO ATF DEXRON II D ATF DEXRON II D Red Oil	
lt	Codice / Part. nr.	
20	●	996 212 020

DESCRIZIONE

Assorbente professionale a base di sepiolite di alta purezza. Ideale per assorbire liquidi di tutti i tipi come olio, benzina, acqua, ecc.



Contenuto Contents	Polvere Assorbilolio a base di Sepiolite Oil Absorbent Powder	
lt	Codice / Part. nr.	
10	●	010 200 006

DESCRIPTION

Professional absorbent based on high purity sepiolite. Ideal for absorbing liquids of all types as oil gasoline water etc.

PANNI ASSORBIOLIO

DESCRIZIONE

Panni **DOBPIO STRATO** ideali per assorbire petrolio, idrocarburi e liquidi oleosi. Assorbenza fino a 20 volte il loro peso.

DESCRIPTION

DOUBLE LAYER Mats ideal for absorbing oil hydrocarbons and oily liquids. Absorbency up to 20 times their weight.



Colore Colour	Misura Measure	Conf. Box	Polvere Assorbilolio a base di Sepiolite Oil Absorbent Powder
	mm	pz./pcs	Codice / Part. nr.
Bianco / White	40 x 50	100	010 200 007

● Fornibile in 7 gg lavorativi / Available in 7 working days

DESCRIZIONE

Kit molto efficace per la rimozione rapida delle macchie d'olio idraulico e petrolio dovute a perdite e fuoriuscite improvvise. Nella maggior parte dei casi l'intervento dei Vigili Del Fuoco può essere evitato, riducendo tutti i costi che ne derivano. Particolarmente consigliato da tenere sempre a portata di mano sui veicoli di assistenza mobile. Grani e panni assorbilolio garantiscono un assorbimento immediato ad alta capacità delle macchie di olio idraulico e petrolio. Con il vostro pronto intervento darete un contributo attivo alla tutela dell'ambiente ed allo stesso tempo eviterete serie ed onerose verbalizzazioni da parte delle Autorità competenti.

CARATTERISTICHE

- Kg 5 Grani Assorbilolio (sepiolite);
- nr. 5 Panni Assorbilolio;
- nr. 1 Telo Antisporco;
- nr. 1 Guanti Protezione Chimica;
- nr. 1 Spazzole Recupero Sporco;
- nr. 1 Paletta Raccogli Sporco;
- nr. 2 Sacchi Spessorati Smaltimento;
- nr. 1 Sgrassante da 50 ml.

DESCRIPTION

Very effective kit for the rapid removal of hydraulic oil stains and petroleum due to losses and sudden spills. In most cases the intervention of the Firefighters can be avoided by reducing all the costs involved. Especially recommended to always keep on hand on the mobile service vehicles. Grains and absorbent mats guarantee an immediate absorption of high-capacity hydraulic oil and oil stains. With your emergency you will give an active contribution to environmental protection and at the same time avoid serious and costly verbalizations by the competent Authority

CONSTRUCTION

- Kg 5 Absorbent Grains;
- nr. 5 Absorbent Mats;
- nr. 1 Anti-Dirty Cloth;
- nr. 1 Chemical Protection Gloves;
- nr. 1 Dirty Recovery Brushes;
- nr. 1 Collect Dirty Shovel;
- nr. 2 Thickened Disposal Sacks;
- nr. 1 Degreaser 50 ml.



KIT SOS

Codice / Part. nr.
010 400 001



● Fornibile in 7 gg lavorativi / Available in 7 working days



FOCUS SETTORIALI
SECTORIAL FOCUS

ARIA COMPRESSA CANTIERI
COMPRESSED AIR
CONSTRUCTION SITES

IDONEO ANCHE PER ACQUA / Suitable for Water



IMPIEGO

Tubo in gomma long length idoneo per mandata di aria compressa e fluidi inerti.

- Temperatura: -30°C +80°C

STRUTTURA

- Sottostrato: liscio in gomma nera SBR.
- Rinforzi: inserzioni di filati sintetici ad alta resistenza.
- Copertura: in gomma nera SBR/EPDM resistente all'abrasione e agli agenti atmosferici.
- Superficie: liscia estrusa.

Disponibile su richiesta: **TAGLIO A MISURA**

APPLICATION

Long length rubber hose suitable for delivery of compressed air and non corrosive fluids.

- Temperature range: -30°C +80°C

CONSTRUCTION

- Tube: black, smooth SBR rubber.
- Reinforcement: high strength synthetic textile yarn.
- Cover: black, abrasion and weathering resistant SBR/EPDM rubber.
- Surface: smooth extruded.

Available on request: **CUT TO LENGTH**

Codice Part Number	Diametro Interno Inside Diameter			Ø Esterno O.D.	Pr. Esercizio Max WP	Pr. Scoppio Burst Pr.	Raggio Curv. Bend Radius	Peso Weight	Lunghezza Length
	DN	Inch	mm						
100 360 614	6	1/4"	6	14	20	60	40	0,15	25 - 100
100 360 817	8	5/16"	8	17	20	60	55	0,22	25 - 100
100 361 019	10	3/8"	10	19	20	60	70	0,25	25 - 100
100 361 323	12	1/2"	13	23	20	60	90	0,34	25 - 100
100 361 626	16	5/8"	16	26	20	60	110	0,40	25 - 80
100 361 930	19	3/4"	19	30	20	60	135	0,51	25 - 50
100 362 537	25	1"	25	37	20	60	175	0,88	25 - 50



IMPIEGO

Tubo in gomma cord idoneo per aria compressa per **impieghi gravosi**.

- Temperatura: -30°C +80°C

STRUTTURA

- Sottostrato: liscio in gomma nera SBR resistente a tracce di olii nebulizzati.
- Rinforzi: tessuti sintetici ad alta resistenza.
- Copertura: in gomma nera SBR/EPDM resistente all'abrasione e agli agenti atmosferici.
- Superficie: liscia ad impressione tela.

APPLICATION

Softwall rubber hose **heavy duty** air compressed delivery.

- Temperature range: -30°C +80°C

CONSTRUCTION

- Tube: black, smooth SBR rubber oil mist resistant.
- Reinforcement: high strength synthetic textile plies.
- Cover: black, abrasion and weathering resistant SBR/EPDM rubber.
- Surface: smooth fabric finished.

Codice Part Number	Diametro Interno Inside Diameter			Ø Esterno O.D.	Pr. Esercizio Max WP	Pr. Scoppio Burst Pr.	Peso Weight	Lunghezza Length
	DN	Inch	mm					
100 381 932	19	3/4"	19	32	25	75	0,71	40
100 382 539	25	1"	25	39	25	75	0,94	40
100 383 248	32	1.1/4"	32	48	25	75	1,43	40
100 383 854	38	1.1/2"	38	54	25	75	1,65	40
100 385 169	50	2"	51	69	25	75	2,45	40
100 386 083	60	2.3/8"	60	83	25	75	3,40	40





IMPIEGO

Tubo **appiattibile** particolarmente leggero per mandata di aria compressa, resistente alle tracce di olio nebulizzato.

- Temperatura: -20 °C +80 °C

STRUTTURA

- Sottostrato: **giallo** liscio in **gomma** nitrilica.
- Rinforzi: inserzioni tessili ad alta tenacità.
- Copertura: gomma sintetica resistente alle intemperie, all'ozono ed all'abrasione.
- Superficie: **gialla liscia con nervatura longitudinale**.

APPLICATION

Light weight, **layflat** compressed air hose, oil mist resistant.

- Temperature range: -20 °C +80 °C

CONSTRUCTION

- Tube: **yellow** nitrile **rubber** tube.
- Reinforcement: high strength textile.
- Cover: synthetic rubber weather, ozone and abrasion resistant.
- Surface: **smooth ribbed yellow**.



Codice Part Number	Diametro Interno Inside Diameter			Pr. Esercizio Max WP	Pr. Scoppio Burst Pr.	Peso Weight	Lunghezza Length
	DN	Inch	mm				
100 381 900	19	3/4"	19	20	75	0,15	60
100 382 500	25	1"	25	20	75	0,21	60
100 383 800	38	1.1/2"	38	20	60	0,44	60
100 385 100	50	2"	51	20	51	0,65	60

• Fornibile in 7 gg lavorativi / Available in 7 working days



Tubo Ø int. x Ø est. Hose Ø int. x Ø ext.	Conf. Box	Morsetto Hercules Hercules Clamp	Morsetto Hercules con Griffe Hercules Clamp with Griffe
mm	pz./pcs	Codice / Part. nr.	Codice / Part. nr.
20x27	10		• 014 002 027
22x29	10	• 014 002 229	
28x35	10	• 014 002 835	
31x33	10		• 014 003 133
32x40	10	• 014 003 240	
35x42	10		• 014 003 542
39x49	10	• 014 003 949	
42x45	10		• 014 004 245
45x53	10		• 014 004 553
48x60	10	• 014 004 860	
55x60	10		• 014 005 560
60x73	10		• 014 006 073
60x76	10	• 014 006 076	
77x94	10	• 014 007 794	
94x115	10	• 014 094 115	
107x127	10	• 014 107 127	
115x145	10	• 014 115 145	

MORSETTI STRINGITUBO



Tubo Ø esterno max Ø external max Hose	Ø Fune Ø Rope	Lunghezza Ingombro Encumbrance Length	Resistenza a Trazione Traction Resistance	Conf. Box	Bloccaggio di Sicurezza Security Clamp
mm	mm	mm	kN	pz./pcs	Codice / Part. nr.
80	3	550	> 5	10	• 240 400 550
180	6	950	> 15	10	• 240 400 950

• Fornibile in 7 gg lavorativi / Available in 7 working days

RACCORDI TURNEXP



Tubo Hose		Filetto Thread	Conf. Box		Raccordo Turnexp Turnexp Fitting	Raccordo Turnexp con Galletto Wing Turnexp Fitting
DN	Inch	Inch	pz./pcs		Codice / Part. nr.	Codice / Part. nr.
13	1/2"	3/4"	5	●	230 000 812	
16	5/8"	3/4"	1	●	230 001 012	
19	3/4"	3/4"	1	●	230 001 212	● 230 101 212
25	1"	1"	1	●	230 001 616	● 230 101 616
32	1.1/4"	1.1/4"	1	●	230 002 020	
38	1.1/2"	1.1/2"	1	●	230 002 424	
50	2"	2"	1	●	230 003 232	
65	2.9/16"	2.1/2"	1			● 230 104 040
75	3"	2.1/2"	1			● 230 104 848
80	3.5/32"	3"	1			● 230 108 048
100	4"	4"	1			● 230 111 064

RACCORDI REPAREX



Tubo 1 Hose 1		Tubo 2 Hose 2		Conf. Box		Raccordo Giunzione Tubo-Tubo Reparex Connection Hose-Hose Fitting
DN	Inch	DN	Inch	pz./pcs		Codice / Part. nr.
13	1/2"	13	1/2"	5	●	230 000 008
16	5/8"	16	5/8"	5	●	230 000 010
19	3/4"	19	3/4"	1	●	230 000 012
25	1"	25	1"	1	●	230 000 016
32	1.1/4"	32	1.1/4"	1	●	230 000 020
38	1.1/2"	38	1.1/2"	1	●	230 000 024
50	2"	50	2"	1	●	230 000 032
65	2.9/16"	65	2.9/16"	1	●	230 000 040
75	3"	75	3"	1	●	230 000 048
80	3.5/32"	80	3.5/32"	1	●	230 000 064

● Fornibile in 7 gg lavorativi / Available in 7 working days

RACCORDI EXPRESS



Tubo Hose		Raccordo Express Express Fitting	Conf. Box		Raccordo Express Express Fitting	Guarnizione Gomma Rubber Seal
DN	Inch	Inch	pz./pcs		Codice / Part. nr.	Codice / Part. nr.
13	1/2"	3/4"	10	●	240 000 808	240 300 012
16	5/8"	3/4"	10	●	240 001 010	
19	3/4"	3/4"	10	●	240 001 212	
25	1"	3/4"	10	●	240 001 616	

ADATTATORI EXPRESS



Raccordo Express Express Fitting	Filetto Thread	Conf. Box		Adattatore Maschio Express Male Express Adaptor	Adattatore Femmina Express Female Express Adaptor
Inch	Inch	pz./pcs		Codice / Part. nr.	Codice / Part. nr.
3/4"	1/4"	10	●	240 100 404	● 240 200 404
3/4"	3/8"	10	●	240 100 606	● 240 200 606
3/4"	1/2"	10	●	240 100 808	● 240 200 808
3/4"	3/4"	10	●	240 101 212	● 240 201 212
3/4"	1"	10	●	240 101 616	● 240 201 616
3/4"	1.1/4"	10	●	240 102 020	● 240 202 020

● Fornibile in 7 gg lavorativi / Available in 7 working days



FOCUS SETTORIALI
SECTORIAL FOCUS

SPURGO
SEWER JETTING



IMPIEGO

Tubo in PVC con spirale PVC idoneo per aspirazione e mandata di liquidi nel settore agricolo dove sia richiesta una buona flessibilità. Indicato per spurghi di fognature, pozzi neri e aspirazione liquami su carri botte.

- Temperatura: -25 °C +60 °C

STRUTTURA

- Sottostrato: liscio in PVC grigio superelastico.
- Rinforzi: **spirale di rinforzo esterna in PVC rigido antiurto e anti schiacciamento color verde** inserita nel PVC superelastico speciale.
- Superficie: semi ondulata

APPLICATION

PVC wire PVC hose suitable for suction and delivery of liquids for heavy duty applications where an extremely flexibility is required. Used on tank cars and irrigation equipments.

- Temperature range: -25 °C +60 °C

CONSTRUCTION

- Tube: grey smooth superelastic PVC.
- Reinforcement: **rigid external impact and crush resistant green PVC wire** dipped in the special superelastic PVC.
- Surface: lightly corrugated.



Codice Part Number	Diametro Interno Inside Diameter		Ø Esterno O.D.	Pr. Esercizio Max WP	Pr. Scoppio Burst Pr.	Raggio Curv. Bend Radius	Ø Esterno O.D.	Peso Weight	Lunghezza Lenght
	Inch	mm							
100 188 094	3.5/32"	80	94	3	9	320	0,8	1,85	30 - 50
100 181 116	4"	100/102	116	3	9	400	0,7	2,70	30 - 50



IMPIEGO

Tubo in PVC con spirale PVC idoneo per aspirazione e mandata di liquidi nel settore agricolo dove sia richiesta una buona flessibilità. Indicato per spurghi di fognature, pozzi neri e aspirazione liquami su carri botte.

- Temperatura: -25 °C +60 °C

STRUTTURA

- Sottostrato: liscio in PVC grigio superelastico.
- Rinforzi: **spirale di rinforzo esterna in PVC rigido antiurto e anti schiacciamento colore BLU** inserita nel PVC superelastico speciale.
- Superficie: semi ondulata

APPLICATION

PVC wire PVC hose suitable for suction and delivery of liquids for heavy duty applications where an extremely flexibility is required. Used on tank cars and irrigation equipments.

- Temperature range: -25 °C +60 °C

CONSTRUCTION

- Tube: grey smooth superelastic PVC.
- Reinforcement: **rigid external impact and crush resistant BLUE PVC wire** dipped in the special superelastic PVC.
- Surface: lightly corrugated.



Codice Part Number	Diametro Interno Inside Diameter		Ø Esterno O.D.	Pr. Esercizio Max WP	Pr. Scoppio Burst Pr.	Raggio Curv. Bend Radius	Ø Esterno O.D.	Peso Weight	Lunghezza Lenght
	Inch	mm							
101 188 094	3.5/32"	80	94	3	9	320	0,8	1,85	30 - 50
101 181 116	4"	100/102	116	3	9	400	0,7	2,70	30





IMPIEGO

Tubo in pvc con spirale pvc molto flessibile idoneo per travaso di olii minerali, carburanti e combustibili industriali.

- Temperatura: -10°C +60°C

STRUTTURA

- Sottostrato: liscio in pvc blu plastificato.
- Rinforzi: spirale di rinforzo in pvc rigido antiurto color bianco.
- Copertura: in pvc blu plastificato resistente agli olii, carburanti e a gran parte dei prodotti chimici.
- Superficie: liscia.

APPLICATION

Pvc wire pvc hose very flexible suitable for discharge of mineral oils and fuels.

- Temperature range: -10°C +60°C

CONSTRUCTION

- Tube: smooth blue pvc.
- Reinforcement: impact and crush resistant white pvc wire helix.
- Cover: oils, fuels and most chemicals resistant blue pvc.
- Surface: smooth.



Codice Part Number	Diametro Interno Inside Diameter		Ø Esterno O.D.	Pr. Esercizio Max WP	Raggio Curv. Bend Radius	Ø Esterno O.D.	Peso Weight	Lunghezza Lenght
	Inch	mm	mm	bar	mm	mm	Kg/mt	mt
• 100 088 093	3.5/32"	80	6,5	5	480	0,9	2,200	30
• 100 081 115	4"	100/102	7,5	4	700	0,9	3,300	30



• Fornibile in 7 gg lavorativi / Available in 7 working days



IMPIEGO

Tubo per mandata ed aspirazione di acqua industriale ed altri fluidi non corrosivi.

- Temperatura: -35°C +75°C

STRUTTURA

- Sottostrato: nero liscio in gomma sintetica.
- Rinforzi: inserzioni tessili ad alta tenacità, **spirale acciaio incorporata**.
- Copertura: gomma sintetica resistente alle intemperie, all'ozono ed all'abrasione.
- Superficie: nera ondulata ad impressione di tela.
- **Manicotti all'estremità**
- Lunghezze finali a richiesta.

APPLICATION

Suction and delivery of water, industrial water and non corrosive fluids.

- Temperature range: -35°C +75°C

CONSTRUCTION

- Tube: black, smooth synthetic rubber.
- Reinforcement: **steel wire helix**, high tensile synthetic plies.
- Cover: black, synthetic rubber cover weather, ozone and abrasion resistant.
- Surface: corrugated with textile finish.
- **Soft cuffs at both ends**
- Lenght on request.



Codice Part Number	Diametro Interno Inside Diameter		Ø Esterno O.D.	Pr. Esercizio Max WP	Pr. Scoppio Burst Pr.	Raggio Curv. Bend Radius	Ø Esterno O.D.	Peso Weight	Lunghezza Lenght
	Inch	mm	mm	bar	bar	mm	mm	Kg/mt	mt
• 100 182 150	6"	150	10	10	30	950	0,7	7,00	multipli 2
• 100 182 200	8"	200	10	10	30	1200	0,7	9,50	multipli 2



• Fornibile in 7 gg lavorativi / Available in 7 working days



Tubo Hose		Bocchettone Iron	Conf. Box		Bocchettone Maschio Male Iron	Bocchettone Femmina Female Iron
DN	Inch	mm	pz./pcs		Codice / Part. nr.	Codice / Part. nr.
48	1.7/8"	48	1	●	049 000 048	049 100 048
60	2.3/8"	60	1	●	049 000 060	049 100 060
80	3.5/32"	80	1	●	049 000 080	049 100 080
80	3.5/32"	100	1	●	049 080 100	049 180 100
100	4"	100	1	●	049 000 100	049 100 100
120	4.3/4"	120	1	●	049 000 120	049 100 120
150	6"	150	1	●	049 000 150	049 100 150
200	8"	200	1	●	049 000 200	049 100 200
250	10"	250	1	●	049 000 250	049 100 250
300	12"	300	1	●	049 000 300	049 100 300

GUARNIZIONI PER BOCCHETTONI



Bocchettone Iron	Conf. Box	Guarnizione in Gomma per Bocchettone Iron Rubber seal
mm	pz./pcs	Codice / Part. nr.
50	10	● 049 400 050
60	10	● 049 400 060
80	10	● 049 400 080
100	10	● 049 400 100
120	10	● 049 400 120
150	10	● 049 400 150
200	10	● 049 400 200
250	10	● 049 400 250
300	10	● 049 400 300



Bocchettone Iron	Filetto Thread	Conf. Box	Bocchettone Maschio Filetto Maschio Male Iron Male Thread	Bocchettone Femmina Filetto maschio Female Iron Male Thread
mm	Inch	pz./pcs	Codice / Part. nr.	Codice / Part. nr.
60	2"	1	049 006 032	049 106 032
80	3"	1	049 008 048	049 108 048
100	4"	1	049 010 064	049 110 064
120	5"	1	049 012 080	049 112 080
150	6"	1	049 015 096	049 115 096



Bocchettone Iron	Conf. Box	Bocchettone Tappo Femmina Iron Female Plug	Bocchettone Tappo Maschio Iron Male Plug
mm	pz./pcs	Codice / Part. nr.	Codice / Part. nr.
60	1	049 210 060	
80	1	049 210 080	049 310 080
100	1	049 210 100	049 310 100
120	1	049 210 120	049 310 120
150	1	049 210 150	049 310 150
200	1	049 210 200	049 310 200



Bocchettone Femmina Female Iron	Bocchettone Maschio Male Iron	Conf. Box	Bocchettone Riduzione Femmina/Maschio Female/Male Iron Reducing
Inch	Inch	pz./pcs	Codice / Part. nr.
200	150	1	049 200 150
250	150	1	049 250 150
300	250	1	049 300 250



Larghezza Width		Spessore Thickness		Conf. Box		Nastro di Chiusura in Inox AISI 201 AISI 201 Closure Tape		Sistema di Fissaggio Professionale Professional Fixing system	
Inch	mm	mm	pz./pcs	mt		Codice / Part. nr.		Codice / Part. nr.	
3/8"	9,5	0,64	1	30,5	●	049 500 006	●	049 501 006	
1/2"	12,7	0,76	1	30,5		049 500 008		049 501 008	
5/8"	15,9	0,76	1	30,5	●	049 500 010	●	049 501 010	
3/4"	19,1	0,76	1	30,5	●	049 500 012	●	049 501 012	



Larghezza Nastro Tape Width		Conf. Box		Graffe per Nastro di Chiusura Closure TapeClip	
Inch	mm	pz./pcs		Codice / Part. nr.	
3/8"	9,5	100	●	049 502 006	
1/2"	12,7	100		049 502 008	
5/8"	15,9	100	●	049 502 010	
3/4"	19,1	100	●	049 502 012	



Conf. Box		Utensile di Serraggio Standard Standard Chucking Tool	
pz./pcs		Codice / Part. nr.	
1		049 503 001	

MONTAGGIO

1. Scorrere il nastro dal rotolo. Inserire la graffa nel nastro con le orecchie rivolte verso l'installatore. Inserire l'estremità tonda del nastro dentro la graffa. Cingere l'oggetto e reinserirlo dentro la graffa. Si può rafforzare la tenuta riciclando nuovamente l'oggetto creando un doppio nastro.
2. Inserire il nastro nell'alloggiamento dell'utensile e farlo scorrere. Con il pollice sulla leva del ferma nastro, stringere ruotando la manovella dell'utensile. Quando il nastro termina di scorrere attraverso la graffa, smettere di girare la maniglia.
3. Ruotare l'utensile sulla graffa in senso contrario e ruotare la maniglia di un giro.
4. Azionare la leva per tagliare il nastro. Rimuovere l'utensile. Premere il nastro tagliato tra le orecchie della graffa, poi battere con un martello e piegare le orecchie sul nastro per completare l'assemblaggio.



ASSEMBLY

1. Pull band from roll. Insert buckle on band, ears away from installer. Bend end of band under buckle. Encircle object bringing band through buckle again. You may double wrap for additional radial compression.
2. Insert band in tool nose slot and slide. With thumb on band gripper lever, tighten by turning tool handle. When band ceases moving through buckle, stop turning the handle.
3. Roll tool over buckle while reversing the handle one turn.
4. Pull handle to cut band. Remove the tool. Push band stub between the ears, then hammer completing the assembly.



IMPIEGO

Tubo di mandata per l'uso sui **camion per la pulizia di condotte fognarie**, canali di scolo, per la pulizia dei canali nei settori dell'industria, dell'artigianato e delle infrastrutture. A richiesta si possono montare altri tipi di raccordi oltre quelli standard riportati nella tabella tecnica. Ogni tubazione riporta sulla boccola un numero di identificazione che si riferisce al certificato di collaudo incluso alla consegna. Lo standard qualitativo elevato garantisce una sicurezza ottimale (controllo elettronico permanente del diametro e collaudo idrostatico di ogni lunghezza).

- Temperatura: -35 °C +80 °C

STRUTTURA

- Sottostrato: SBR, nero, liscio.
- Rinforzi: 2 tessili trecciati.
- Copertura: NB/BR nera, efficienza elevata grazie alla copertura altamente resistente all'abrasione e agli agenti atmosferici (Abrasion secondo EN ISO 6945:2000, max. 0,5 g. (100 N)).
- Superficie: liscia riduce la resistenza allo scorrimento, antiscorpo e facile da pulire.
- Pezzature: i tubi vengono forniti in manichette con le seguenti lunghezze già raccordati: 60 - 80 - 100 - 120 - 150 - 180 - 200 mt

APPLICATION

Pressure hose suited for **sewer cleaning vehicles**, for flushing drains and sewers in industry, commerce and infrastructure. Other connections beyond the standard reported in the technique table on request. Every assembly has a unique serial number on the coupling which, refers to the accompanying test certificate. High quality standards ensure maximum safety (each hose is pressure tested and the bore size is continuously checked electronically).

CONSTRUCTION

- Tube: SBR, black, smooth.
- Reinforcement: two textile braid.
- Cover: NR/BR, black, very cost effective due to its highly abrasion and weather resistant cover. (Abrasion according to EN ISO 6945:2000, max 0.5g (100N)).
- Surface: the smooth cover provides a low friction coefficient and is easily cleaned.
- Packing size: the hoses are supplied already assemblies with the following length: 60 - 80 - 100 - 120 - 150 - 180 - 200 mt

Codice Part Number	Diametro Interno Inside Diameter		Ø Esterno O.D.	Pr. Esercizio Max WP bar	Pr. Scoppio Burst Pr. bar	Raggio Curv. Bend Radius mm	Ø Esterno O.D. mm	Peso Weight Kg/mt	Raccordi Fittings	
	DN	Inch								
● 100 980 120	13	1/2"	13,0	6,0	25	250	625	70	0,460	G 1/2"
● 100 980 340	19	3/4"	19,0	6,0	31	250	625	95	0,610	G 3/4"
● 100 980 100	25	1"	25,0	7,0	39	250	625	110	0,860	G 1"
● 100 980 114	32	1.1/4"	32,0	8,0	48	250	625	150	1,270	G 1.1/4"

TUBI ALTA PRESSIONE PER SPURGO SEWER JETTING HIGH PRESSURE HOSES

EN 857 2SC - SMOOTH COVER



IMPIEGO

TUBO ALTA PRESSIONE 2SC per olii idraulici, minerali e "biologici", olii a base poliglicole, acqua, emulsioni olio/acqua.

- Temperatura: -40 °C +100 °C con punte di 120 °C

STRUTTURA

- Sottostrato: liscio in gomma nera sintetica oleoresistente.
- Rinforzi: **2 treccie acciaio alta resistenza.**
- Copertura: **LISCIA** in gomma sintetica con ottima resistenza all'abrasione, olio ed all'invecchiamento.
- Normative: ISO 11237-1 / DIN EN 857 - 2SC
- Omologazione: **BUREAU VERITAS MARINE DIVISION / MSHA.**

N.B. I tubi vengono forniti già assemblati con alle estremità raccordi Femina+Femmina oppure Maschio+ Femmina a scelta.

APPLICATION

HIGH PRESSURE 2SC HOSE for hydraulic mineral and „biological“ oils, polyglycol base oil, water, oil/water emulsions.

- Temperature range: -40 °C +100 °C peak of +120 °C

CONSTRUCTION

- Tube: seamless oil resistant synthetic rubber.
- Reinforcement: **2 high tensile steel wire braids.**
- Cover: oil, weather and abrasion **SMOOTH** resistant synthetic black rubber.
- According to: ISO 11237-1 / DIN EN 857 - 2SC
- Omologation: **BUREAU VERITAS MARINE DIVISION / MSHA.**

N.B. The hoses are supplied assembled with the ends **Femina + Female or Male + Female fittings of your choice.**



Codice Part Number	Diametro Interno Inside Diameter		Ø Esterno O.D.	Pr. Esercizio Max WP	Pr. Scoppio Burst Pr.	Raggio Curv. Bend Radius	Peso Weight	Lunghezza Length	Raccordi Fittings	
	DN	Inch								mm
S100 100 380	10	3/8"	9,5	17,5	330	1320	65	0,420	100	G 3/8"
S100 060 120	12	1/2"	12,7	20,5	276	1104	90	0,520	60	G 1/2"
S100 080 120	12	1/2"	12,7	20,5	276	1104	90	0,520	80	G 1/2"
S100 100 120	12	1/2"	12,7	20,5	276	1104	90	0,520	100	G 1/2"
S100 120 120	12	1/2"	12,7	20,5	276	1104	90	0,520	120	G 1/2"
S100 060 340	19	3/4"	19	27,9	215	860	120	0,800	60	G 3/4"
S100 080 340	19	3/4"	19	27,9	215	860	120	0,800	80	G 3/4"
S100 100 340	19	3/4"	19	27,9	215	860	120	0,800	100	G 3/4"
S100 120 340	19	3/4"	19	27,9	215	860	120	0,800	120	G 3/4"
S100 060 100	25	1"	25,4	36	165	660	150	1,220	60	G 1"
S100 080 100	25	1"	25,4	36	165	660	150	1,220	80	G 1"
S100 100 100	25	1"	25,4	36	165	660	150	1,220	100	G 1"
S100 120 100	25	1"	25,4	36	165	660	150	1,220	120	G 1"

● Fornibile in 7 gg lavorativi / Available in 7 working days

UGELLI STURATUBI DRAIN CLEANING NOZZLE

UGELLI STURATUBI FISSI



INOX AISI 303 STAINLESS STEEL 303



Filetto Thread	Pressione Esercizio Max WP	Fattore Portata Capacity Size	Portata Flow Rate	3 Fori Posteriori 3 Back Holes	3 Fori Posteriori - 1 Foro Frontale 3 Back Holes - 1 Front Hole
Inch	bar	pz./ pcs	lt/min.	Codice / Part. nr.	Codice / Part. nr.
1/8"	350	3	12,7	●	325 120 330 ● 325 120 430
1/4"	350	3	12,7	●	325 121 330 ● 325 121 430
1/8"	350	3	17	●	325 120 340 ● 325 120 440
1/4"	350	3	17	●	325 121 340 ● 325 121 440

UGELLI STURATUBI "VORTEX"

TESTA TONDA CON RETRO GETTI A DOPPIA INCLINAZIONE PER OTTENERE EFFETTO DI SPINTA E LAVAGGIO. IDONEI PER TUBAZIONI VERTICALI E CANALI DI SCOLO CON CURVE A GOMITO
Sewer Cleaning Nozzles For Vertical Pipes And Drains With Elbows



Filetto Thread	Pressione Esercizio Max WP	Portata Flow Rate	Ø Lavoro Ø Working	Inclinazione Getti Jets Angle	Getto Anteriore Front Jet	Dimensioni Ø x L Dimensions Ø x L	Peso Weight	Ugelli "Vortex" Attacco Femmina "Vortex" Nozzle Female Thread
Inch	bar	lt/min.	mm	gradi	mm	mm	gr	Codice / Part. nr.
1/2"	300	80-170	50-100	15°/35°	M6	37x37	175	● 325 552 850

UGELLI STURATUBI "LIVENZA"

TESTA CONICA IDONEI ALLA PULIZIA DI TUBAZIONI VERTICALI O CON LUNGHE PERCORRENZE
Sewer Cleaning For Vertical Pipes Or Long Runs



Filetto Thread	Pressione Esercizio Max WP	Portata Flow Rate	Ø Lavoro Ø Working	Inclinazione Getti Jets Angle	Getto Anteriore Front Jet	n° e tipo di Inserti n° and type of Inserts	Dimensioni Ø x L Dimensions Ø x L	Peso Weight	Ugelli "Livenza" Attacco Femmina "Livenza" Nozzle Female Thread
Inch	bar	lt/min.	mm	gradi	mm	mm	mm	gr	Codice / Part. nr.
1/2"	300	40-170	50-200	20°	1xM6	6xM6	42x51	222	● 325 551 530

● Fornibile in 7 gg lavorativi / Available in 7 working days



CORTI E A TESTA TONDA CON FORTE TRAZIONE IDONEI ALLA PULIZIA DI BREVI E PICCOLI CONDOTTI FOGNIARI E TUBAZIONI VERTICALI E/O CON CURVE

Small And Short Sewer Cleaning Nozzle



Filetto Thread	Pressione Esercizio Max WP	Portata Flow Rate	Ø Lavoro Ø Working	Inclinazione Getti Jets Angle	Getto Anteriore Front Jet	Dimensioni Ø x L Dimensions Ø x L	Peso Weight	Ugelli "Meduna" Attacco Maschio Meduna" Nozzle Male Thread
Inch	bar	lt/min.	mm	gradi	mm	mm	gr	Codice / Part. nr.
1/2"	300	40-170	50-100	25°	M6	25x43	70	325 352 011

CORTI E A TESTA TONDA CON FORTE TRAZIONE IDONEI ALLA PULIZIA DI BREVI E PICCOLI CONDOTTI FOGNIARI E TUBAZIONI VERTICALI E/O CON CURVE

Small And Short Sewer Cleaning Nozzle



Filetto Thread	Pressione Esercizio Max WP	Portata Flow Rate	Ø Lavoro Ø Working	Inclinazione Getti Jets Angle	Getto Anteriore Front Jet	Dimensioni Ø x L Dimensions Ø x L	Peso Weight	Ugelli "Meduna" Attacco Maschio Meduna" Nozzle Male Thread
Inch	bar	lt/min.	mm	gradi	mm	mm	gr	Codice / Part. nr.
1/2"	300	40-170	50-100	25°	M6	25x43	65	325 352 021



FORMA AD UOVO A FORTE TRAZIONE IDONEI PER PASSAGGIO AGEVOLE IN TUBAZIONI CURVE E PER LA PULIZIA GENERALE DELLE CONDUTTURE FOGNARIE

Egg Shape Sewer Cleaning Nozzles For General Cleaning



Filetto Thread	Pressione Esercizio Max WP	Portata Flow Rate	Ø Lavoro Ø Working	Inclinazione Getti Jets Angle	Getto Anteriore Front Jet	Dimensioni Ø x L Dimensions Ø x L	Peso Weight	Ugelli "Arzino" Attacco Maschio "Arzino" Nozzle Male Thread
Inch	bar	lt/min.	mm	gradi	mm	mm	gr	Codice / Part. nr.
1/2"	300	40-170	60-200	35°	6xM6	31x49	100	325 552 906

FORMA AD UOVO A FORTE TRAZIONE IDONEI PER PASSAGGIO AGEVOLE IN TUBAZIONI CURVE E PER LA PULIZIA GENERALE DELLE CONDUTTURE FOGNARIE

Egg Shape Sewer Cleaning Nozzles For General Cleaning



Filetto Thread	Pressione Esercizio Max WP	Portata Flow Rate	Ø Lavoro Ø Working	Inclinazione Getti Jets Angle	Getto Anteriore Front Jet	Dimensioni Ø x L Dimensions Ø x L	Peso Weight	Ugelli "Arzino" Attacco Maschio "Arzino" Nozzle Male Thread
Inch	bar	lt/min.	mm	gradi	mm	mm	gr	Codice / Part. nr.
1/4"	300	25-80	30-80	15°	forato	25x30	50	325 552 600
3/8"	300	38-90	60-120	15°	forato	30x37	100	325 552 700
1/2"	300	40-170	60-200	15°	6xM6	48x60	300	325 552 806
3/4"	300	55-230	100-250	15°	8xM6	58x72	800	325 553 206
1"	300	60-260	150-350	15°	8xM6	69x85	1300	325 553 308
1.1/4"	300	150-400	150-400	15°	8xM10x1	79x95	2000	325 553 408





IMPIEGO

Tubo flessibile in gomma molto compatto. Progettato per applicazioni ove si deve operare in **spazi ristretti e aree spesso inaccessibili** nel campo industriale e civile. Le caratteristiche principali sono: alta flessibilità, raggio di curvatura estremamente stretto e piccolo diametro esterno, resistenza agli impulsi di flessione, attorcigliamento e all'abrasione. È stato progettato per garantire la massima vita senza problemi e per evitare la sostituzione in aree spesso inaccessibili.

- Temperatura: -40 °C +100 °C con punte di 120 °C

STRUTTURA

- Sottostrato: liscio in gomma nitrile resistente all'olio (NBR).
- Rinforzi: **filo d'acciaio ad alta resistenza.**
- Copertura: liscia in **gomma cloroprene (CR)** con ottima resistenza all'espansione, attorcigliamento e all'abrasione.

APPLICATION

Very compact rubber hose. Designed for applications where you have to work in **confined spaces and often inaccessible areas** in the industrial and civil field.

The main features are: high flexibility, extremely tight bending radius and small outside diameter, resistance to flex impulse, kinking and abrasion. It is designed to provide maximum trouble-free life and to avoid replacing in areas often inaccessible.

- Temperature range: -40 °C +100 °C peak of +120 °C

CONSTRUCTION

- Tube: seamless oil resistant Nitrile rubber (NBR).
- Reinforcement: **high tensile steel wire braids.**
- Cover: expansion, kinking and abrasion smooth resistant **chloroprene black rubber (CR).**



Codice Part Number	Diametro Interno Inside Diameter			Ø Esterno O.D.	Pr. Esercizio Max WP	Pr. Scoppio Burst Pr.	Raggio Curv. Bend Radius	Peso Weight	Boccola Corta Short Ferrule	Boccola Std Std Ferrule
	DN	Inch	mm							
100 599 503	5	3/16"	4,8	9,1	120	480	20	0,090	014 750 316	014 700 316
100 599 604	6	1/4"	6,4	11,0	120	480	25	0,120	014 750 140	014 700 140



IMPIEGO

Trafilato in P.T.F.E. trecciato in acciaio inox idoneo per impianti idraulici, circuiti di lubrificazione, passaggio carburanti, sistemi frenanti, aria compressa, gas, prodotti chimici, prodotti alimentari, prodotti farmaceutici e vapori a alta temperatura.

- Temperatura: -60 °C +205 °C/220 °C

STRUTTURA

- Sottostrato: **P.T.F.E.** estruso.
- Rinforzi/Copertura: trecciatura di filo acciaio inox **AISI 304.**
- Superficie: trecciata.

Pezzature: minimo mt 10

APPLICATION

Stainless wire braided one-layer P.T.F.E. hose suitable for hydraulic and lubricant system, fuel, brake system, compressed air, gas, chemical products, alimentary products, pharmaceutical products and steam high temperature delivery.

- Temperature range: -60 °C +205 °C/220 °C

CONSTRUCTION

- Tube: **P.T.F.E.** one-layer.
 - Reinforcement/Cover: stainless **AISI 304** wire braid.
 - Surface: braided.
- Length: minimum mt 10



Codice Part Number	Diametro Interno Inside Diameter			Ø Esterno O.D.	Pr. Esercizio Max WP	Pr. Scoppio Burst Pr.	Raggio Curv. Bend Radius	Peso Weight	Boccola Corta Short Ferrule	Boccola Std Std Ferrule
	DN	Inch	mm							
100 810 507	5	3/16"	4,8	7,6	190	760	50	0,690	014 750 316	014 700 316
100 810 609	6	1/4"	6,35	8,8	180	720	75	0,870	014 750 140	014 700 140





IMPIEGO

Tubo conforme o superiore ai requisiti SAE 100R7 per medie pressioni per applicazioni oleodinamiche con ottima resistenza all'abrasione. Idoneo per fluidi idraulici a base minerale, sintetica o acquosa in sistemi oleodinamici. Adatto a trasmissione idraulica della potenza in macchine agricole e movimento terra e carrelli elevatori. Adatto anche per molti gas industriali (verificare compatibilità). **Approvato da MSHA - Mine Safety and Health Administration - numero IC-305.**

- Temperatura: - 40 °C +100 °C, limitata a +70 °C per aria e fluidi a base acquosa

STRUTTURA

- Sottostrato: elastomero poliestere.
- Rinforzi: **1 o 2 trecce in fibra sintetica.**
- Copertura: poliuretano, nero, microforatura, marcatura ink-jet bianca.
- Normative: SAE 100R7 // EN855-R7 // ISO3949-R7

APPLICATION

Meets or exceeds SAE 100R7 medium pressure hose suitable for hydraulic applications with increased resistance to abrasion. Suitable for use with petroleum, synthetic or water based hydraulic fluids in hydraulic systems. Suitable for general fluid power transmissions like earthmoving, agricultural machinery and forklifts trucks. Also suitable for many industrial gases (check for compatibility). **MSHA - Mine Safety and Health Administration - numero IC-305 approved.**

- Temperature range: -40°C to +100°C, limited to +70°C for air and water based fluids.

CONSTRUCTION

- Tube: polyester elastomer.
- Reinforcement: **1 or 2 braids of synthetic fiber.**
- Cover: polyurethane, black, pinpricked, white ink-jet branding.
- According to: SAE 100R7 // EN855-R7 // ISO3949-R7



Codice Part Number	Diametro Interno Inside Diameter			Ø Esterno O.D.	Pr. Esercizio Max WP	Pr. Scoppio Burst Pr.	Raggio Curv. Bend Radius	Peso Weight	Boccola Corta Short Ferrule	Boccola Std Std Ferrule
	DN	Inch	mm							
100 007 316	5	3/16"	5	9,6	210	840	25	0,060	014 750 316	014 700 316
100 007 140	6	1/4"	6,5	12,2	210	840	35	0,100	014 750 140	014 700 140



Tubo Hose		Boccola Corta Short Ferrule	Boccola Standard Standard Ferrule
DN	Inch	Codice / Part. nr.	Codice / Part. nr.
5	3/16"	014 750 316	014 700 316
6	1/4"	014 750 140	014 700 140

RACCORDI PARTE UGELLO

**FILETTO GAS CILINDRICO
BSP THREAD**



Tubo Hose		Filetto Thread	Maschio Ugelli Nozzle Male
DN	Inch	Inch	Codice / Part. nr.
5	3/16"	G 1/8"-28	259 100 400
6	1/4"	G 1/8"-28	259 100 500
6	1/4"	G 1/4"-19	259 100 600

RACCORDI PARTE NASPO

**FILETTO GAS CILINDRICO
BSP THREAD**



Tubo Hose		Filetto Thread	Femmina DKR DKR Female	Maschio cil. AGR AGR BSP Male
DN	Inch	Inch	Codice / Part. nr.	Codice / Part. nr.
5	3/16"	G 1/4"-19	210 100 304	
6	1/4"	G 1/4"-19	210 100 404	
6	1/4"	G 1/2"-14	210 100 408	200 100 408

GUANTI DA LAVORO



Taglia Size	Lunghezza totale Total length	Guanto in Cloruro di polivinile - PVC, spessore 1 mm. Polyvinil chloride-PVC Glove, material thickness 1 mm.
mm	pz./pcs	Codice / Part. nr.
10	35	699 535 000

Taglia Size	Guanti in cotone Jersey impregnati in NBR, tutti ricoperti Jersey cotton gloves soaked in NBR, all covered
mm	Codice / Part. nr.
10	695 005 015

GUARNIZIONI PER BOCCHETTONI



Taglia Size	Stivale impermeabile anti pioggia giallo in PVC e gomma nitrilica. Soletta con lamina antiforo in acciaio. Puntale in acciaio sagomato. Resistente alle basse temperature. Suola antiscivolo con sagome per canalizzare l'acqua in modo ottimale. Categoria di protezione S5 EN 20345. Altezza stivale 39 cm. Protezione alle caviglie. PVC and nitrile rubber Boot yellow. Stainless steel antifoam soled. Shaped steel tip. Resistant to low temperatures. Slip outs with silhouettes to channel water optimally. Protection class S5 EN 20345. Boot height 39 cm. Ankle protection.
mm	Codice / Part. nr.
39 ●	695 012 039
40 ●	695 012 040
41 ●	695 012 041
42 ●	695 012 042
43 ●	695 012 043
44 ●	695 012 044
45 ●	695 012 045
46 ●	695 012 046

● Fornibile in 7 gg lavorativi / Available in 7 working days



FOCUS SETTORIALI
SECTORIAL FOCUS

CARRELLI ELEVATORI
FORKLIFTS



IMPIEGO

Tubo in **gomma compatto singolo e binato**, ideale per applicazioni dove è vantaggioso avere pressione associata alla linea di ritorno, quali sollevamento a forche, bracci telescopici, stabilizzatori ed avvolgitubi.

Raggi di curvatura estremamente ridotti (meno della metà di SAE 100 R2) e altissima flessibilità (ideale per applicazioni idrauliche con raggio di curvatura ridotto).

- Temperatura: -20 °C +80 °C (aria fino a +70 °C)

STRUTTURA

- Sottostrato: nitrile (NBR).
- Rinforzi: **singola o doppia treccia d'acciaio ad alta resistenza.**
- Copertura: gomma sintetica nera liscia resistente all'abrasione, oli, ozono e agenti atmosferici.

APPLICATION

Rubber single and twin compact hose suitable for applications where it is advantageous to have pressure associated with the return line, such as lift trucks, telescopic arms, stabilizers and hose reels.

Small bending radii (less than half of SAE 100 R2) and high flexibility (ideal for hydraulic applications with reduced bending radii).

- Temperature range: -20 °C +80 °C (air up to +70 °C)

CONSTRUCTION

- Tube: nitrile (NBR).
- Reinforcement: **one or two braid of high tensile steel wire.**
- Cover: weather and abrasion resistant smooth black synthetic rubber.

SINGOLO



Codice Part Number	Diametro Interno Inside Diameter			Ø Esterno O.D.	Pr. Esercizio Max WP	Pr. Scoppio Burst Pr.	Raggio Curv. Bend Radius	Peso Weight	Boccola Ferrule	Lunghezza Lenght
	DN	Inch	mm							
100 137 140	6	1/4"	6,3	11,5	210	840	40	0,180	014 701 140	10-20-40
100 137 516	8	5/16"	7,9	13,6	210	840	40	0,210	014 701 516	10-20-40
100 137 380	10	3/8"	9,5	15,5	210	840	40	0,250	014 701 380	10-20-40

BINATO



Codice Part Number	Diametro Interno Inside Diameter			Ø Esterno O.D.	Pr. Esercizio Max WP	Pr. Scoppio Burst Pr.	Raggio Curv. Bend Radius	Peso Weight	Boccola Ferrule	Lunghezza Lenght
	DN	Inch	mm							
100 337 140	6	1/4"	6,3	25,8	210	840	40	0,340	014 701 140	10-20-40
100 337 516	8	5/16"	7,9	13,6	210	840	40	0,400	014 701 516	10-20-40
100 337 380	10	3/8"	9,5	31,2	210	840	40	0,480	014 701 380	10-20-40

**BINATO
PASSO STRETTO**



Codice Part Number	Diametro Interno Inside Diameter			Ø Esterno O.D.	Pr. Esercizio Max WP	Pr. Scoppio Burst Pr.	Raggio Curv. Bend Radius	Peso Weight	Boccola Ferrule	Lunghezza Lenght
	DN	Inch	mm							
100 237 380	10	3/8"	9,5	30,0	250	1000	40	0,480	014 701 380	10-20-40



- TUBI COMPATTI A LINEA SINGOLA E DOPPIA
- CONDOTTA INTERNA IN NITRILE CHE GARANTISCE MAGGIORE COMPATIBILITA' CON I FLUIDI
- RAGGI DI CURVATURA ESTREMAMENTE RIDOTTI E ALTA FLESSIBILITA'
- PRESSIONE D'ESERCIZIO COSTANTE.

BOCCOLE A PRESSARE



Tubo Hose		Tubo / Hose ELEVATOR
DN	Inch	Codice / Part. nr.
6	1/4"	014 701 140
8	5/16"	014 701 516
10	3/8"	014 701 380

RACCORDI METRICI SEDE 24° TORNITI

**RACCORDI
 SPECIALI
 Special
 Fittings**



Tubo Hose		Filetto Thread	Maschio CEL CEL Male	
DN	Inch	mm	Ø	Codice / Part. nr.
8	5/16"	M 16x1,5	10L	200 415 162
10	3/8"	M 16x1,5	10L	200 416 162
10	3/8"	M 18x1,5	12L	200 416 182
10	3/8"	M 20x1,5	12S	200 516 202



FOCUS SETTORIALI
SECTORIAL FOCUS

OFFICINE TRUCKS
TRUCKS WORKSHOPS



PEZZI DA 1 MT / 1 mt pieces



IMPIEGO

Tubo in gomma cord idoneo per passaggio di acqua calda mista a liquidi antigelo.

- Temperatura: -40° C +120° C

STRUTTURA

- Sottostrato: liscio in gomma nera EPDM resistente al calore.
- Rinforzi: tessuti sintetici ad alta resistenza.
- Copertura: in gomma nera EPDM resistente all'abrasione al calore e all'invecchiamento.
- Superficie: liscia ad impressione tela.
- Normativa: DIN 73411-79.

APPLICATION

Softwall rubber hose suitable for conveying hot water mixed with cooling liquids.

- Temperature range: -40° C +120° C

CONSTRUCTION

- Tube: black, smooth, heat resistant EPDM rubber.
- Reinforcement: high strength synthetic textile plies.
- Cover: black, abrasion, heat and ageing resistant EPDM rubber.
- Surface: smooth fabric finished.
- According to: DIN 73411-79.



Codice Part Number	Diametro Interno Inside Diameter			Ø Esterno O.D.	Pr. Esercizio Max WP	Pr. Scoppio Burst Pr.	Peso Weight	Lunghezza Length
	DN	Inch	mm					
101 251 824	18	23/32"	18	24	4	12	0,28	1
101 251 925	19	3/4"	19	25	4	12	0,29	1
101 252 026	20	25/32"	20	26	4	12	0,30	1
101 252 228	22	7/8"	22	28	4	12	0,33	1
101 252 532	25	1"	25	32	4	12	0,42	1
101 252 836	28	1.3/32"	28	36	4	12	0,46	1
101 253 038	30	1.3/16"	30	38	4	12	0,58	1
101 253 240	32	1.1/4"	32	40	4	12	0,62	1
101 253 543	35	1.3/8"	35	43	4	12	0,67	1
101 253 846	38	1.1/2"	38	46	4	12	0,82	1
101 254 049	40	1.9/16"	40	49	4	12	0,86	1
101 254 251	42	1.21/32"	42	51	4	12	0,90	1
101 254 554	45	1.3/4"	45	54	4	12	1,02	1
101 255 060	50	1.31/32"	50	60	4	12	1,13	1
101 255 565	55	2.5/32"	55	65	4	12	1,32	1
101 256 070	60	2.3/8"	60	70	4	12	1,43	1
101 256 576	65	2.9/16"	65	76	4	12	1,51	1
101 257 081	70	2.3/4"	70	81	4	12	1,75	1
101 257 586	75	2.15/16"	75	86	4	12	1,80	1
101 258 092	80	3.5/32"	80	92	4	12	2,16	1
101 259 102	90	3.17/32"	90	102	4	12	2,41	1
101 251 113	100	3.15/16"	100	113	4	12	2,80	1

• Fornibile in 7 gg lavorativi / Available in 7 working days



IMPIEGO

Tubo in gomma spiralato grecato idoneo per mandata di acqua calda e liquidi antigelo nei sistemi di raffreddamento dei motori.

- Temperatura: -40° C +120° C

STRUTTURA

- Sottostrato: liscio in gomma nera EPDM resistente al calore.
- Rinforzi: spirale metallica incorporata con tessuti sintetici ad alta resistenza.
- Copertura: in gomma nera EPDM resistente al calore e all'invecchiamento.
- Superficie: grecata ad impressione tela.

APPLICATION

Hardwall square corrugated cover rubber hose suitable for conveying hot water and anti-freeze liquids in engine cooling systems.

- Temperature range: -40° C +120° C

CONSTRUCTION

- Tube: black, smooth, heat resistant EPDM rubber.
- Reinforcement: steel wire helix with high strength synthetic textile plies.
- Cover: black, heat and ageing resistant EPDM rubber.
- Surface: square corrugated fabric finished.

SINGOLO

Codice Part Number	Diametro Interno Inside Diameter			Ø Esterno O.D.	Pr. Esercizio Max WP	Pr. Scoppio Burst Pr.	Raggio Curv. Bend Radius	Peso Weight	Lunghezza Length
	DN	Inch	mm						
100 261 625	16	5/8"	16	24	5	15	60	0,45	5 - 20
100 261 928	19	3/4"	19	27	5	15	70	0,50	5 - 20
100 262 029	20	25/32"	20	28	5	15	70	0,52	5 - 20
100 262 533	25	1"	25	33	5	15	85	0,58	5 - 20
100 262 838	28	1.3/32"	28	36	5	15	95	0,64	5 - 20
100 263 040	30	1.3/16"	30	38	5	15	100	0,68	5 - 20
100 263 242	32	1.1/4"	32	42	5	15	105	0,76	5 - 20
100 263 545	35	1.3/8"	35	45	5	15	115	0,84	5 - 20
100 263 848	38	1.1/2"	38	48	5	15	130	0,95	5 - 20
100 264 050	40	1.9/16"	40	50	5	15	135	1,00	5 - 20
100 264 252	42	1.21/32"	42	52	5	15	140	1,18	5 - 20
100 264 555	45	1.3/4"	45	55	5	15	150	1,20	5 - 20
100 265 060	50	1.31/32"	50	61	5	15	165	1,30	5 - 20
100 265 566	55	2.5/32"	55	65	5	15	180	1,50	5 - 20
100 266 071	60	2.3/8"	60	70	5	15	200	1,70	5 - 20

• Fornibile in 7 gg lavorativi / Available in 7 working days Taglio a misura applicato sovrapprezzo di 15,00 euro / Cut to size applied supplement of 15,00 euro

ACQUA CALDA/SILICONE/LISCIO



PEZZI DA 1 a 4 MT / 1 to 4 mt pieces



IMPIEGO

Tubo in silicone con rinforzo in poliestere **utilizzato per sistemi di riscaldamento e refrigerazione**. Adatto per essere utilizzato in tratti dritti che non necessitano di curvatura.

- Temperatura: -60° C +180° C

STRUTTURA

- Sottostrato: silicone VMQ (Vinil methyl Quality) azzurra.
- Rinforzi: 3 rivestimenti in tessuto di poliestere.
- Copertura: liscia in silicone azzurro resistente al calore, all'ozono e agli agenti atmosferici.

APPLICATION

Silicon hose with polyester reinforcement **used for heating and refrigeration systems**.

Suitable to be used in straight sections that do not require bending.

- Temperature range: -60° C +180° C

CONSTRUCTION

- Tube: blue, silicon VMQ.
- Reinforcement: 3 finishes in polyester fabric.
- Cover: blue, smooth, ozone and weathering resistant silicon.



Codice Part Number	Diametro Interno Inside Diameter			Spessore Thickness	Pr. Esercizio Max WP	Pr. Scoppio Burst Pr.	Lunghezza Lenght
	DN	Inch	mm				
• 100 281 626	16	5/8"	16	4,2	8,27	24,80	da 1 a 4
• 100 281 928	19	3/4"	19	4,2	7,27	21,80	da 1 a 4
• 100 282 534	25	1"	25	4,2	5,90	17,70	da 1 a 4
• 100 282 837	28	1.3/32"	28	4,2	5,40	16,20	da 1 a 4
• 100 283 040	30	1.3/16"	30	4,2	5,13	15,40	da 1 a 4
• 100 283 241	32	1.1/4"	32	4,2	4,90	14,70	da 1 a 4
• 100 283 544	35	1.3/8"	35	4,2	4,57	13,70	da 1 a 4
• 100 283 848	38	1.1/2"	38	4,2	4,30	12,90	da 1 a 4
• 100 284 050	40	1.9/16"	40	4,2	4,13	12,40	da 1 a 4
• 100 284 555	45	1.3/4"	45	4,2	3,77	11,3	da 1 a 4
• 100 284 858	48	1.7/8"	48	4,2	3,60	10,80	da 1 a 4
• 100 285 161	50	2"	51	4,2	3,43	10,30	da 1 a 4
• 100 286 070	60	2.3/8"	60	4,2	3,03	9,10	da 1 a 4
• 100 286 575	65	2.9/16"	65	4,2	2,83	8,50	da 1 a 4
• 100 287 080	70	2.3/4"	70	4,2	2,70	8,10	da 1 a 4
• 100 287 686	76	3"	76	4,2	2,50	7,50	da 1 a 4
• 100 288 090	80	3.5/32"	80	4,2	2,30	6,90	da 1 a 4
• 100 289 100	90	3.17/32"	90	4,2	1,90	3,00	da 1 a 4
• 100 281 112	100	4"	100	4,2	1,67	5,00	da 1 a 4

• Fornibile in 7 gg lavorativi / Available in 7 working days



FOCUS SETTORIALI
SECTORIAL FOCUS

CISTERNE CARBURANTE
FUEL TANKTRUCKS

MANICOTTI LISCI ALLE ESTREMITÀ / Soft End



IMPIEGO

Tubo spiralato ondulato, flessibile e leggero, utilizzato nei camion cisterna. Idoneo per aspirazione e mandata di prodotti petroliferi con contenuto aromatico fino al 50%.

- Temperatura: -20° C +70° C

STRUTTURA

- Sottostrato: nero, liscio, in gomma sintetica antistatica.
- Rinforzo: tessuti sintetici ad alta resistenza e spirale d'acciaio incorporata.
- Copertura: ondulata (ad impressione tela), in gomma sintetica resistente agli oli, ai carburanti ed agli agenti atmosferici.

Confezione: **fornito a misura fissa con manicotti lisci alle 2 estremità.**

APPLICATION

hardwall corrugated hose which is flexible and lightweight to be **used on tank trucks** for the suction and discharge of a wide range of petroleum products with up to 50% aromatic content.

- Temperature range: -20° C +70° C

CONSTRUCTION

- Tube: black, smooth, antistatic, synthetic rubber.
 - Reinforcement: high strength synthetic cord and steel helix wire.
 - Cover: corrugated (wrapped finish), synthetic rubber, oil, fuel, and weathering resistant.
- Packaging: **supplied in fixed measure with soft end.**



Codice Part Number	Diametro Interno Inside Diameter			Ø Esterno O.D.	Pr. Esercizio Max WP	Pr. Scoppio Burst Pr.	Raggio Curv. Bend Radius	Peso Weight	Lunghezza Length
	DN	Inch	mm						
101 118 095	80	3.5/32"	80	95	4	12	200	6,25	2,5
102 118 095	80	3.5/32"	80	95	4	12	200	8,75	3,5
103 118 095	80	3.5/32"	80	95	4	12	200	10,00	4
132 118 095	80	3.5/32"	80	95	4	12	200	12,00	4,8
104 118 095	80	3.5/32"	80	95	4	12	200	12,50	5



• Fornibile in 7 gg lavorativi / Available in 7 working days



Intervallo di Serraggio Voltage Range	Morsetti di Serraggio in Alluminio Aluminium Clamps
mm	Codice / Part. nr.
95 - 97	997 001 585

RACCORDI IN OTTONE



Tubo Hose		Raccordo Express Express Fitting	Guarnizione Gomma Rubber Seal
DN	Inch	Codice / Part. nr.	Codice / Part. nr.
80		997 001 586	997 001 587



• Fornibile in 7 gg lavorativi / Available in 7 working days



Larghezza Width		Spessore Thickness		Conf. Box		Nastro di Chiusura in Inox AISI 201 AISI 201 Closure Tape		Sistema di Fissaggio Professionale Professional Fixing system	
Inch	mm	mm	pz./pcs	mt		Codice / Part. nr.		Codice / Part. nr.	
3/8"	9,5	0,64	1	30,5	●	049 500 006	●	049 501 006	
1/2"	12,7	0,76	1	30,5		049 500 008		049 501 008	
5/8"	15,9	0,76	1	30,5	●	049 500 010	●	049 501 010	
3/4"	19,1	0,76	1	30,5	●	049 500 012	●	049 501 012	



Larghezza Nastro Width		Conf. Box		Graffe per Nastro di Chiusura Closure Tape Clip	
Inch	mm	pz./pcs		Codice / Part. nr.	
3/8"	9,5	100		049 502 006	
1/2"	12,7	100		049 502 008	
5/8"	15,9	100		049 502 010	
3/4"	19,1	100		049 502 012	



Conf. Box		Utensile di Serraggio Standard Standard Chucking Tool	
pz./pcs		Codice / Part. nr.	
1	●	049 500 006	

MONTAGGIO

1. Scorrere il nastro dal rotolo. Inserire la graffa nel nastro con le orecchie rivolte verso l'installatore. Inserire l'estremità tonda del nastro dentro la graffa. Cingere l'oggetto e reinserirlo dentro la graffa. Si può rafforzare la tenuta riciclando nuovamente l'oggetto creando un doppio nastro.
2. Inserire il nastro nell'alloggiamento dell'utensile e farlo scorrere. Con il pollice sulla leva del ferma nastro, stringere ruotando la manovella dell'utensile. Quando il nastro termina di scorrere attraverso la graffa, smettere di girare la maniglia.
3. Ruotare l'utensile sulla graffa in senso contrario e ruotare la maniglia di un giro.
4. Azionare la leva per tagliare il nastro. Rimuovere l'utensile. Premere il nastro tagliato tra le orecchie della graffa, poi battere con un martello e piegare le orecchie sul nastro per completare l'assemblaggio.



ASSEMBLY

1. Pull band from roll. Insert buckle on band, ears away from installer. Bend end of band under buckle. Encircle object bringing band through buckle again. You may double wrap for additional radial compression.
2. Insert band in tool nose slot and slide. With thumb on band gripper lever, tighten by turning tool handle. When band ceases moving through buckle, stop turning the handle.
3. Roll tool over buckle while reversing the handle one turn.
4. Pull handle to cut band. Remove the tool. Push band stub between the ears, then hammer completing the assembly.



Taglia Size		Lunghezza totale Total length		Guanto in Cloruro di polivinile - PVC, spessore 1 mm. Polyvinil chloride-PVC Glove, material thickness 1 mm.	
mm		pz./pcs		Codice / Part. nr.	
10		35		699 535 000	

Taglia Size		Guanti in cotone Jersey impregnati in NBR, tutti ricoperti Jersey cotton gloves soaked in NBR, all covered	
mm		Codice / Part. nr.	
10		695 005 015	

STIVALI DA LAVORO



Stivale impermeabile anti-pioggia giallo in PVC e gomma nitrilica. Soletta con lamina antiforo in acciaio. Puntale in acciaio sagomato. Resistente alle basse temperature.

Suola antiscivolo con sagome per canalizzare l'acqua in modo ottimale. Categoria di protezione S5 EN 20345. Altezza stivale 39 cm. Protezione alle caviglie. PVC and nitrile rubber Boot yellow. Stainless steel antifoam soled. Shaped steel tip. Resistant to low temperatures. Slip outs with silhouettes to channel water optimally. Protection class S5 EN 20345. Boot height 39 cm. Ankle protection.

Taglia Size		Codice / Part. nr.	
mm			
39	●	695 012 039	
40	●	695 012 040	
41	●	695 012 041	
42	●	695 012 042	
43	●	695 012 043	
44	●	695 012 044	
45	●	695 012 045	
46	●	695 012 046	



FOCUS SETTORIALI
SECTORIAL FOCUS

**GUARNIZIONI PER OLEODINAMICA
E PNEUMATICA**
HYDRAULIC & PNEUMATIC SEALS

FORNIBILI A RICHIESTA / Available on Request



GUARNIZIONI

A richiesta possiamo fornire ogni tipo di Guarnizione per Oleodinamica e per Pneumatica. Grazie ad un magazzino di appoggio con oltre 55.000 Guarnizioni a stock, le richieste possono essere evase con tempestività. I prodotti distribuiti garantiscono uno standard di qualità elevato.

SEALS

On request we can supply any type of Hydraulics and Pneumatics seal. Thanks to a stock backed with over 55,000 Seals, the requests may be processed promptly. The products distributed ensure a high quality standard.

OLEODINAMICA / HYDRAULIC

616/M	BUF	CSC	FT	GIP	GIR	GIR D.E.	GT5
GT7	GUA 02	K31	LRC - RC	MA43 Energizzate	PSE	SAM/SAL/EDBRO	TGO
GT7	GUA 02	K31	LRC - RC	MA43 Energizzate	PSE	SAM/SAL/EDBRO	TGO

PNEUMATICA / PNEUMATIC

AIRZET PR	AUDIP	AUNIPSL	DIP	GDI	GDIM	GU	GUM
H	NIPSL	NIPSL 200	NIPSL 210	NIPSL 300	NIPSL 310	NIPSL 320	NIPSL SF

OLEODINAMICA / HYDRAULIC

58	CUT	GER	GER S.E.	GER/T	GT/NWO	GT3	GT5
GT7	GUA01	K20	LRP-RP	MA44	PDE	PDE PD	PDH
PDP	PQ	PSC	TDE	TEOL/2	TGU	TP	TPD/FPW
TPL	TPM	TPM NEO	TPS/G	TPS/T	TRU	TSE/AE	TSE/NEO/KR
TSE/NWO	TSE/NWO/KR	TTD	TTE	TTE/AE/KR	TTE/W	TTO	TTQ
TTU	TTU/O	TTW	ZP/ZC			ANELLI	KR

PNEUMATICA / PNEUMATIC

AIRZET PK	C	FT	GDE	GDEM	GU	GUM	KDN
MPS2	NADUOP	NAP 210	NAP 300	NAP 310	PDEP	TDUOP M	Z5

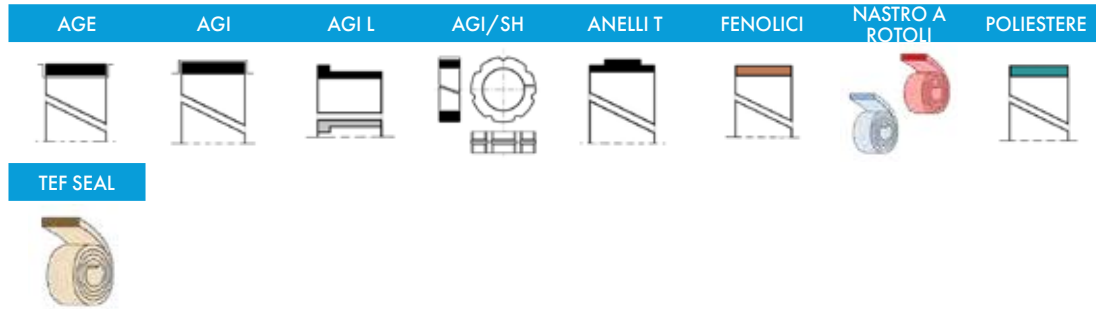

RASCHIATORI / WIPERS

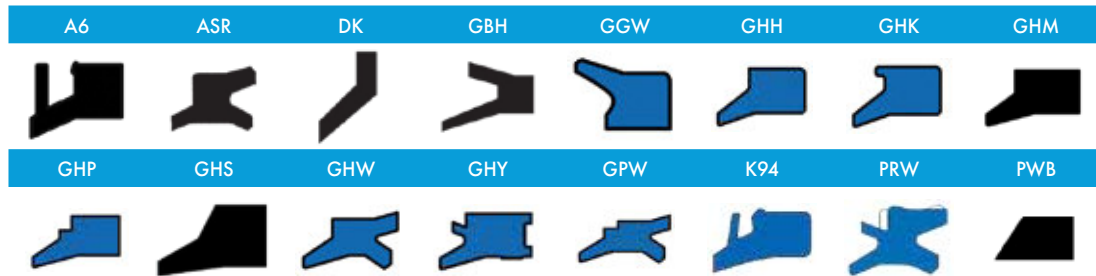

GABBIA METALLICA / METALLIC CAGE



RICOPERTI / COVERED

PTFE + BRONZO / PTFE + BRONZE



PER SFILANTI / TELESCOPIC

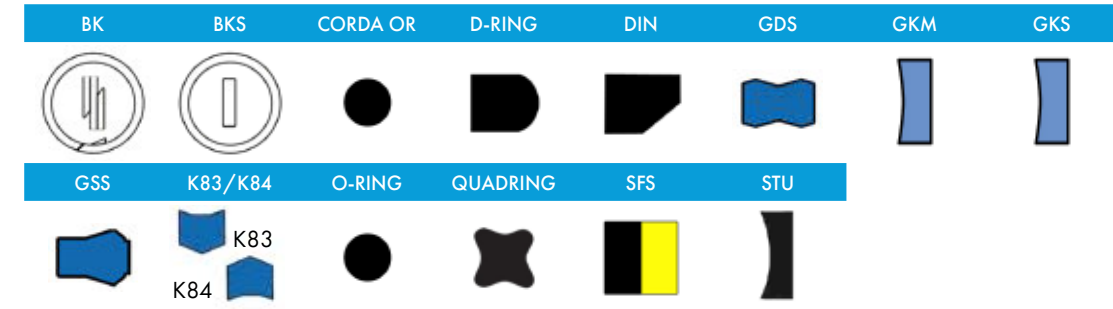

STATICHE - O-RING / STATIC SEALS - O-RING

ROTANTI / ROTARY SHAFT SEALS

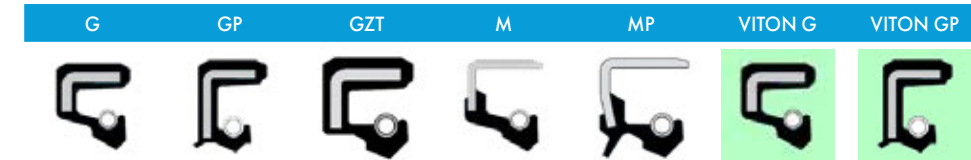

ROTANTI DOPPIA MOLLA / DOUBLE SPRING



PARAGRASSO / GREASE S.



ALTA PRESSIONE / HIGH PRESSURE



SCATOLATI / METAL OUTS.

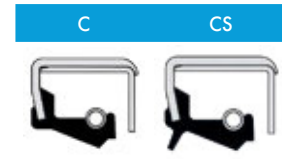

SPECIALI / SPECIALS

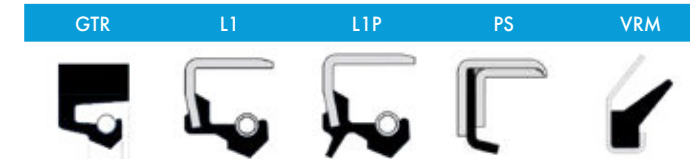

ALTRI / OTHER



NBR (elastomero butadieneacrolonitrile)

- **Durezza:** 70 ÷ 80 ÷ 90 Shore.
- **Temperatura:** -30°C +100°C.
- **Caratteristiche:** resistenza agli oli, grassi minerali e vegetali, alcali, alcoli, gas, acqua, glicol, soluzioni saline, prodotti alimentari; resistenza relativa all'ozono.
- **Campi d'impiego:** costruzioni di macchine in genere, apparecchiature e pompe, dispositivi idraulici e pneumatici.
- **Prodotti:** o-ring, corda per o-ring, kit o-ring, Q-ring.

VITON - FPM (elastomero fluorurato)

- **Durezza:** 70 ÷ 90 Shore.
- **Temperatura:** -15°C +200°C.
- **Caratteristiche:** alta resistenza al calore ed eccezionale resistenza agli agenti chimici: oli, idrocarburi alifatici, diversi fluidi idraulici ininfiammabili.
- **Campi d'impiego:** costruzioni di apparecchiature chimiche di pompa per vuoto spinto, attrezzature idrauliche con fluidi ininfiammabili.
- **Prodotti:** o-ring, corda per o-ring, kit o-ring.

SILICONE (elastomero silicone)

- **Durezza:** 60 ÷ 80 Shore.
- **Temperatura:** -60°C +200°C.
- **Caratteristiche:** ampio campo di temperature; compatibilità con gli alimenti scarsa resistenza all'abrasione.
- **Campi d'impiego:** costruzioni di apparecchiature chimiche e macchine per industria alimentare.
- **Prodotti:** o-ring, corda per o-ring.

EPDM (elast. etilenepropilene reticolato)

- **Durezza:** 70 Shore.
- **Temperatura:** -40°C +160°C.
- **Caratteristiche:** buona resistenza all'acqua calda e vapore, all'invecchiamento ed agli agenti atmosferici. Non resistente agli oli ed ai grassi minerali.
- **Campi d'impiego:** rubinetteria per sanitari e riscaldamento, pompe, apparecchiature nucleari.
- **Prodotti:** o-ring, corda per o-ring.

CR 70 CR (elast. cloroprene, neoprene)

- **Durezza:** 70 Shore.
- **Temperatura:** -40°C +100°C.
- **Caratteristiche:** resistente agli agenti atmosferici ed all'invecchiamento, agli alcali, alcool, grassi, glicol, ozono e ai prodotti refrigeranti.
- **Campi d'impiego:** compressori frigoriferi e in condizioni atmosferiche.
- **Prodotti:** o-ring, corda per o-ring.

NBR (elastomer butadieneacrolonitrile)

- **Durometer:** 70 ÷ 80 ÷ 90 Shore.
- **Temperature range:** -30°C +100°C.
- **Main features:** resistance to the oils, mineral and vegetable fats, alkali, alcohol, gas, water, glycol, saline solutions, food products; resistance relative to the ozone.
- **Applications:** machines constructions generally, equipment and pumps, hydraulic and pneumatic devices.
- **Products:** o-ring, o-ring cord, kit o-ring, Q-ring.

VITON - FPM (elastomer fluorinated)

- **Durometer:** 70 ÷ 90 Shore.
- **Temperature range:** -15°C +200°C.
- **Main features:** high resistance to the heat and exceptional resistance to the chemical agents: oils, aliphatic hydrocarbons, unflammable hydraulic fluids.
- **Applications:** constructions of chemical equipment of pump for pushed gap, hydraulic equipment with unflammable fluids.
- **Products:** o-ring, o-ring cord, kit o-ring.

SILICONE (elastomer silicone)

- **Durometer:** 60 ÷ 80 Shore.
- **Temperature range:** -60°C +200°C.
- **Main features:** wide temperatures field; compatibility with the foods, resistance limited to the abrasion.
- **Applications:** constructions of chemical equipment and machines for alimentary industry.
- **Products:** o-ring, o-ring cord.

EPDM (elast. netting ethylenepropylene)

- **Durometer:** 70 Shore.
- **Temperature range:** -40°C +160°C.
- **Main features:** good resistance to the hot water and vapour, to the ageing and to atmospheric agents. Not resisting the oils and the mineral fats.
- **Applications:** taps and fittings for physicians and heating, pumps, nuclear equipment.
- **Products:** o-ring, o-ring cord.

CR 70 CR (elast. chloroprene, neoprene)

- **Durometer:** 70 Shore.
- **Temperature range:** -40°C +100°C.
- **Main features:** resisting the atmospheric agents and the ageing, the alkalis, alcohol, fats, glycol, ozone and to the refrigerant products.
- **Applications:** refrigerant compressors and in atmospheric conditions.
- **Products:** o-ring, o-ring cord.



FOCUS SETTORIALI
SECTORIAL FOCUS

MACCHINARI
EQUIPMENTS

**MACCHINARI PER TUBO FLESSIBILE & TUBO RIGIDO
FLEXIBLE HOSE & RIGID PIPE MACHINERY**

Se desiderate attrezzare un centro di raccordatura o implementare le macchine in vostro possesso, noi vi proponiamo le soluzioni adeguate alle vostre esigenze. Una vasta gamma di macchinari per la raccordatura, taglio, spellatura e stoccaggio dei tubi flessibili; per la svasatura, curvatura, premontaggio e sbavatura dei tubi rigidi; per la pulizia di entrambi. La gamma dei prodotti è completata da un'assistenza ed un supporto tecnico a vostra disposizione ove si ritenesse necessario.

Richiedete un'offerta mirata per ogni vostra esigenza, sarà nostra premura offrirvi quanto di vostro interesse con scheda tecnica dettagliata.

Con HSR sarete ben attrezzati ed istruiti per accontentare i vostri clienti per ogni necessità.

If you wish to equipping a crimping center or implementing the machines in your possession, we offer you solutions tailored to your needs. A wide range of machinery for crimping, cutting, skiving and storage of flexible hoses; flaring, bending, deburring and pre-assembly of rigid pipes; for the cleaning of both. The product range is completed with assistance and technical support available to you if it were considered necessary. Require an offer targeted to your needs, we will offer you what of interest to you with a detailed specification data sheet.

With HSR will be well equipped and instructed to satisfy your customers for any needs.

TUBO FLESSIBILE / FLEXIBLE HOSE

PRESSE AGGRAFFATUBI / CRIMPING MACHINE



TUBO FLESSIBILE / FLEXIBLE HOSE

TAGLIERINE / CUTTING MACHINE



SPELLATUBI / SKIVING MACHINE



MARCATORI / MARKERS



PULIZIA / CLEANING

INSERIMENTO / INSERTION



TAGLIERINE / CUTTING MACHINE



COLLAUDO / TESTING



CURVATURA / BENDING



SVASATURA / FLARING



PREMONTAGGIO / PRE-ASSEMBLING



SBAVATURA / DEBURRING



PULIZIA / CLEANING





FOCUS SETTORIALI
SECTORIAL FOCUS

APPENDICE TECNICA
TECHNICAL APPENDIX

RACCOMANDAZIONI GENERALI SULL'IMPIEGO DEI TUBI FLESSIBILI

Selezione, Installazione e Manutenzione dei Tubi Flessibili e dei Tubi Flessibili Raccordati

Stralcio Dalla Norma Sae 11273 Agosto 2004

1. SCOPO.

La vita dei tubi flessibili (e dei i tubi flessibili assemblati) è condizionata da numerosi fattori che ne riducono la durata. Queste raccomandazioni emesse dalla SAE, vogliono essere una guida di base per i vari progettisti od utilizzatori, nella selezione, installazione e manutenzione dei vari tipi di tubi flessibili. Progettisti ed utilizzatori, devono effettuare periodicamente verifiche di compatibilità per ogni tipo di applicazione e successivamente selezionare, installare e mantenere efficienti i tubi flessibili secondale indicazioni delle presenti RACCOMANDAZIONI GENERALI.

2. RIFERIMENTI.

2.1 - Documenti di riferimento.

Le norme che seguono in questa pubblicazione, formano parte integrante di questo documento. Dove non specificato dettagliatamente, il documento di riferimento sarà sempre e comunque rappresentato dall'ultima edizione della normativa SAE.

2.1.1 - Norme SAE.

Le normative SAE da cui queste raccomandazioni sono tratte, sono:
SAE J343 - metodologie di prove per tubi e tubi raccordati SAE 100R..
SAE J514 - Raccordi idraulici da tubo
SAE J517 - Tubi idraulici
SAE J1927 - Analisi cumulative dei danni nei tubi flessibili.

2.1.2 - Norme ISO.

Le normative ISO da cui queste raccomandazioni sono tratte, sono:
ISO 3457 - macchine movimento terra, isolamenti e protezioni - Definizioni e requisiti.

3. CONSIDERAZIONI SULLA SICUREZZA.

Di seguito, alcune potenziali situazioni/condizioni che possono essere fonte di danni a persone o cose. Ovviamente questa lista non può prevedere tutte le possibili condizioni, ma vuole essere un documento base per prevenire ed eliminare possibili rischi ed incidenti.

3.1 - Contatto con carburanti pressurizzati e fluidi vari.

Carburante in pressione nebulizzato, può penetrare nella pelle e nel corpo umano, causando severi danni al tessuto cutaneo. Si dovrà quindi considerare attentamente il rischio derivante da tali situazioni, valutando opportunamente come collegare il tubo flessibile, verificare la non interferenza con altri elementi vicini, adottando adeguate protezioni, barriere e, soprattutto, facendo un'adeguata sensibilizzazione al personale addetto al montaggio. Eseguire sempre un rilevamento della pressione prima di disconnettere ogni qualsiasi tipo di linea (idraulica od altro). Serrare correttamente tutta la raccorderai, prima di immettere pressione nel circuito. Cercare di evitare il contatto con i fluidi trasmessi nel circuito. Considerare che ogni tipo di perdita (pressurizzata o no) può causare seri danni alla pelle e, soprattutto, non utilizzare nessuna parte del corpo per verificare se ci sono perdite da un collegamento. Nel caso si verificasse un'esposizione ad un getto di carburante, non trattare il problema come se fosse un semplice taglio, ma consultare immediatamente un medico. Ogni penetrazione di carburante nella pelle deve essere rimossa chirurgicamente entro poche ore dall'accaduto, per non generare rischi di cancrena.

3.2 - Colpi di frusta.

In caso di scoppio e rottura di un tubo flessibile raccordato, i raccordi si possono sfilare ed essere lanciati a forte velocità, mentre il tubo può fluttuare o generare dei colpi di frusta. In caso che ciò si possa effettivamente verificare, considerare idonei strumenti di ritenzione idonei per il tubo raccordato.

3.3 - Rischi di ustioni da fluidi.

I fluidi utilizzati nei vari circuiti, possono raggiungere temperature che possono ustionare facilmente la pelle umana. In queste situazioni (e soprattutto nella zona dell'operatore), è necessario proteggere sempre il tubo raccordato con dispositivi che prevenegano danni all'operatore stesso.

3.4 - Incendi od esplosioni.

In certe condizioni, i fluidi impiegati nei vari impianti (compresi i fluidi resistenti al fuoco), possono incendiarsi. In caso di perdite in pressione, si possono formare nebulizzazioni che sono facilmente infiammabili quando in contatto con fonti di calore.

Selezionare, installare e proteggere sempre il tubo raccordato per mantenere basso il rischio di incendio (fare riferimento alla sezione 5 della ISO 3457).

3.5 - Incendi od esplosioni per scariche elettriche.

I fluidi in pressione trasportati all'interno dei tubi flessibili, generano un accumulo di cariche elettrostatiche che, a loro volta, si trasformano in scintille e possono incendiare (in caso di perdite) il fluido od il gas trasportato.

Quando ciò è potenzialmente possibile, selezionare sempre tubi con sottostrato non conduttibile.

3.6 - Shock elettrico.

Nel caso il tubo conduca elettricità attraverso il corpo umano, si può generare elettrococ. La maggior parte dei tubi contengono rinforzi metallici ed i raccordi di estremità sono anch'essi metallici. Anche tubi non conduttibili, possono generare delle scariche elettriche quando trasportano fluidi conduttibili.

Prestare attenzione nell'installare tubi flessibili nella vicinanza di fonti elettriche. Quando ciò non può essere possibile, tenere presente che la norma SAE J517 prevede la gamma SAE 100R7 e SAE 100R8 con copertura arancione/rossa e dicitura "non conduttibile".

3.7 - Dispositivi comandati idraulicamente.

I meccanismi oleodinamici, possono diventare pericolosi in caso di rotture dei tubi flessibili. Ad esempio, in caso di scoppio del tubo, si possono avere cadute di carichi sospesi, perdita di controllo nei dispositivi di guida o nei sistemi frenanti idraulici.

In questi casi sarà necessario adottare opportuni accorgimenti tecnici per prevenire tali non conformità.

4. SELEZIONE ED INSTALLAZIONE DI TUBI FLESSIBILI.

Molti sono i fattori che influenzano la vita dei tubi flessibili e della funzionalità operativa di un impianto idraulico e gli effetti combinati di queste tipologie, sono spesso difficilmente prevedibili.

Questo documento deve quindi essere considerato una guida generale e non può quindi contemplare tutte le tipologie applicative dell'oleodinamica.

Per applicazioni che esulano dalla SAE J517, e dalla SAE J514 o da altri standards internazionali, le caratteristiche dei tubi flessibili, dovranno essere determinate mediante test e prove specifiche.

Considerare attentamente ogni impianto, sia in termini di tipo di tubo, installazione e prevenzione da danni a persone e cose.

Al riguardo, considerare attentamente i seguenti fattori:

4.1 - Pressione.

Pressioni del sistema più elevate, abbreviano notevolmente la vita del tubo flessibile. Analizzare bene le caratteristiche dell'impianto e valutare adeguatamente picchi di pressione e frequenze pulsanti.

Dopo aver determinato la pressione del sistema, la scelta del tubo dovrà essere effettuata in modo tale che la massima pressione di esercizio, risulti essere uguale o superiore a quella del sistema operativo.

La norma SAE J1927, fornisce una metodologia per aiutare a prevedere la riduzione della vita del tubo flessibile in funzione di una specifica applicazione idraulica, soprattutto in funzione dei picchi di pressione e delle frequenze pulsanti.

4.2 - Aspirazione.

Negli impianti di aspirazione (ingresso alla pompa) la scelta del tubo flessibile, deve essere effettuata verificando la resistenza del tubo flessibile al valore di depressione prevista nell'impianto dove verrà applicato.

4.3 - Pressione esterna.

In applicazioni specifiche (come ad esempio all'interno di autoclavi o sott'acqua), la pressione esterna dell'ambiente può essere superiore alla pressione interna dell'impianto e quindi danneggiare od appiattire il tubo.

4.4 - Temperatura.

La temperatura statica e transitoria del sistema non deve mai essere superiore a quella prevista per il tubo flessibile. Adottare particolare attenzione quando i tubi flessibili vengono fatti passare vicino a sorgenti di calore come collettori o manifolds, per non accelerare l'invecchiamento del tubo. Utilizzare sempre sistemi di protezione quali guaine protettive od isolanti, installando il tubo nell'impianto più lontano possibile dalle fonti di calore.

4.5 - Permeabilità.

La permeabilità del fluido attraverso il tubo, dipende molto dalle caratteristiche delle mescole con cui è costruito. Considerare sempre gli effetti della permeabilità, con particolare attenzione quando si tratta di convogliare gas o miscele gassose. In caso di dubbio, consultare sempre il fabbricante del tubo ed il produttore del gas.

4.6 Compatibilità dei materiali.

Tra i molti parametri che possono influenzare la compatibilità tra tubo flessibile e fluido trasportato, dovranno soprattutto essere tenuti in considerazione:

- Pressione del fluido
- Temperatura
- Concentrazione
- Durata del periodo di esposizione Pressione del fluido

Soprattutto a causa della permeabilità, è necessario assicurarsi della compatibilità del fluido, non solo con il sottostrato del tubo flessibile, ma anche con i gli elementi di rinforzo, la copertura ed i raccordi.

Consultare sempre il fabbricante del tubo per ulteriori informazioni.

NOTA: molte caratteristiche di compatibilità dei tubi flessibili ai fluidi trasportati, sono espresse per temperature ambiente attorno ai 21 °C.

Le proprietà dei fluidi possono però cambiare a temperature diverse da quella ambientale. In caso di dubbio, consultare sempre il fabbricante del tubo per ulteriori informazioni.

4.7 Ambiente esterno.

L'ambiente esterno, può creare un degrado sui tubi e sui raccordi. Valutare attentamente alcune tra le condizioni più importanti:

- Luce ultravioletta
- Acqua salata
- Inquinanti atmosferici
- Temperatura
- Ozono
- Prodotti chimici
- Elettricità
- Abrasione

In caso di dubbio, consultare sempre il fabbricante del tubo per ulteriori informazioni.

4.8 - Cariche elettrostatiche.

I fluidi in pressione trasportati all'interno dei tubi flessibili, generano un accumulo di cariche elettrostatiche che, a loro volta, possono perforare il tubo.

Se esiste un tale rischio, è necessario scegliere un tubo con una conducibilità sufficiente a scaricare a terra le cariche elettrostatiche.

4.9 - Dimensionamento.

La potenza trasmessa varia in funzione della portata.

Il tubo deve quindi essere selezionato garantendo il valore minimo delle perdite di carico in funzione della pressione dell'impianto, per non creare problemi di eccessiva velocità del fluido (turbolenze) o surriscaldamenti indesiderati.

4.10 - Utilizzi non previsti.

I tubi flessibili sono progettati per supportare i gradienti interni di pressione.

Non devono quindi essere assoggettati a carichi di trazione o a forze esterne che possano danneggiare anche i raccordi di estremità.

4.11 - Specifiche e Standards.

Nella scelta dei tubi flessibili fare sempre riferimenti a normative o standard internazionali di chiara interpretazione e riferimento.

4.12 - Applicazioni non previste.

Per la scelta del tubo flessibile in casi di applicazioni o caratteristiche non previste, può essere necessari condurre prove supplementari, per valutarne appieno i requisiti operative.

4.13 - Pulizia interna.

I requisiti di non contaminazione dei componenti del sistema, determinano il grado di pulizia interna per l'applicazione specifica.

I tubi flessibili raccordati hanno diversi gradi di pulizia. Nel caso, specificare sempre i valori richiesti per il sistema, o consultare il produttore per informazioni più specifiche.

4.14 - Raccordi di estremità.

Il tubo flessibile deve essere compatibile con il raccordo utilizzato per il collegamento al circuito del sistema.

Seguire scrupolosamente le indicazioni del costruttore, soprattutto se conformi ai requisiti della norma SAE J517.

I raccordi di estremità di un produttore, non sono generalmente compatibili con quelli forniti da un altro produttore (ad esempio inserto di un produttore con boccola di un altro produttore).

E' responsabilità dell'assemblatore consultare il produttore del tubo flessibile per la miglior soluzione nella scelta dell'accoppiamento

tubo/raccordo più idoneo.

Una scelta impropria dell'accoppiamento tubo-raccordo, è la causa principale di perdite o di sfilamenti che possono causare danni a persone o cose, come già più volte sottolineato.

4.15 Vibrazioni.

Anche le vibrazioni possono ridurre la vita del tubo.

Ove necessario, effettuare prove di vibrazione sul tubo, per verificarne ampiezza e frequenza.

Nel caso, utilizzare fascettature od altri sistemi analoghi per ridurre l'effetto.

4.16 Protezione della copertura del tubo.

Proteggere la copertura del tubo per danni derivanti da abrasione, erosione, sfregamenti e tagli.

Installare il tubo flessibile avendo cura di evitare che venga in contatto con altri tubi o con superfici che possano rovinarne la copertura (vedere fig. 1)

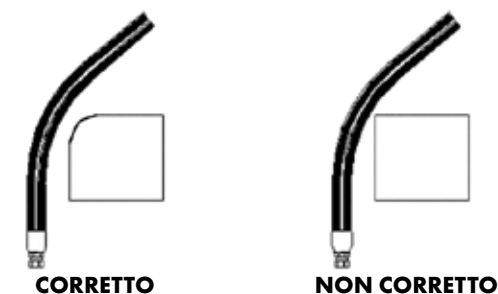

FIG. 1 - PREVENZIONE DANNI ESTERNI SUL TUBO

4.17 - Sollecitazioni fisiche esterne.

Installare il tubo per evitare:

- Sollecitazioni di trazione
- Carichi laterali
- Schiacciamenti
- Danni alle filettature
- Flessioni sotto al minimo raggio di curvatura (kinking)
- Danneggiamenti delle superfici di contatto
- Abrasione
- Torsione

4.18 - Adattatori con dado girevole.

Si devono sempre utilizzare adattatori con dado girevole, perché non trasferiscono effetti di torsione durante il montaggio del tubo flessibile.

4.19 -Giunti girevoli.

Quando due componenti del sistema sono in rotazione reciproca, si dovranno utilizzare giunti girevoli per eliminare ogni effetto di torsione.

4.20 - Guide e fascette.

Utilizzare sempre guide o fascette per sostenere tubi di una certa lunghezza o per evitare che entrino in contatto con parti in movimento o vengano sottoposti a rischi di abrasione.

4.21 - Raggio minimo di curvatura.

Il raggio minimo di curvatura è specificato nella normativa SAE J343.

Installazioni sotto il minimo raggio di curvatura, riducono notevolmente la vita del tubo. Analogamente curvature eccessive nella zona dei raccordi possono portare ad un rapido degrado del tubo e, successivamente allo scoppio.(fig. 2A e 2B)

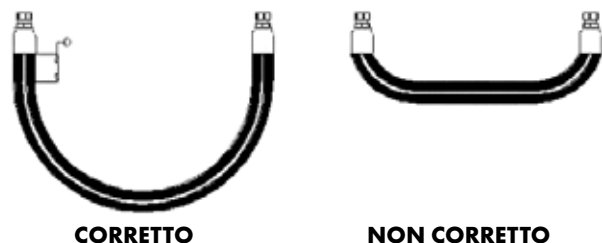

FIG. 2A – RAGGIO DI CURVATURA CORRETTO

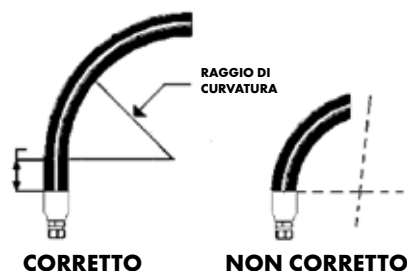

FIG. 2B – RAGGIO DI CURVATURA CORRETTO

4.22 - Curve ed adattatori.

Utilizzare curve od adattatori per togliere sollecitazioni dal tubo (fig. 3)

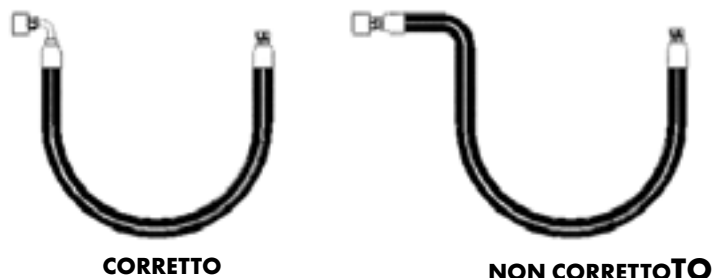

FIG. 3 – CURVE ED ADATTATORI

4.23 - Lunghezza.

Tubi eccessivamente lunghi possono aumentare le perdite di carico ed influiscono sulle prestazioni del sistema.

Tubi troppo corti possono causare problemi di trazione sui raccordi, quando pressurizzati alla pressione operativa del sistema. Nello stabilire la lunghezza dei tubi, tenere in considerazione gli schemi delle fig. 4,5 e 6, utilizzando i seguenti suggerimenti.

4.23.1 Assorbimento del movimento.

La lunghezza del tubo deve essere tale da assecondare il moto ed evitare di portarsi al di sotto del minimo raggio di curvatura

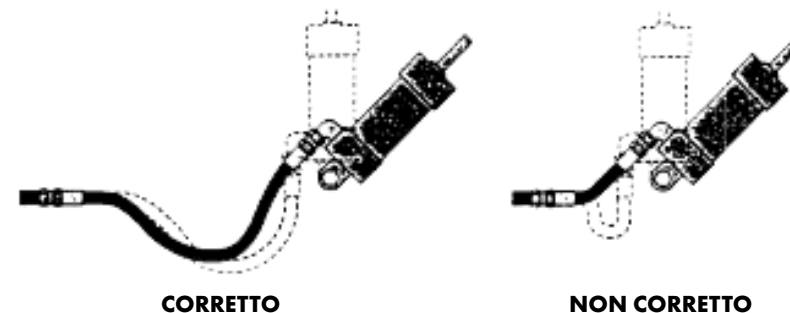

FIG. 4 – ASSORBIMENTO DEL MOTO

4.23.2 - Tubi e tolleranze della macchina.

Progettare il tubo in modo da sopportare le variazioni di lunghezza dovute al moto della macchina ed alle relative tolleranze.



FIG. 5 - TOLLERANZE SUL TUBO

4.23.3 - Variazioni di lunghezza dovute alla pressione.

Progettare il tubo tenendo conto delle variazioni di lunghezza indotte dalla pressione. Non incrociare o fascettare mai tubi ad alta e bassa pressione. La variazione di lunghezza del tubo può causare problemi di usura eccessiva.



FIG.6 - ALLUNGAMENTO E CONTRAZIONE DOVUTE ALLA PRESSIONE

4.24 - Movimenti del tubo e flessione.

Il tubo flessibile permette dei movimenti relativi tra due fonti collegate. Tenere sempre in considerazione questo movimento durante la fase di progettazione. Il numero di cicli giornalieri può influire sulla vita del tubo.

Evitare che il movimento si svolga su più piani o che avvenga in torsione.

In applicazioni dove il tubo deve muoversi o flettere, fare riferimento alle fig. 7A, 7B e 8 e seguire i seguenti suggerimenti:

4.24.1 - Flettere il tubo solo su un piano per evitare torsione.

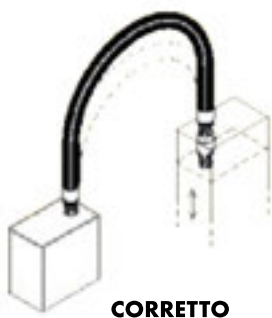

FIG. 7A – FLESSIONE SU UN SOLO PIANO PER ELIMINARE LA TORSIONE

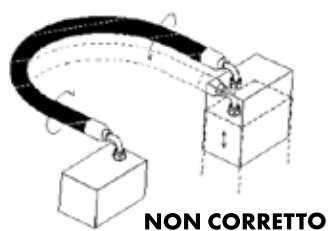

FIG. 7B – FLESSIONE SU UN SOLO PIANO PER ELIMINARE LA TORSIONE

4.24.2 Flettere il tubo solo su un piano per evitare torsione.

Se il tubo flessibile si muove con una flessione complessa, bloccarlo in segmenti separati o fascettarlo in parti che possano flettere solo in un piano

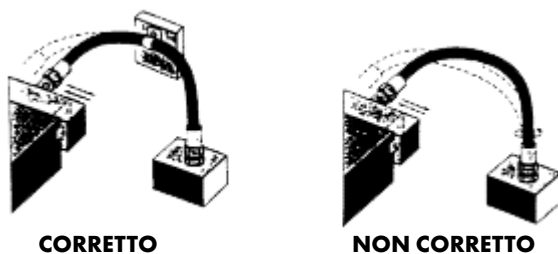

FIG. 8 – EVITARE LA FLESSIONE DEL TUBO SU PIÙ PIANI

5. COSTRUZIONE DEL TUBO RACCORDATO

Il personale addetto alla costruzione del tubo raccordato, deve essere opportunamente preparato sull'impiego dei componenti e delle attrezzature specifiche.

Raccordature ben eseguite, sono fondamentali per la vita del tubo flessibile, mentre una raccordatura male eseguita può creare problemi di sfilamento dai raccordi, e causare un pericoloso "effetto frusta" del tubo o, peggio, creare possibili incendi od esplosioni per i vapori o le nebulizzazioni del fluido trasportato.

5.1 - Controllo dei componenti.

Prima della raccordatura, esaminare i singoli componenti per:

- Configurazione e tipologia
- Pulizia
- Danni sulla copertura
- Intaccature
- Diametri
- Ostruzioni all'interno dei tubi
- Altri difetti visibili
- Danni in genere
- Lunghezze idonee
- Bolle o rigonfiamenti
- Bave di lavorazione

5.2 - Raccordi di estremità.

I tubi flessibili raccordati possono essere realizzati dal costruttore, dall'utilizzatore o dal raccordatore specializzato.

Tubi realizzati secondo la norma SAE J517 da un produttore, possono non essere compatibili con i raccordi prodotti secondo SAE J516 da un altro produttore.

5.3 - Compatibilità dei tubi e dei raccordi.

Porre molta attenzione nella valutazione della compatibilità tubo/raccordo. Non accoppiare tubo e raccordo provenienti da due produttori diversi, senza autorizzazione da parte degli stessi costruttori.

5.4 - Macchine per la raccordatura.

Per la maggior parte dei casi, anche le attrezzature per la raccordatura, non sono uguali da produttore a produttore. Tubi e raccordi prodotti da un costruttore, non dovrebbero essere assemblati con attrezzature di un altro costruttore.

5.5 - Dispositivi di sicurezza.

Durante la produzione del tubo raccordato, utilizzare sempre dispositivi di sicurezza personali, quali occhiali protettivi, mascherine filtranti ed adeguata ventilazione.

5.6 - Riutilizzo dei tubi e dei raccordi.

Nella produzione del tubo raccordato, non utilizzare mai:

- a. Raccordi pressati che si siano sfilati in esercizio
- b. Parti di raccordo recuperate da altri tubi raccordati
- c. Tubi utilizzati per altre operazioni di controllo e verifica (par. 7.7)

5.7 Pulizia interna dei tubi raccordati.

I tubi raccordati possono raccogliere parti contaminanti durante la lavorazione. Se necessario, flussare i tubi fino al raggiungimento del livello di pulizia interna desiderato. (par. 4.13)

6. INSTALLAZIONE E SOSTITUZIONE DEI TUBI FLESSIBILI.

Seguire le seguenti raccomandazioni sia in caso di installazione di tubi raccordati in nuovi impianti, che in caso di sostituzione di tubi raccordati in sistemi già operativi.

6.1 - Controlli preliminari pre-installazione

Eseguire un accurato controllo del tubo flessibile raccordato prima del montaggio, esaminando con cura:

- Lunghezza del tubo raccordato e sua corrispondenza con i dati del progetto
- Aspetto esterno e caratteristiche dimensionali, diametro, marcatura
- Superfici di tenuta dei raccordi e loro grado di finitura (assenza di bave, o altri danni).

NOTA: Prima della sostituzione di un tubo raccordato, verificare sempre la sua corrispondenza all'originale.

6.2 - Movimentazioni del tubo prima dell'installazione.

Maneggiare il tubo raccordato con molta attenzione prima dell'installazione.

Stressare o flettere il tubo sotto del minimo raggio di curvatura, può significativamente causarne una riduzione di vita. Evitare curve strette nelle zone dei raccordi.

6.3 - Angolo di torsione ed orientamento.

La vita di un tubo raccordato assemblato in torsione, si riduce notevolmente. In tali condizioni, si possono anche verificare sfilamenti dei raccordi di estremità.

Per evitare la torsione, controllare che la marcatura sia sempre lineare. In caso di bisogno disegnare una linea di riferimento sulla copertura del tubo. (fig. 9).

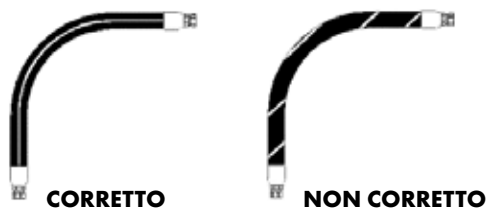

FIG. 9 – ANGOLO DI TORSIONE ED ORIENTAMENTO

6.4 - Sicurezza e protezione.

In molte applicazioni, può essere necessario contenere, coprire o canalizzare il tubo. Tali protezioni aggiuntive, non dovranno in ogni modo, creare ulteriori problemi di sollecitazione o di usura sul tubo raccordato.

6.5 - Installazione.

Seguire le raccomandazioni generali sull'installazione della sezione 4 e verificare che l'alloggiamento del tubo flessibile raccordato nel sistema sia la migliore possibile.

6.6 - Serraggio dei raccordi.

La superficie di tenuta dei raccordi di estremità, è realizzata per offrire la miglior tenuta possibile durante l'impiego del tubo flessibile raccordato.

Ogni tipo di connessione, richiede diversi tipi di carichi torsionali, soprattutto in funzione del materiale e del trattamento superficiale. In questi casi fare sempre uso di chiavi dinamometriche, onde evitare di applicare una "sovratorzione" sul raccordo.

6.7 - Controllo del sistema.

Alla fine dell'installazione, eliminate tutta l'aria all'interno del circuito, prima di metterlo definitivamente in pressione. Seguire le istruzioni del costruttore per prevenire perdite o funzionamenti anomali.

6.7.1 per evitare danni durante il controllo finale del sistema:

- Non toccare alcuna parte del sistema durante la verifica di tenuta
- Mantenersi al di fuori delle aree a rischi durante le prove del sistema
- Riportare la pressione a zero prima di stringere le connessioni.

7. CONTROLLI DI MANUTENZIONE PREVENTIVA.

Un buon programma di manutenzione preventiva sui tubi e sui raccordi, può sensibilmente ridurre gli interventi di manutenzione straordinaria, mantenere il sistema alla sua massima efficienza, riducendo i rischi di danni a persone o cose.

7.1 - Frequenza di controllo.

Per determinare la frequenza dei controlli visivi e funzionali, preventivi, valutare sempre i fattori legati alla tipologia dell'impianto, alla esperienza passata ed ai suggerimenti del costruttore.

7.2 - Controllo visivo (tubi e raccordi).

Controllare visivamente tubi e raccordi per valutare:

- Perdite del tubo o dei raccordi
 - Copertura danneggiata, tagliata od abrasa
 - Rinforzo non protetto
 - Tubi appiattiti, piegati sotto il minimo raggio di copertura, od in torsione
 - Tubi induriti, con copertura scottata o surriscaldati
 - Copertura con escoriazioni, degradata o con poca adesione
 - Raccordi danneggiati, o corrosi
 - Raccordi non propriamente fissati o non pinzati sul tubo
 - Altre non conformità o significativi deterioramenti
- Qualora dovesse sussistere una di queste condizioni, ricontrollare il tubo raccordato o sostituirlo

7.3 Controllo visivo (altri componenti).

Durante il controllo dei tubi e dei raccordi, controllare anche i componenti ad essi collegati per valutare:

- Connessioni e loro tenuta
 - Eventuali danni per mancanza di guide, fascette o guaine protettive
 - Eccessiva sporcizia o frammenti estranei attorno al tubo
 - Fluido del sistema: livello, tipo, pulizia ed eventuale aria intrappolata
- Qualora dovesse sussistere una di queste condizioni, risolvere il problema prima di attivare l'impianto o la macchina operatrice.

7.4 Prove funzionali.

Le prove funzionali servono a determinare il corretto funzionamento del sistema dopo aver verificato l'idoneità dei tubi flessibili ed aver estratto l'eventuale residuo d'aria rimasta nei circuiti.

Condurre le prove funzionali secondo le indicazioni del costruttore.

8. IMMAGAZINAMENTO DEI TUBI FLESSIBILI.

Invecchiamento e sistema di immagazzinamento, possono influire sensibilmente sulla riduzione della vita del tubo flessibile.

8.1 - Controllo dell'invecchiamento.

Instaurare un sistema di controllo sull'invecchiamento per determinare se un tubo flessibile venga utilizzato entro i termini di "vita utile" stabiliti dalle normative.

Per vita utile del tubo flessibile, si intende quel ragionevole periodo di tempo nel quale il tubo mantiene intatte le sue proprietà fisiche stabilite in fase di progettazione.

Immagazzinare i tubi flessibili in modo da controllarne l'invecchiamento, utilizzandoli con la metodologia del primo in ingresso, primo in uscita (first in, first out), avvalendosi anche delle date di fabbricazione riportate sul tubo.

Secondo quanto specificato dalla norma SAE J 517:

- Per vita utile di un tubo flessibile in gomma o di un tubo raccordato, si intende un periodo di 40 trimestri (10 anni), fermo restando le verifiche ispettive e di pressione per valutarne l'idoneità.
- La vita utile dei tubi termoplastici e dei tubi in PTFE, è da considerarsi illimitata

8.2 - Immagazzinamento.

Stoccare i tubi flessibili in un ambiente con poca luminosità, possibilmente ben areato, secco e con tappi alle estremità.

Nell'immagazzinamento dei tubi flessibili, fare attenzione a non provocare dei danni che potrebbero ridurre la vita del tubo, seguendo (ove possibile) le istruzioni del fornitore.

Di seguito un elenco di fattori che possono influire sulla vita dei tubi immagazzinati:

- Temperatura
- Ozono
- Olio
- Liquidi corrosivi e sostanze nebulizzate
- Roditori
- Umidità
- Raggi ultravioletti
- Solventi
- Insetti
- Materiali radioattivi

Se dovessero insorgere problemi relativi all'impiego di tubi o tubi flessibili, adottare i seguenti accorgimenti:

- Flettere il tubo fino al raggio minimo di curvatura e paragonarlo ad un tubo nuovo. Dopo la curvatura, esaminare attentamente il

sottostrato la copertura per verificare l'eventuale presenza di tagli o screpolature. Se si dovesse verificare anche un minimo difetto, non esitare a scartare il tubo.

b. Se il tubo ha un rinforzo metallico ed appare particolarmente rigido, o si sentono rumori proveniente dall'interno all'atto della sua flessione, controllare immediatamente se si è formata della ruggine, asportando una parte della copertura, per migliorare la visione. Rinforzi arrugginiti, sono un'altra causa per scartare il tubo.

c. Dovessero sussistere ulteriori dubbi sulla qualità del prodotto, contattare il costruttore affinché possa condurre appropriate verifiche di idoneità.

DATI TECNICI SULL'IMPIEGO DEI TUBI FLESSIBILI

1. RAPPORTO TRA DIAMETRO INTERNO IN MILLIMETRI, POLLICI E SIZE

Diametro interno Internal Diameter		
mm	Inch	size
3,22	1/8	-02
4,76	3/16	-03
6,35	1/4	-04
7,93	5/16	-05
9,52	3/8	-06
12,70	1/2	-08
15,87	5/8	-10
19,05	3/4	-12
25,40	1	-16
31,75	1-1/4	-20
38,10	1-1/2	-24
50,80	2	-32
63,50	2-1/2	-40
76,20	3	-48

2 - FLESSIBILITA' E RAGGIO DI CURVATURA

Flessibilità e raggio minimo di curvatura sono fattori molto importanti nella vita del tubo flessibile.

Il raggio minimo di curvatura è importante per determinare la lunghezza del tubo flessibile che può permettere al tubo di flettere senza problemi:

$$\frac{A}{360} \times 2 \pi B = L$$

dove:

A = Angolo di curvatura

B = Raggio di curvatura del tubo

L = Lunghezza minima del tubo da flettere (π = (Pi-greco) = 3.14)

Esempio: la LUNGHEZZA libera di un tubo che deve fare una curva a 60° avente raggio minimo di curvatura di 80 mm:

$$L = (60/360) \times 2 \times 3,14 \times 80$$

$$L = 83,74$$

Il raggio di curvatura deve essere uguale o maggiore del raggio minimo di curvatura specificato per quell tipo di tubo flessibile.

TIPI DI SVASATURA

RACCORDI A PRESSARE GAS/BSP 60°

British Standard Pipe
Filetto Whitworth
Cono 60°
BS 5200

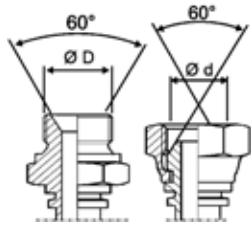

RACCORDI A PRESSARE NPT

National Pipe Thread Fine
Tenuta tramite Filetto Conico
ANSI B2.1 e B2.2

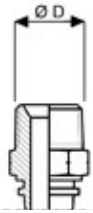

RACCORDI A PRESSARE JIC 74°

Joint International Conference
Filetto Cilindrico (UNF)
Cono 74°
SAE J514

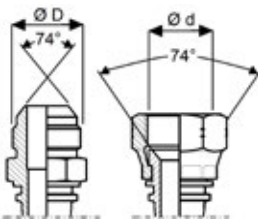

RACCORDI A PRESSARE ORFS

British Standard Pipe
Filetto Whitworth
Cono 60°
BS 5200

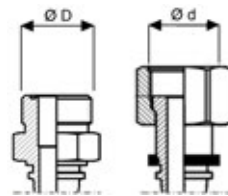

RACCORDI A PRESSARE METRICI 24°

Serie leggera (DKOL) e serie
pesante (DKOS)
Filetto Metrico
Cono 24°
Raccordo Femmina
con O-ring
DIIN 2353

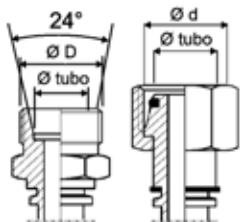

RACCORDI A PRESSARE GAS/BSP 60°

Filetto Metrico
Cono 60°

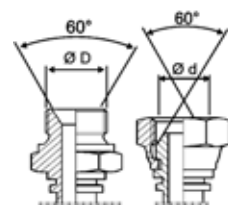

RACCORDI A PRESSARE JIS 60°

Filetto Metrico (Komatsu)
Filetto GAS/BSP (Toyota)
Cono 60°
JIS B8363

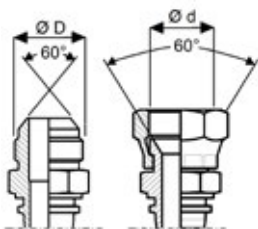

RACCORDI A PRESSARE FLANGE SAE

SAE J518
3 = 3.000 PSI
6 = 6.000 PSI
9 = 9.000 PSI ("Supercat")

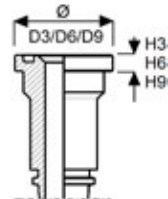

MISURAZIONE FILETTI

Ø Filetto Maschio Ø Filetto Femmina

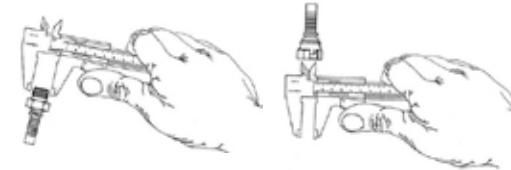

FILETTO METRICO

Filetto mm	Ø Maschio mm	Ø Femmina mm
M 10x1	10	8,9
M 12x1,5	12	10,4
M 14x1,5	14	12,4
M 16x1,5	16	14,4
M 18x1,5	18	16,4
M 20x1,5	20	18,4
M 22x1,5	22	20,4
M 24x1,5	24	22,4
M 26x1,5	26	24,4
M 30x1,5	30	28,4
M 36x1,5	36	34,4
M 38x1,5	38	36,4
M 45x1,5	45	43,4
M 52x1,5	52	50,4

FILETTO METRICO DKOL/DKOS

Filetto mm	Ø Codolo Serie L	Ø Codolo Serie S	Ø Maschio	Ø Femmina
M 12x1,5	6L		12	10,4
M 14x1,5	8L	6S	14	12,4
M 16x1,5	10L	8S	16	14,4
M 18x1,5	12L	10S	18	16,4
M 20x1,5		12S	20	18,4
M 22x1,5	15L	14S	22	20,4
M 24x1,5		16S	24	22,4
M 26x1,5	18L		26	24,4
M 30x2,0	22L	20S	30	27,8
M 36x2,0	28L	25S	36	33,8
M 42x2,0		30S	42	39,8
M 45x2,0	35L		45	42,8
M 52x2,0	42L	38S	52	49,8

FILETTO GAS / BSP

Filetto mm	Ø Maschio mm	Ø Femmina mm
G 1/8"-28	9,7	8,6
G 1/4"-19	13,2	11,4
G 3/8"-19	16,7	15,0
G 1/2"-14	21,0	18,6
G 5/8"-14	22,9	20,6
G 3/4"-14	26,4	24,1
G 1"-11	33,3	30,3
G 1.1/4"-11	41,9	39,0
G 1.1/2"-11	47,8	44,9
G 2"-11	59,6	56,7

FILETTO ORFS

Filetto mm	Ø Maschio mm	Ø Femmina mm	Oring mm
9/16"-18	14,3	12,8	7,66X1,78
11/16"-16	17,5	15,7	9,25X1,78
13/16"-16	20,6	18,9	12,42X1,78
1"-14	25,4	23,4	15,60X1,78
1.3/16"-12	30,2	27,9	18,77X1,78
1.7/16"-12	36,5	34,2	23,52X1,78
1.11/16"-12	42,9	40,6	29,87X1,78
2"-12	50,8	48,5	37,82X1,78

FILETTO JIC

Filetto mm	Ø Maschio mm	Ø Femmina mm
7/16"-20	11,1	9,7
1/2"-20	12,7	11,3
9/16"-18	14,3	12,8
3/4"-16	19,1	17,3
7/8"-14	22,2	20,3
1.1/16"-12	27,0	24,7
1.3/16"-12	30,2	27,9
1.5/16"-12	33,3	31,0
1.5/8"-12	41,3	39,0
1.7/8"-12	47,6	45,3
2.1/2"-12	63,5	61,5

